

PAYA LEBAR METHODIST GIRLS' SCHOOL (PRIMARY)

PRELIMINARY EXAMINATION 2022

PRIMARY SIX

SCIENCE

BOOKLET A

NAME : _____ ()

CLASS : P6 _____

DATE : 23 August 2022

TOTAL TIME FOR BOOKLETS A & B: 1 hour and 45 minutes

INSTRUCTIONS TO PUPILS

DO NOT OPEN THIS BOOKLET UNTIL YOU ARE TOLD TO DO SO.

ANSWER ALL QUESTIONS.

Section A (28 x 2 = 56 marks)

For each question from 1 to 28, four options are given. One of them is the correct answer. Make your choice (1, 2, 3 or 4) and shade your answer on the Optical Answer Sheet.

1. Which of the following characteristics are found in insects, but not in other animals?

- A They lay eggs.
- B They have wings.
- C They have six legs.
- D They have three body parts.

- (1) A and B only
- (2) B and C only
- (3) C and D only
- (4) A and D only

2. Study the three different cells shown below.

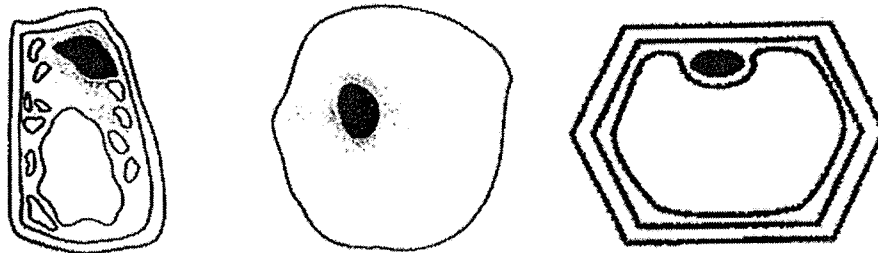

Which one of the following statements is true about all the three cells?

- (1) They can photosynthesise.
- (2) They have regular shapes.
- (3) They contain nucleus and cell wall.
- (4) They contain cytoplasm and cell membrane.

3. The diagram shows two flowers.

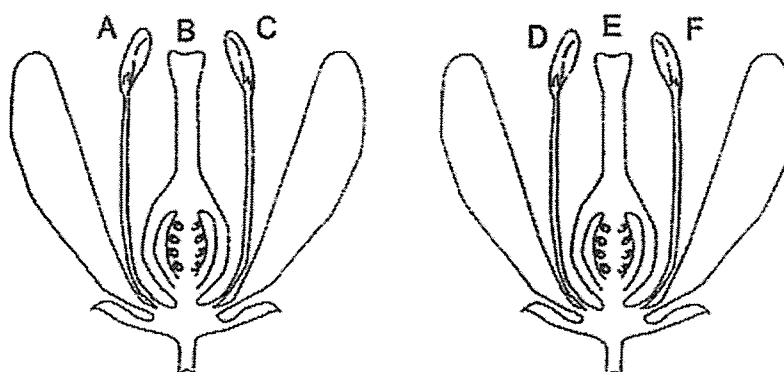

Pollination takes place when pollen grains are transferred from _____.

- (1) A to B and B to D
- (2) C to A and C to E
- (3) C to F and B to E
- (4) D to B and F to E

4. Which one of the following correctly shows the amount of gases in the air that we breathe out as compared to the air that we breathe in?

	Amount of oxygen	Amount of carbon dioxide	Amount of water vapour
(1)	increased	decreased	increased
(2)	increased	decreased	decreased
(3)	decreased	increased	increased
(4)	decreased	increased	decreased

5. Study the table below.

	Parts of the digestive system			
	P	Q	R	S
Digestion takes place?		Yes	Yes	Yes
Removes water from food?	Yes			
Passes food to the bloodstream?			Yes	

Which of the following correctly shows the parts labelled P, Q, R and S?

(1)

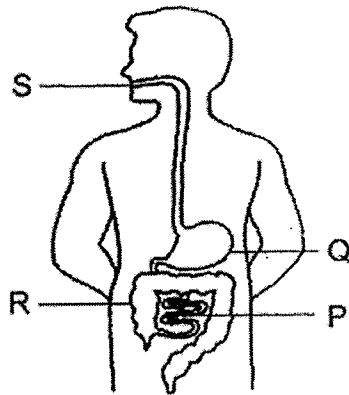

(2)

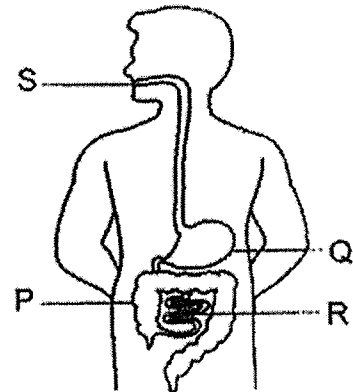

(3)

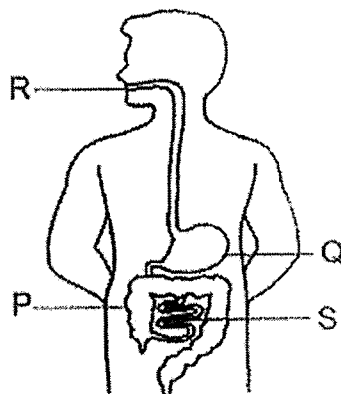

(4)

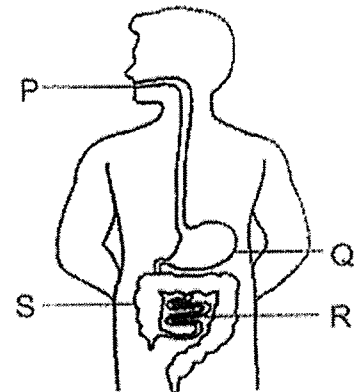

6. A plant was placed in a beaker of blue-coloured water. After one day, the stem was cut. A section of the stem is shown.

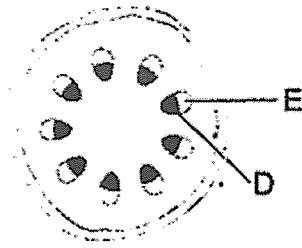

It was observed that tube D turned blue but not tube E. Why?

- (1) Tube D transports food from the roots to all parts of the plant.
- (2) Tube D transports water from the roots to all parts of the plant.
- (3) Tube D transports food from the leaves to all parts of the plant.
- (4) Tube D transports water from the leaves to all parts of the plant.

7. Dave set up an experiment. He wrapped three similar leaves in different types of plastic bags. The plastic bags were of the same size. He left the plant under bright light for some time.

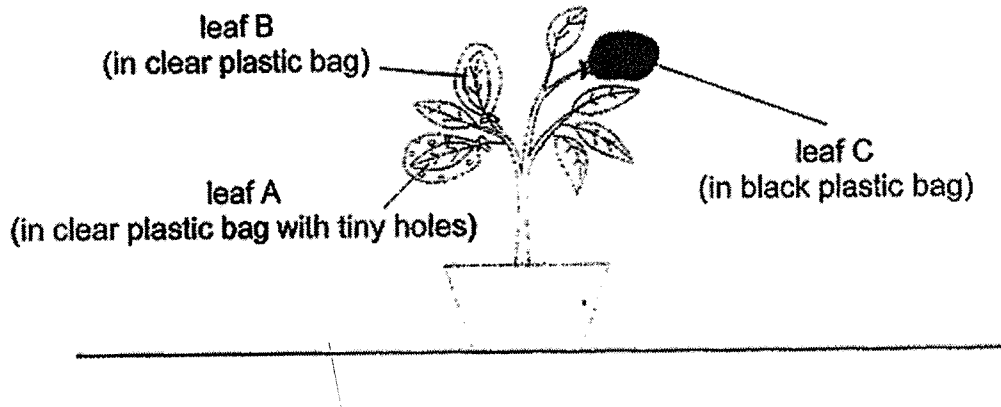

Which graph correctly represents the amount of carbon dioxide in the plastic bags after several hours?

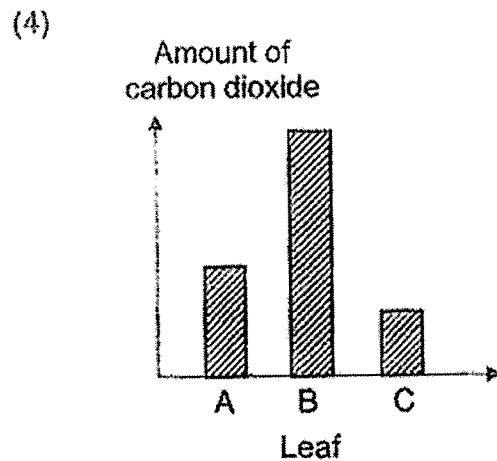
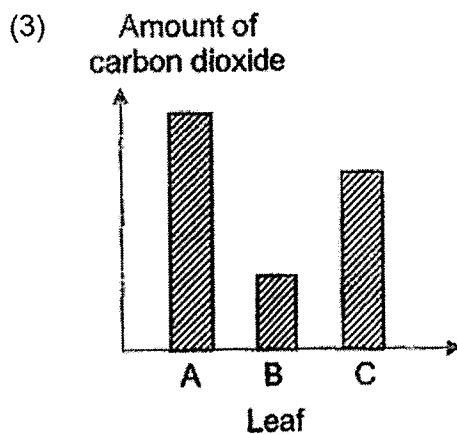
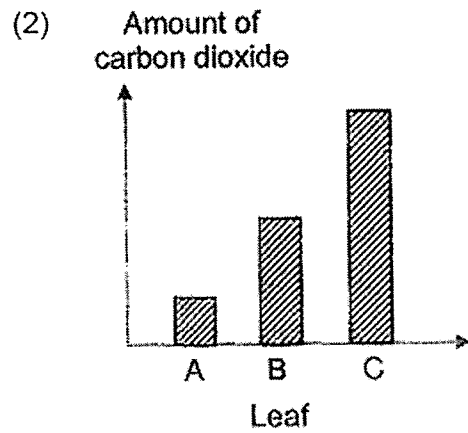
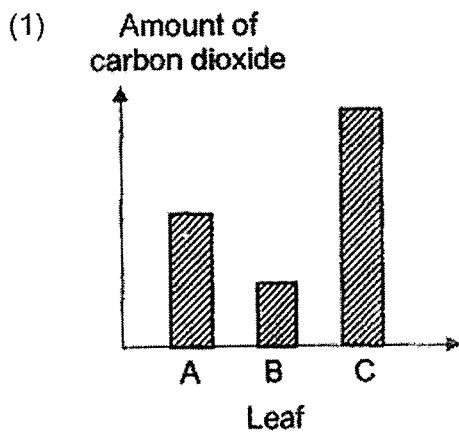

3. The diagram below shows a fruit tree with some organisms.

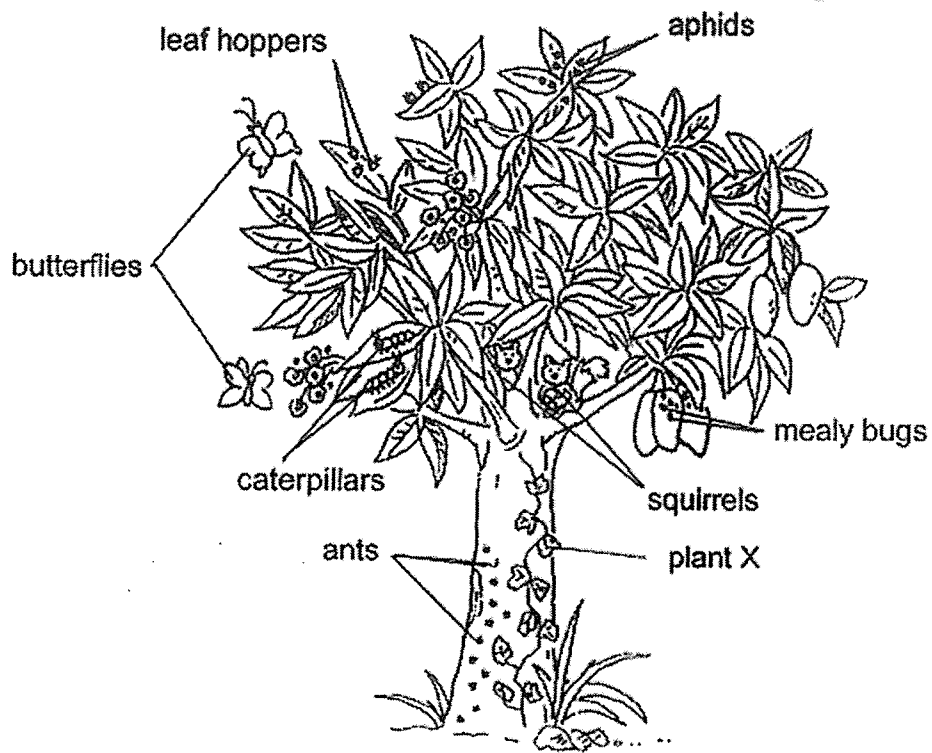

Based on the diagram above, which statement is true?

- (1) There are six animal populations.
- (2) There are eight communities living on the tree.
- (3) There are four plant populations living on the tree.
- (4) There are less than 30 organisms living on the tree.

9. Study the food web below.

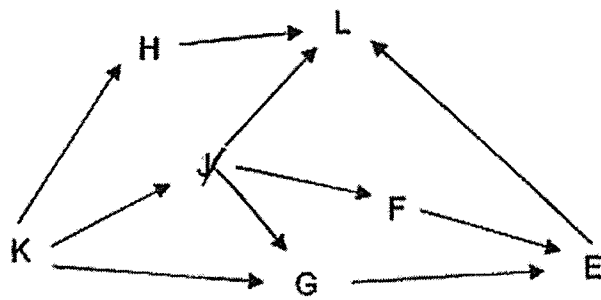

If the whole population of J is killed by a disease, which of the following populations will be most affected?

- (1) F
- (2) G
- (3) K
- (4) L

10. A close-up view of a leaf under a microscope shows tiny openings on the underside of the leaf.

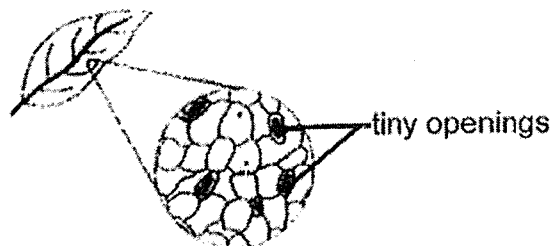

When there is light, the tiny openings become bigger. However, in the presence of very strong light over a long period of time, the tiny openings will decrease in size and finally close.

Which of the following best explains the change in the size of the tiny openings?

- (1) The plant is preventing itself from losing too much water.
- (2) The plant is preventing itself from absorbing too much light.
- (3) The plant has made enough food and completed photosynthesis.
- (4) The plant has absorbed sufficient oxygen to carry out photosynthesis.

11. Which of the following shows the correct order of stages in the life cycle of a non-flowering plant?

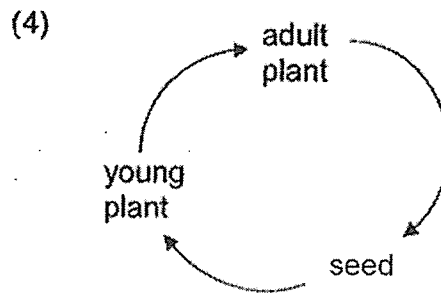
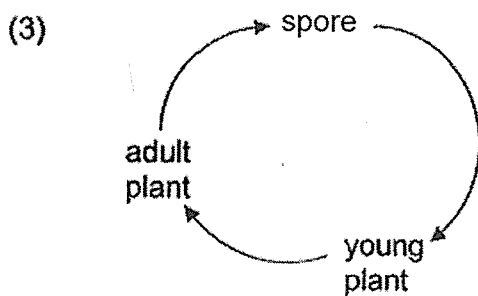
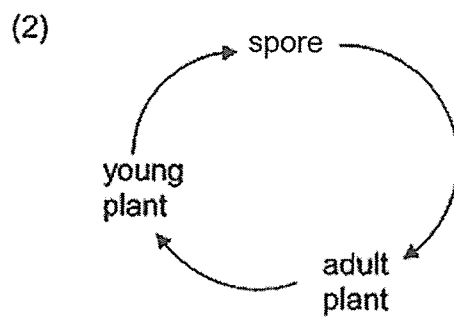
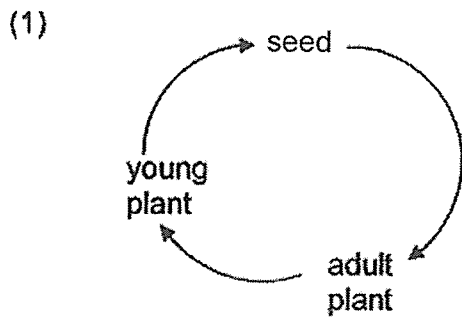

12. Greenhouse gases may be produced when fuels are burnt for energy. The table shows some information about three types of fuels, X, Y and Z.

Fuel	Number of years fuel can last	Energy produced	Amount of greenhouse gases produced
X	50-60	low	high
Y	50-60	medium	medium
Z	50-60	high	low

Which of the following cannot be concluded based on the information above?

- (1) X is the least environmentally friendly fuel.
- (2) Acid rain forms only from the burning of X and Y.
- (3) X, Y and Z are non-renewable sources of energy.
- (4) Burning of X, Y and Z contributes to global warming.

13. Sarah drew the diagram below to show the blood flow in some parts of the human body.

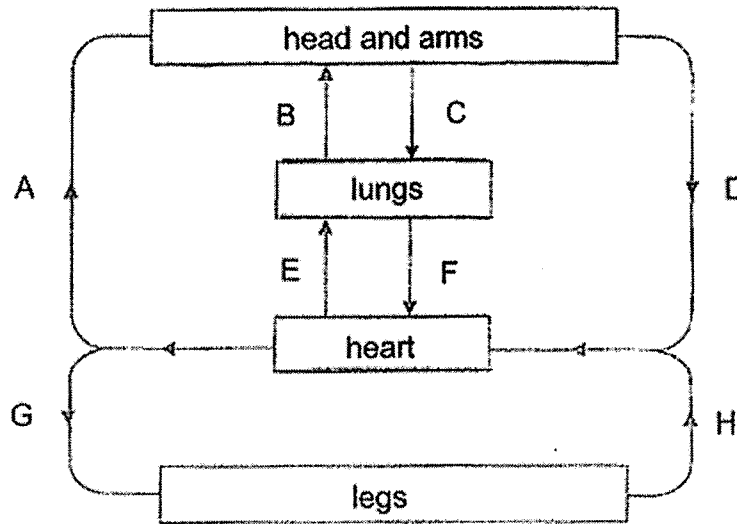

Which two arrows were not drawn correctly?

- (1) A and D only
 - (2) B and C only
 - (3) E and F only
 - (4) G and H only
14. Fertilisers help tiny floating plants to grow quickly and cover the surface of ponds. The following events took place when fertilisers from a farm entered a nearby pond.

- A The population of fish decreased.
- B The amount of oxygen in the water decreased.
- C The population of underwater plants decreased.
- D Sunlight could not reach the organisms in the pond.

Which of the following shows the correct order of events?

- (1) A, B, C, D
- (2) A, B, D, C
- (3) D, B, A, C
- (4) D, C, B, A

15. A wall along racing tracks is made up of old car tyres tied together. This helps to protect spectators and drivers should accidents occur.

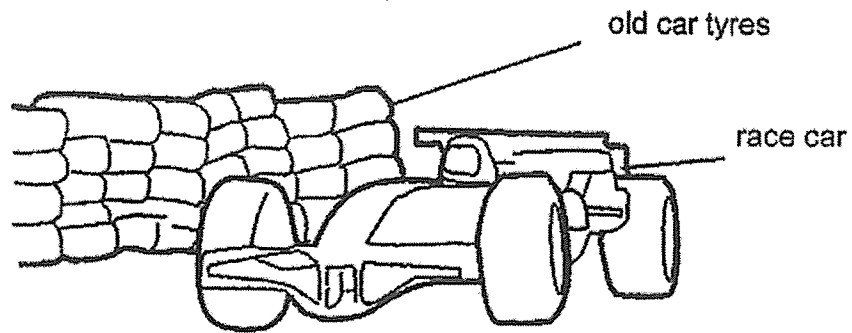

Which properties of the old car tyres help to ensure safety?

- (1) strength and flexibility
 - (2) waterproof and flexibility
 - (3) strength and transparency
 - (4) waterproof and transparency
16. The diagram below shows the movement of water in the environment.

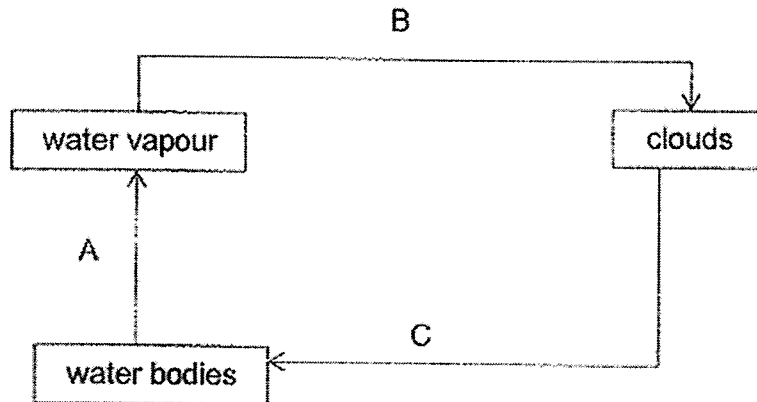

Based on the diagram given, which of the following correctly shows the change in state of water?

	From liquid to gas	From gas to liquid
(1)	C	A
(2)	A	B and C
(3)	A	B
(4)	B and C	A

17. A syringe contained air and some water. Ben blocked the opening of the syringe as shown below.

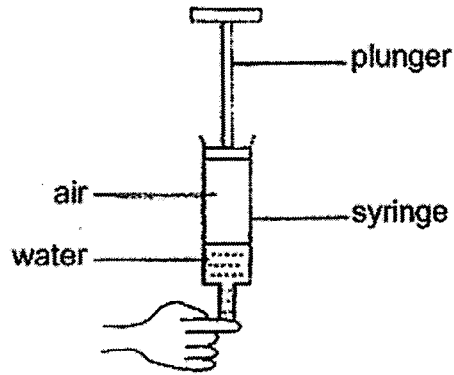

Which of the following best explains why Ben can push the plunger downwards?

- (1) Air has no definite shape.
- (2) Air has no definite volume.
- (3) Water has no definite shape.
- (4) Water has no definite volume.

18. Study the circuits below. In which circuit will only one bulb light up?

(1)

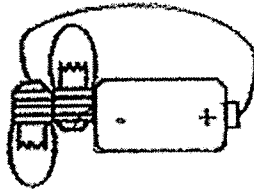

(2)

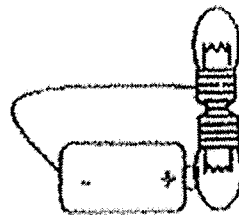

(3)

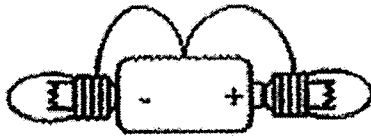

(4)

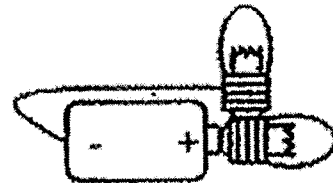

19. Joseph placed object K on a weighing scale and the scale showed a reading of 10 units. He then placed a bar magnet 2 cm directly above object K and the scale showed a reading of 12 units.

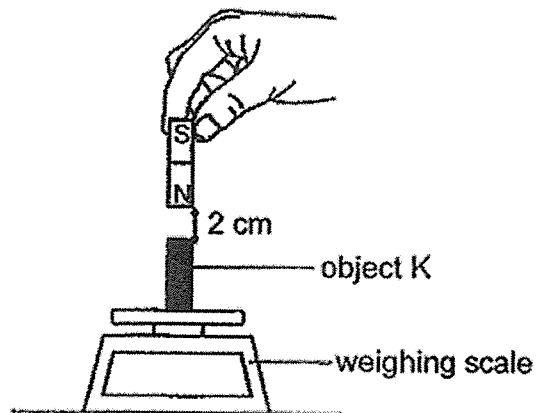

He then flipped the bar magnet over and held it 2 cm directly above object K.

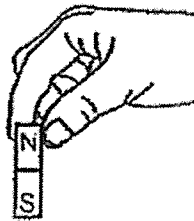

What would be the new reading on the weighing scale?

- (1) 0 unit
- (2) 12 units
- (3) 15 units
- (4) 22 units

20. Chris moved between a wall and a lamp as shown below.

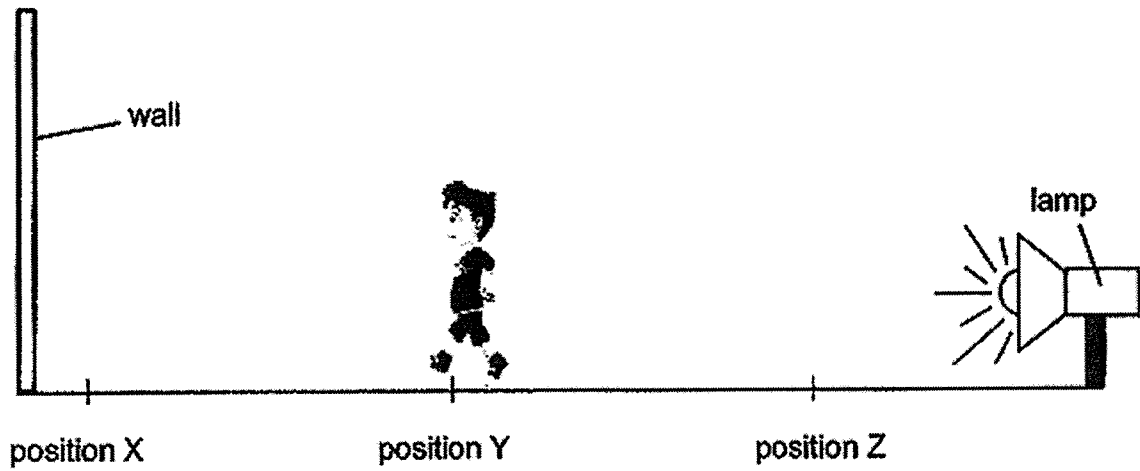

Which graph shows the correct sizes of the shadows when Chris was at the various positions?

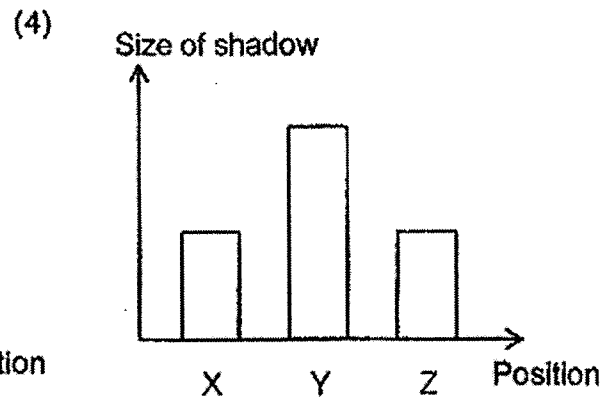
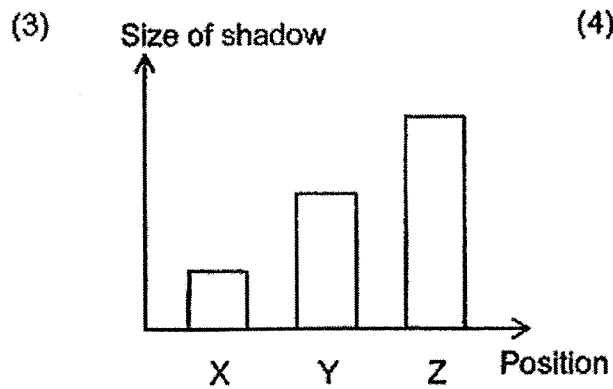
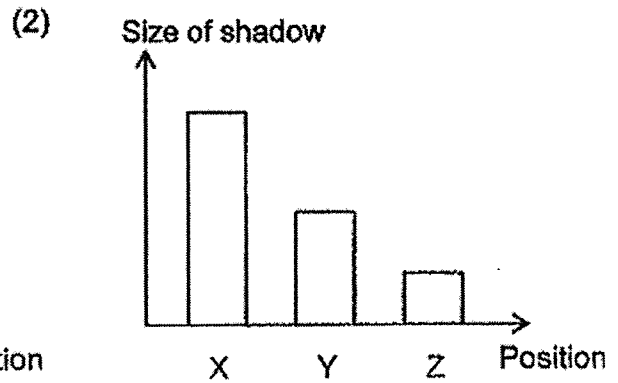
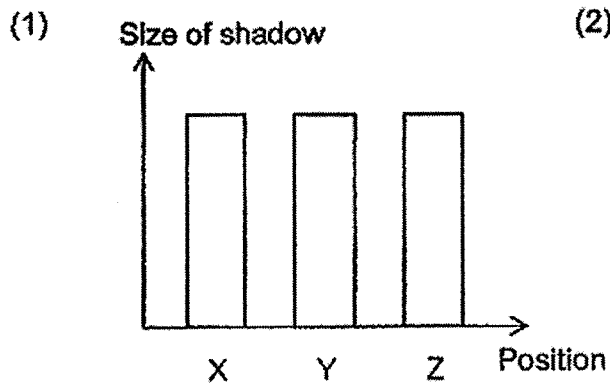

21. A toy track was set up as shown below. When the toy car was released, it started moving along the track from A, down to B, up to C, before leaving at D.

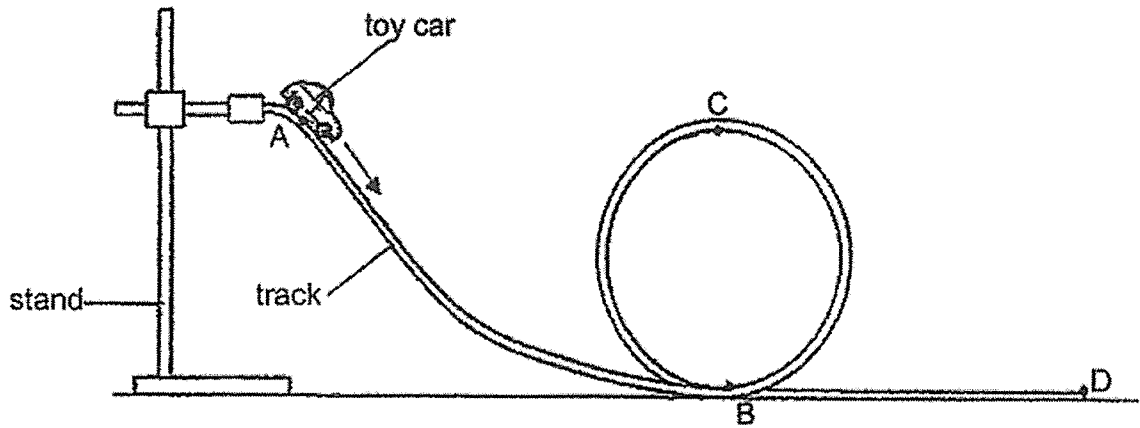

At which points of the track would the amount of gravitational force acting on the toy car be the same?

- (1) A and C only
 - (2) A and D only
 - (3) B and D only
 - (4) A, B, C and D
22. Study the circuit below. Bulbs J, K, L, M and N are identical bulbs.

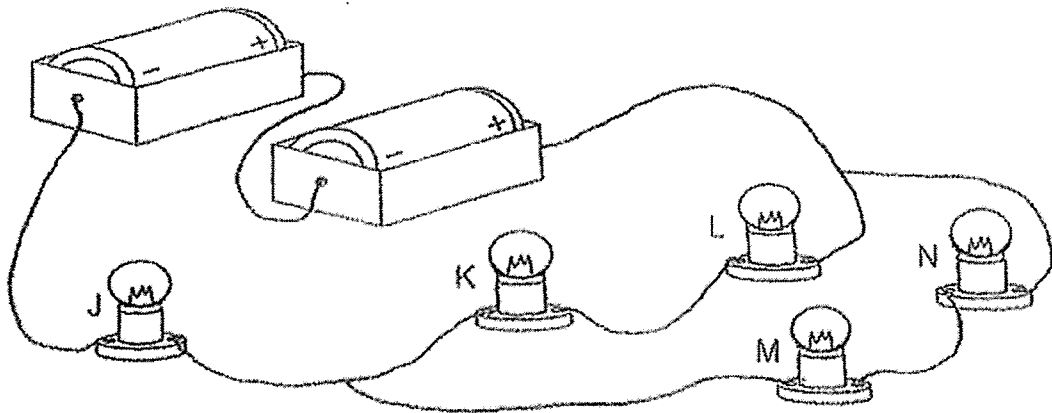

Which two bulbs should be removed so that the remaining three bulbs will light up with equal brightness?

- (1) K and N
- (2) K and L
- (3) L and M
- (4) J and K

23. The table below shows the melting and boiling points of substances A, B, C and D.

Substance	Melting point (°C)	Boiling point (°C)
A	35	55
B	33	85
C	21	180
D	8	31

Which of the substances will be liquid at 34°C?

- (1) A only
 - (2) A and D only
 - (3) B and C only
 - (4) B, C and D only
24. Which of the following is a possible effect on the water cycle when the temperature of the environment decreases?
- (1) Evaporation of water decreases resulting in less rain.
 - (2) Condensation of water vapour increases resulting in less rain.
 - (3) Condensation of water vapour decreases resulting in more clouds.
 - (4) Evaporation of water increases resulting in more water vapour in the air.

25. Balls P and Q are placed on a plastic surface and a push is exerted on ball Q as shown in the diagram below.

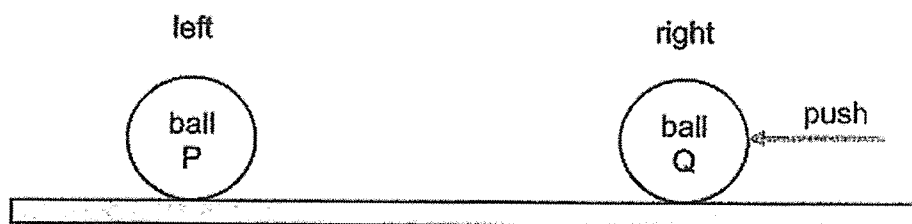

When ball Q hits ball P, ball Q moves back to the right and ball P remains stationary. Which of the following actions will **not** move ball P to the left?

- (1) Use less force to push ball Q
- (2) Replace ball P with a lighter ball
- (3) Replace ball Q with a heavier ball
- (4) Use a greater force to push ball Q

26. Patricia poured an equal amount of tap water into three identical beakers X, Y and Z. She added seven ice cubes into each beaker. She then wrapped each beaker with layers of identical bubble wraps of the same size as shown in the table below.

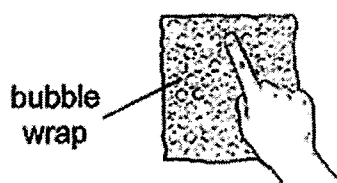

Beaker	Layers of bubble wraps around beaker
X	15
Y	3
Z	8

After some time, she removed all the bubble wraps and made her observations as shown below.

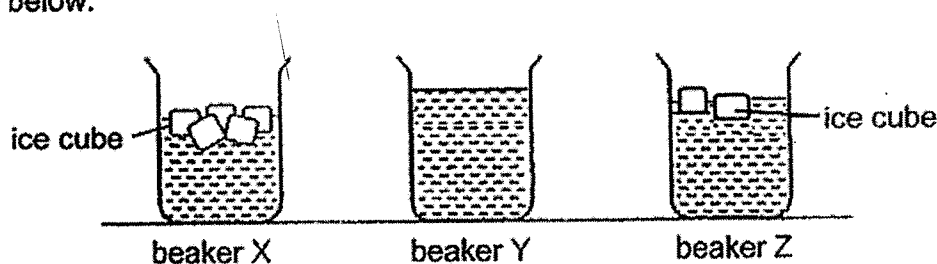

Which statement best explains Patricia's observations?

- (1) The ice cubes in beaker Z gained more heat from the surroundings than the ice cubes in beaker Y.
- (2) The more number of layers of bubble wraps used, the more heat is trapped to prevent the ice cubes from melting.
- (3) Beaker Y has the least number of layers of bubble wraps used so the greatest amount of heat is lost from the ice cubes.
- (4) Beaker X has the most number of layers of bubble wraps used so the ice cubes in it gained the least amount of heat from the surroundings.

27. When Ali placed two identical objects, P and Q, on two springs of the same length, A and B, spring B compressed more than spring A.

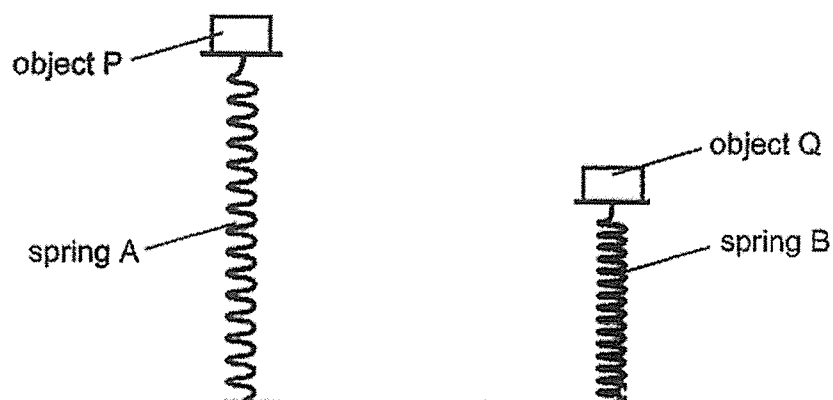

Which of the following statements are true?

- A Spring A is stiffer than spring B.
 - B Spring B has a greater mass than spring A.
 - C Elastic spring force is acting on objects P and Q.
 - D There is more force acting on spring B than spring A.
-
- (1) A and B only
 - (2) A and C only
 - (3) B and D only
 - (4) A, C and D only

28. Block S is released from the top of a smooth slope. It moves down and hits block Q at the bottom of the slope.

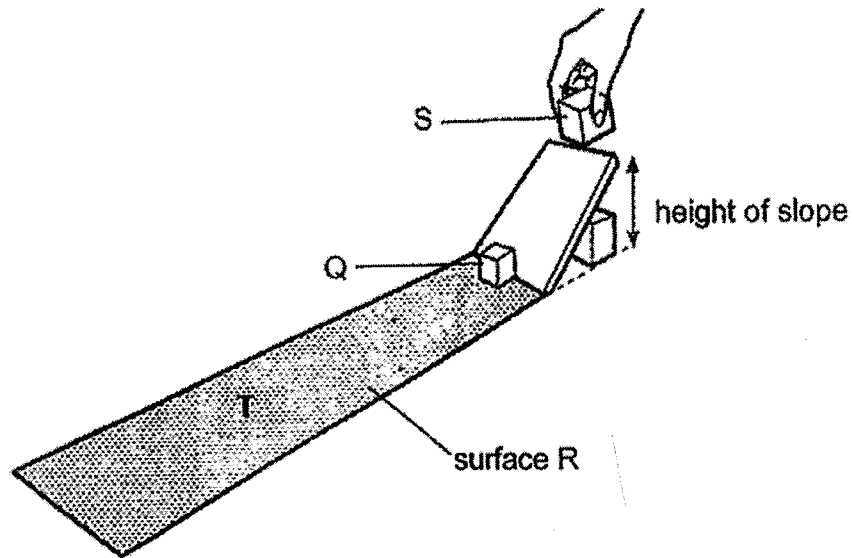

After being hit by S, Q slides along surface R before coming to a stop at position T.

Which of the following changes can increase the distance moved by Q along surface R?

- (1) increasing the length of R
- (2) increasing the roughness of R
- (3) increasing the width of the slope
- (4) increasing the height of the slope

END OF BOOKLET A

PAYA LEBAR METHODIST GIRLS' SCHOOL (PRIMARY)

PRELIMINARY EXAMINATION 2022

PRIMARY SIX

SCIENCE

BOOKLET B

NAME : _____ ()

CLASS : P6 _____

DATE : 23 August 2022

TOTAL TIME FOR BOOKLETS A & B: 1 hour and 45 minutes

BOOKLET A	/ 56
BOOKLET B	/ 44
TOTAL	/ 100

Parent's Signature: _____

INSTRUCTIONS TO PUPILS

**DO NOT OPEN THIS BOOKLET UNTIL YOU ARE TOLD TO DO SO.
Answer all questions.**

SECTION B: 44 Marks

For questions 29 to 40, write your answers in the spaces provided.

The number of marks available is shown in brackets [] at the end of each question or part question.

29. Bacteria C can be found on cooked food and can cause food to spoil when present in large numbers. Priya conducted an experiment to find out how quickly bacteria C can reproduce on cooked rice when it is kept at different temperatures. Her results are shown below.

Temperature at which bacteria C is kept (°C)	Average number of bacteria C (unit)	
	At start of experiment	After 6 hours
5	1	1
10	1	35
20	1	255
30	1	4046

- (a) Based on Priya's results, what do bacteria need to reproduce? [1]

- (b) Based on Priya's results, explain why it is not suitable for cooked rice to be kept at 30°C. [1]

- (c) Suggest why Priya had to use the same amount of cooked rice and the same type of cooked rice for her experiment. [1]

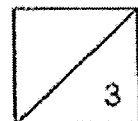

30. Linus, Myra and Netty compared the life cycle of a cockroach with that of a mosquito and made the following statements.

Linus: Both animals have a three-stage life cycle.

Myra: Both animals have wings in the adult stage.

Netty: The young of both animals resemble the adult.

(a) Which two students made the wrong statements? Give a reason why their statements are wrong. [2]

(i) Name of student: _____

Reason: _____

(ii) Name of student: _____

Reason: _____

The adult mosquito can spread diseases to humans. However, it is difficult to get rid of the adult mosquito.

(b) Based on the life cycle of the mosquito, explain how, if each of these actions are carried out regularly, would help to reduce the number of mosquitoes before they reach the adult stage. [2]

(i) Action 1: Spray oil on water in drains

(ii) Action 2: Remove stagnant water that collects in flower pots

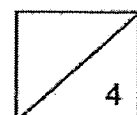

31. Study the food web below.

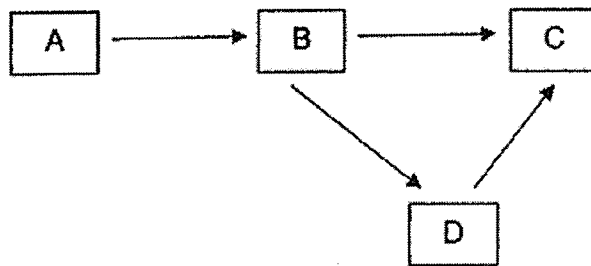

The young of organism B feeds on the leaves of organism A while its adult feeds on the nectar of organism A.

(a) Identify a prey and predator in the food web. [1]

(b) What will happen to the population of organism C if the population of organism B decreases? Give a reason for your answer. [1]

(c) Based on the information given above, explain why it is possible for organism A to become extinct if organism B becomes extinct. [1]

(d) How do the different feeding habits of the young and the adult of organism B increase their chances of survival? [1]



32. The diagram shows white and black moths. The moths frequently rest on tree trunks.



The bark of tree trunks in Town X was light in colour.

(a) Which moth would survive better in Town X? Explain your answer. [1]

(b) After several years, air pollution caused the bark of tree trunks in Town X to turn dark in colour.

Based on this information, what would happen to the population size of both moths in Town X after several years? Explain your answer. [2]

The life cycle of the moth is similar to that of the butterfly. The graph shows the mass of a moth during different stages of its life cycle.

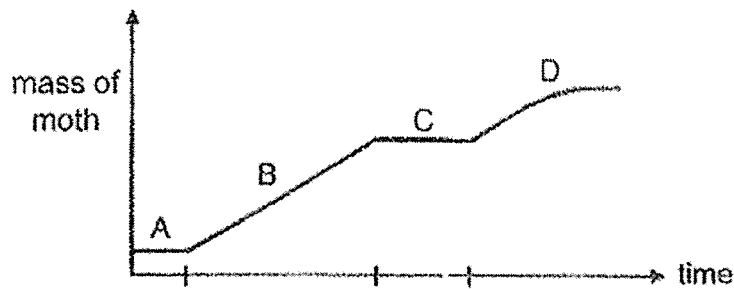

(c) Name stage C of the life cycle of the moth. Suggest a reason why there is no gain in mass during stage C. [1]

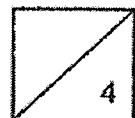

33. Serene wanted to find out how the amount of light affects the rate of photosynthesis of a water plant as shown below.

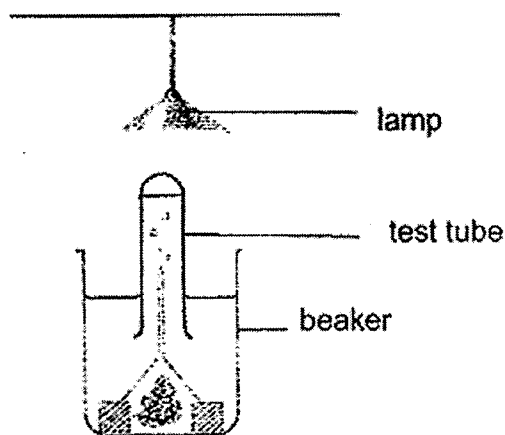

After one hour, she noticed that a gas was collected in the test tube.

- (a) She repeated the experiment with some water worms and the same water plant in the tube. The gas collected increased for the same period of time. Explain why. [1]

- (b) Explain why switching off the lamp would cause the worms to die faster than when the lamp was switched on. [1]

She repeated the experiment with two similar set-ups with two different plants, A and B. She recorded her results in the table below.

Light intensity (units)	Amount of gas collected (cm ³)	
	Plant A	Plant B
10	2	4
20	5	10
30	9	28

- (c) Which plant, A or B, grow better in areas where there is less light? Explain your answer. [1]



34. Dorcas made two paper airplanes with different wingspan.

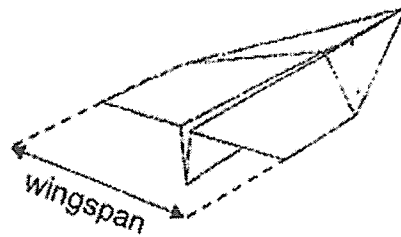

She released each airplane from the same height and location and recorded the results as shown below.

Length of wingspan (cm)	4	8
Time taken for airplane to reach the ground (s)	9	15
Distance travelled by the airplane (cm)	32	57

- (a) What is the relationship between the length of wingspan and the time taken for the airplane to reach the ground? [1]

Dorcas found fruits X and Y below in a garden.

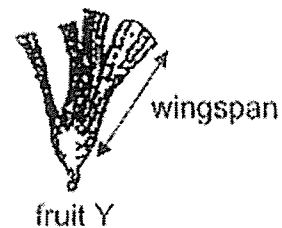
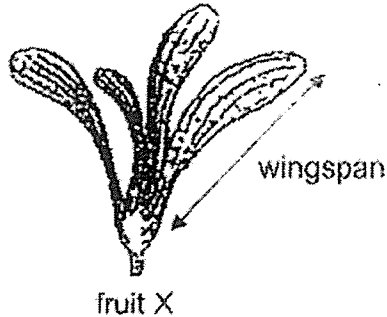

- (b) Based on the above experiment, which young plant of the fruits, X or Y, is not likely to experience overcrowding? Explain your answer. [1]

The diagram below shows the growth of the seedlings of plants S and T found at different distances away from the parent plant.

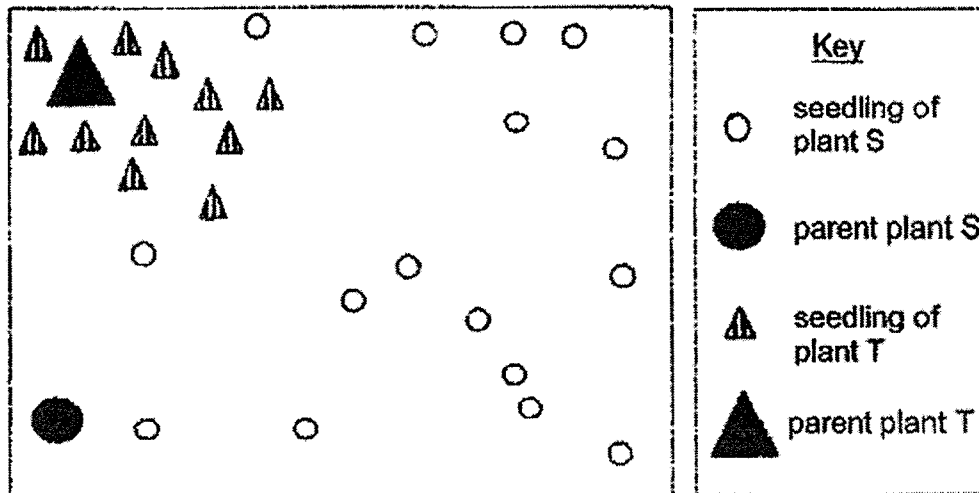

The following fruits, 1 and 2, belongs to either plant S or plant T.

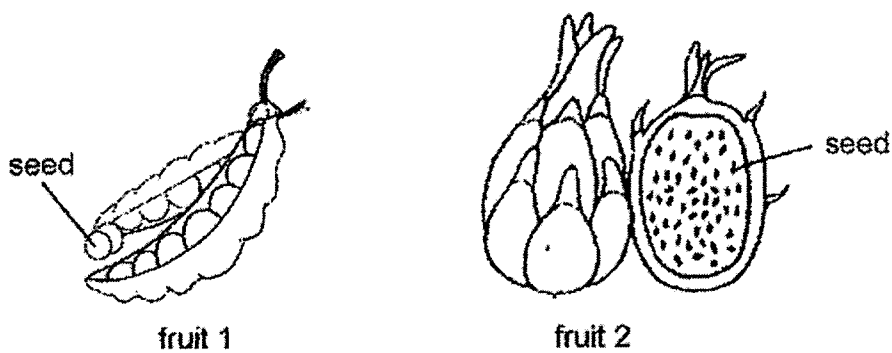

- (c) Based on the diagram and information above, which fruit, 1 or 2, belongs to plant S? Explain your answer. [2]

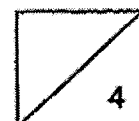

35. Dennis conducted an experiment to investigate whether light can pass through three sheets, A, B and C that were made of different materials. The sheets were arranged in two set-ups X and Y as shown below.

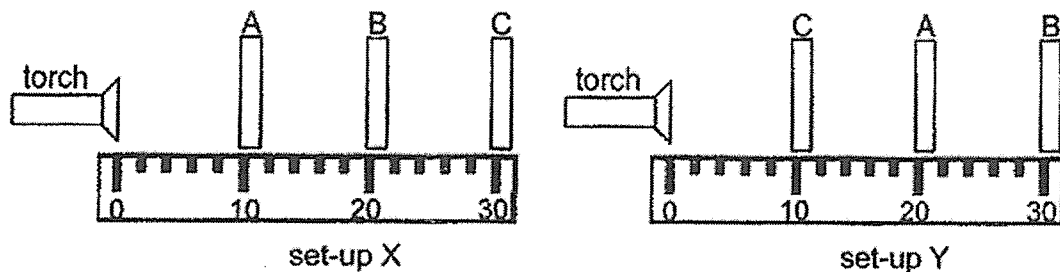

The distance travelled by the light for each set-up was measured and the results are shown in the graph below.

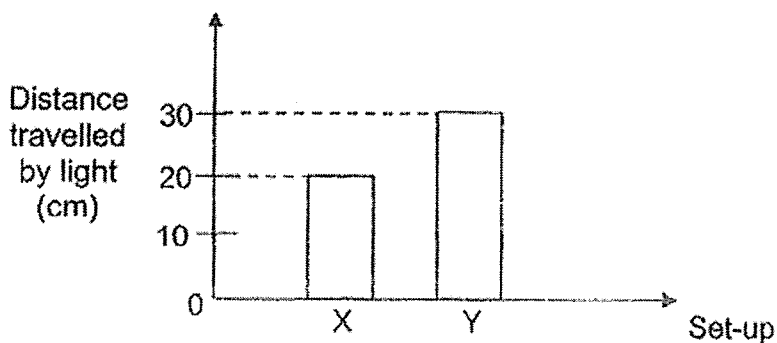

- (a) What would Dennis observe about the distance travelled by the light when sheet B is placed at 10cm? Give a reason for your answer. [2]

- (b) From the graph above, what could Dennis conclude about sheets A and C? [1]

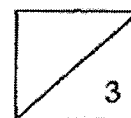

36. Victor has an electric toy tractor, which is attached to a trailer using magnets. When he switches on the tractor, it moves forward, pulling the trailer along with it.

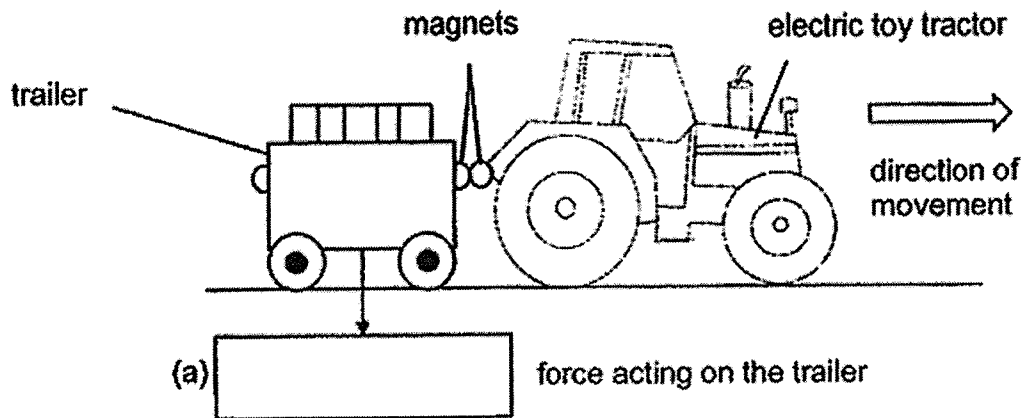

- (a) In the box above, state the force acting downwards on the trailer as it moves along with the tractor. [1]
- (b) State the type of force that exist between the two magnets that are facing each other. [1]

Victor decided to play with his electric toy tractor in a sandpit.

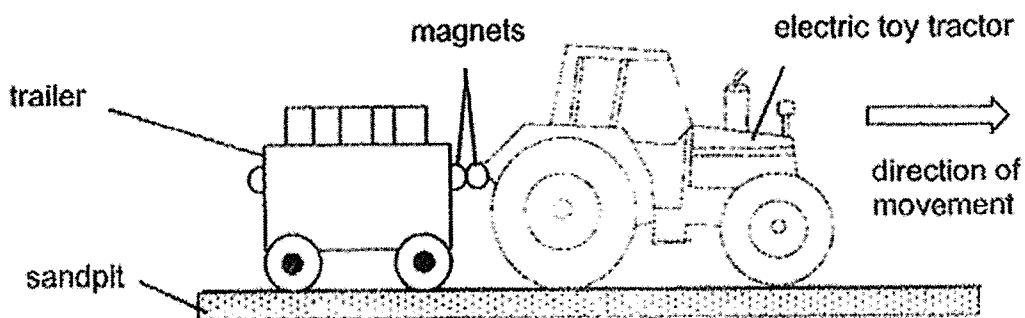

- (c) When he switched on the tractor, it got separated from the trailer and moved on. Explain why the toy tractor was not able to pull the trailer along this time. [2]

37. Mrs Tan took a bottle of sauce from the refrigerator. She noticed that the sauce was frozen when she tilted the bottle of sauce as shown in the diagram below.

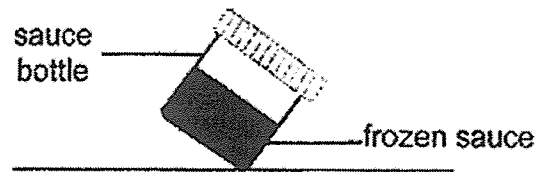

- (a) Give a reason why Mrs Tan knew that the sauce was frozen after tilting the bottle. [1]

When Mrs Tan put the bottle of sauce into a pan of hot water, she observed that the bottle cover is bulging slightly at the top.

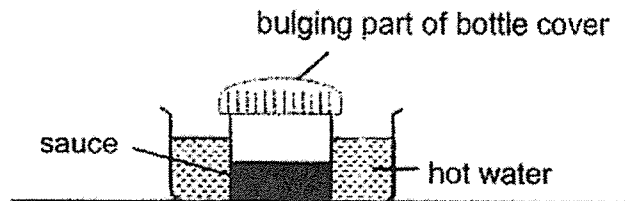

- (b) Explain how the bulging part of the bottle cover was formed. [1]

Mrs Tan removed the bottle of sauce from the hot water and left it on the table for a while.

- (c) Will the bulging part of the bottle cover become smaller, bigger or remain the same? Explain your answer. [1]

38. Mark built a toy as shown below.

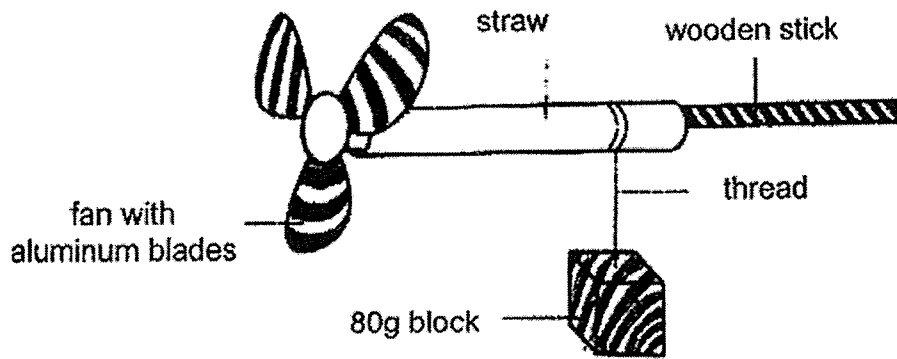

A 80g block was attached to a thread that was wound around a straw. The block was allowed to drop and the fan would spin freely.

- (a) Write down the energy conversion that took place when the 80g block was allowed to drop. [2]

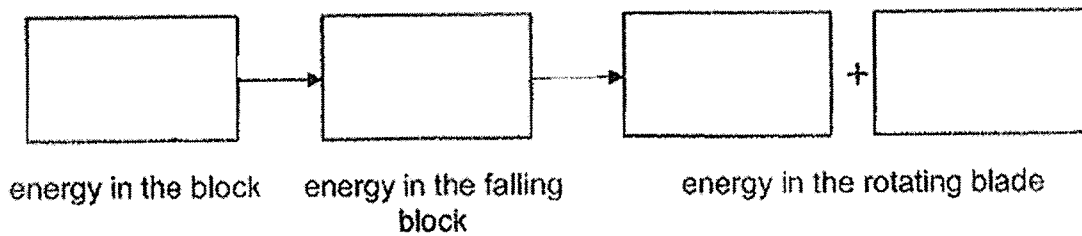

- (b) Suggest a change to the toy to increase the number of spins made by the fan. Explain your suggestion in terms of energy conversion. [2]

Suggestion: _____

Explanation: _____



39. The diagram below shows a simple food dispenser to feed a pet hamster whenever the pet owner is away. The food tray is attached to the metal bar.

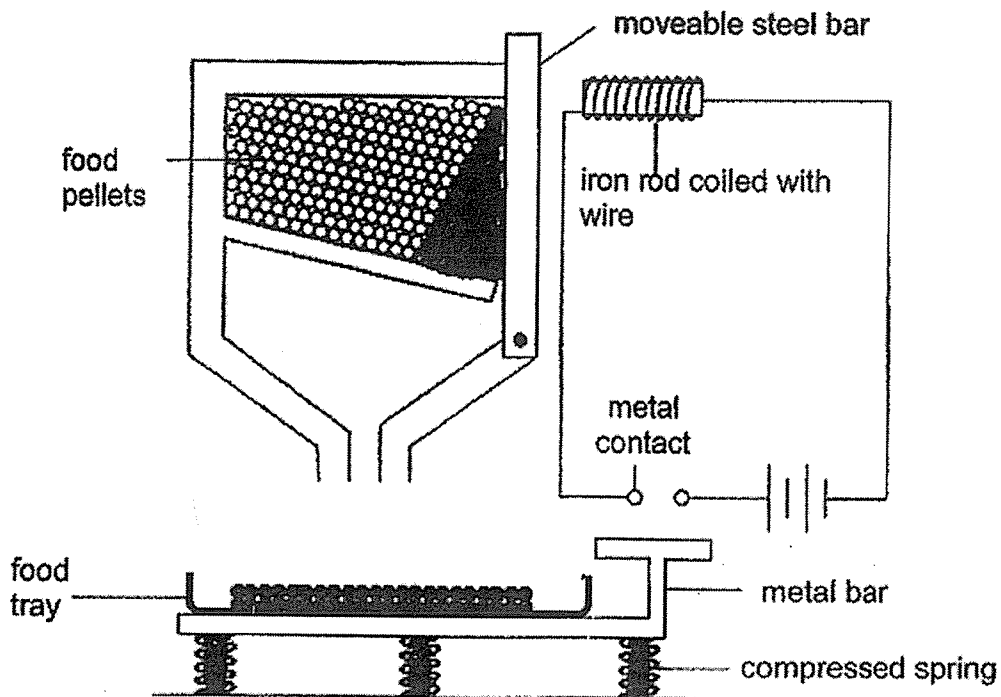

- (a) Explain how the food dispenser works to refill the food pellets when there is little, or no food left in the tray. [2]

- (b) State the energy conversion that takes place when the circuit is closed. [1]

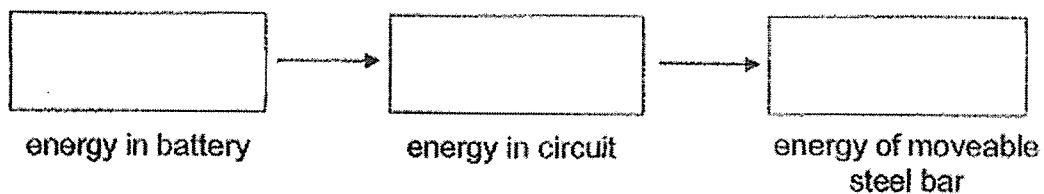

- (c) Suggest a possible change to the spring to refill the food tray even before the food in the tray ran really low. [1]

- (d) By using another object made of material X to replace the moveable steel bar, it was observed that the set-up could not work at all this time. Explain why. [1]

40. Joe conducted an experiment using the containers R, S and T, which are of the same material. He filled the containers with the same volume of water at room temperature and placed them next to a window in the Science room.

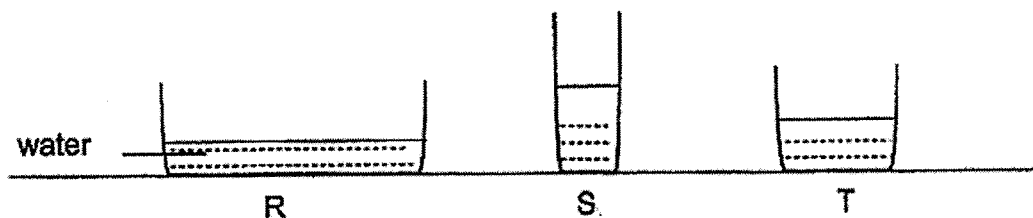

After thirty minutes, he measured the volume of the water left in the containers and recorded his results in the table below.

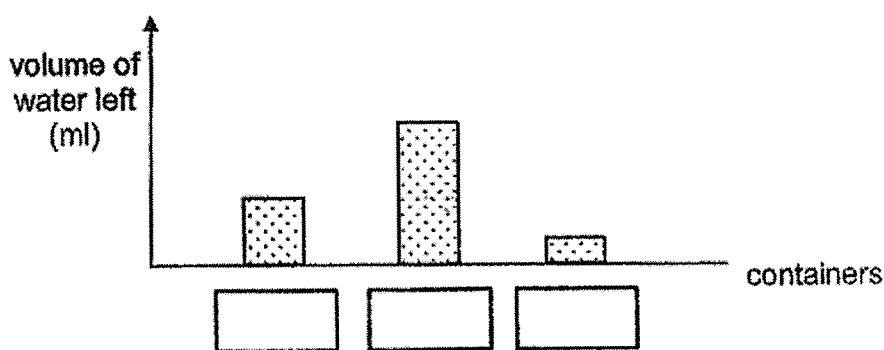

- (a) In the above graph, write the letters R, S and T in the correct boxes, showing the volume of water left in each container after the experiment. [1]

Joe then carried out another experiment to find out how the temperature of water affected the rate of evaporation of water. He filled two identical containers, P and Q, with the same amount of water but at different temperature.

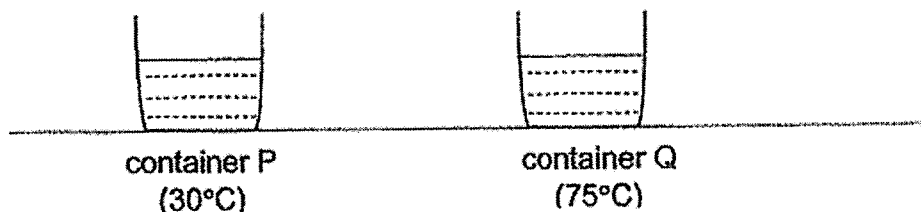

- (b) Joe predicted that the water in container P will decrease faster than in container Q. Do you agree with Joe? Explain your answer. [1]

Harnessing solar power is a cleaner alternative source of energy as compared to burning of natural gas. In Singapore, solar floating panels have been built on reservoirs to trap light energy to generate electricity.

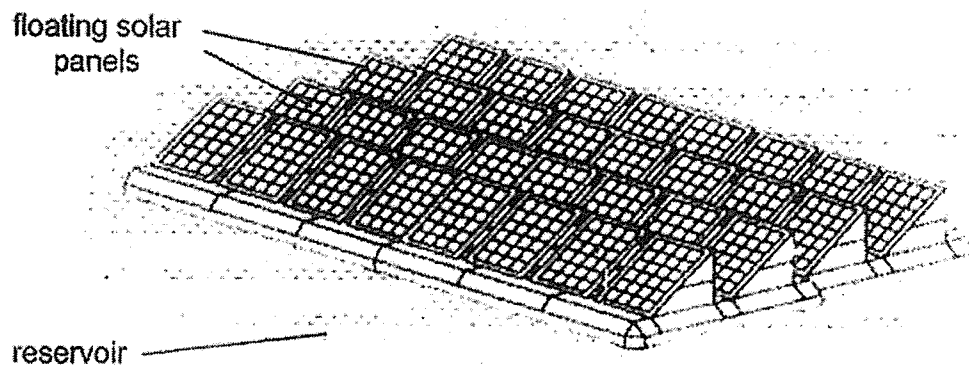

- (c) Researchers noticed that constructing the floating solar panel system in reservoirs has reduced the amount of water lost from the reservoirs. Give a reason for this observation. [1]

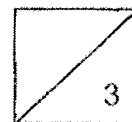

END OF BOOKLET B

SCHOOL : PAYA LEBAR METHODIST GIRLS SCHOOL
LEVEL : PRIMARY 6
SUBJECT : SCIENCE
TERM : 2022 PRELIM

SECTION A

Q1	Q2	Q3	Q4	Q5	Q6	Q7	Q8	Q9	Q10
3	4	4	3	2	2	1	1	1	1
Q11	Q12	Q13	Q14	Q15	Q16	Q17	Q18	Q19	Q20
3	2	2	4	1	3	2	1	1	3
Q21	Q22	Q23	Q24	Q25	Q26	Q27	Q28		
4	2	3	1	1	4	2	4		

29 a)	It needs warmth.
29 b)	At 30 °C, the number of C increased significantly. If there is a large amount of C, the cooked food will spoil more quickly.
29 c)	Priya wanted a fair test where the temperature is the only changed variable.
30 a i)	Linus; The life cycle of a cockroach has three stages while that of a mosquito has 4 stages.
30 a ii)	Netty ; The young of the cockroach resembles the adult while that of the mosquito does not.
30b i)	If there is a layer of oil on the surface of the water, air will be blocked from entering the breathing tube which in the end will cause it to die
30b ii)	If there is no stagnant water, the mosquito will not be able to lay eggs and grow as it needs water to grow
31 a)	Prey: B and D Predator: C and D
31 b)	C will decrease significantly as B is the food source of C and D, where D also feeds on B. Hence, C will lose both its food sources and its population will decrease.
31 c)	A depends on B to get pollinated. Therefore, it is not able to reproduce without B.
31 d)	They do not need to compete for the same food.
32 a)	White moths. White moths could better camouflage themselves against the light-coloured bark and less likely to be spotted and eaten by predators.
32b)	The population of white moths would decrease while the population size of the black moths would increase since the bark of the tree trunks became dark. The black moths can camouflage better and not be spotted easily by predators.
32 c)	Pupa. As the pupa is in a cocoon, it does not eat food and thus will not gain any mass.
33 a)	The worm produced more carbon dioxide in the water. This increases the rate of photosynthesis, so more oxygen is produced.

33 b)	The plant needs light to photosynthesise, if there is no light, it will take in oxygen for respiration. This means that there will not be enough oxygen for both worms and water plants.
33 c)	B. With the same light intensity, B produces more oxygen / gas. The rate of photosynthesis was higher in B than in A.
34 a)	The longer the length of the wingspan, the longer the time taken for the airplane to reach the ground.
34 b)	X as the wingspan is longer and it can travel further away.
34 c)	2. seeds of 2 are smaller than seeds of 1. Seeds of 2 are more likely to be swallowed by animals and passed out as droppings, dispersing them further from the parent plant than seeds of 1.
35 a)	Light will travel until 10cm. B is opaque.
35 b)	Light can pass through easily so A and C are translucent or transparent.
36 a)	Gravitational
36 b)	Magnetic force.
36 c)	The magnetic force could not overcome the frictional force between the wheels and sandpit as the sandpit has more friction between the sandpit and the wheels.
37 a)	The shape did not change.
37 b)	The warm water vapour rose so the bulging part expanded as it gained heat from the warm water vapour.
37 c)	Smaller, as the warm water vapour would have lost heat so the bulging part of the bottle cover would contract as it also loses heat.
38 a)	Gravitational potential \rightarrow kinetic \rightarrow kinetic + heat
38 b)	Make the block heavier; The more gravitational potential energy from the heavier block is converted to more kinetic energy from the heavier block falling. It is then converted to more kinetic and heat energy from the fan.
39 a)	When there is little or no food left in the food tray, the spring expands and the metal bar comes into contact and close the circuit. The iron rod becomes an electromagnet and attract the movable steel bar, causing the food pellets to flow down to the tray.
39 b)	Potential \rightarrow electrical \rightarrow kinetic
39 c)	Make the spring taller
39 d)	X is a non-magnetic material so it could be attracted by the electromagnet.
40 a)	T, S, R
40 b)	Temperature of the water in R is higher, so the water evaporates faster.