

Name : _____ ()

Class : Primary 6 _____

CHIJ ST NICHOLAS GIRLS' SCHOOL

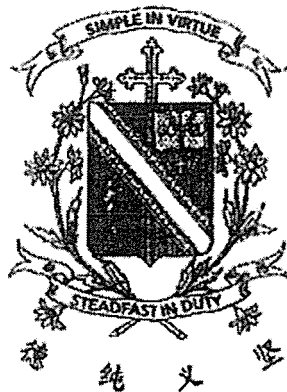

Primary 6

Preliminary Examination

SCIENCE

BOOKLET A

24 August 2022

Total Time for Booklets A and B: 1 hour 45 minutes

**28 questions
56 marks**

**Do not open this booklet until you are told to do so.
Follow all instructions carefully.**

This paper consists of 18 printed pages.

Section A (28 x 2 marks = 56 marks)

For each question from 1 to 28, four options are given. One of them is the correct answer. Make your choice (1, 2, 3 or 4). Shade the correct oval (1, 2, 3 or 4) on the Optical Answer Sheet provided.

1. Which of the following statements about bacteria and fungi is/are false?

- A They can make food on their own.
- B They can breakdown dead materials into simpler substances.
- C They are tiny micro-organisms that can only be seen clearly under a microscope.
- D Some are useful to humans as they can be used to make cheese and bread.

- (1) A only
- (2) A and C only
- (3) B and D only
- (4) B, C and D only

2. The diagram below shows the processes involved in plant reproduction.

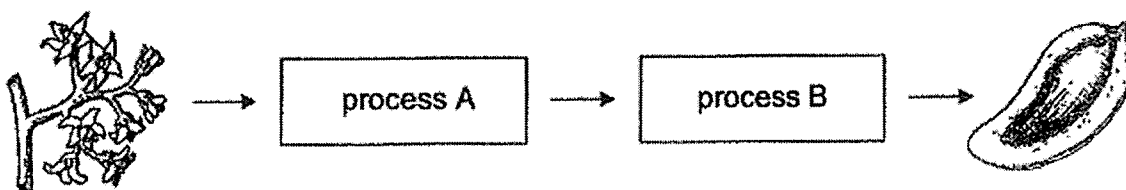

Which of the following correctly identifies processes A and B?

	Process A	Process B
(1)	fertilisation	seed dispersal
(2)	fertilisation	seed germination
(3)	seed germination	pollination
(4)	pollination	fertilisation

3. Study the diagrams below.

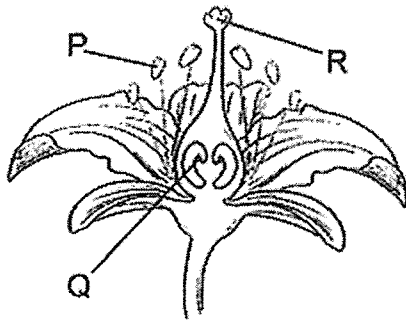

plant reproductive parts

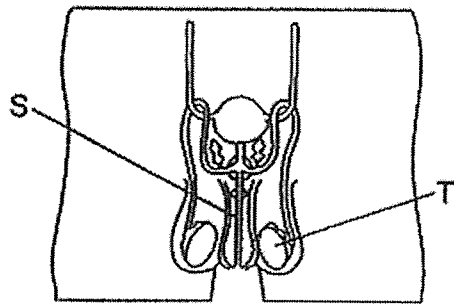

human reproductive parts

Which of these statement(s) is/are correct?

- A Fertilisation happens at part S.
- B Parts P and T produce male reproductive cells.
- C A fertilised egg cell will develop in parts Q and R.

- (1) B only
- (2) A and B only
- (3) A and C only
- (4) B and C only

4. Lynette set up an experiment in a dark room using similar water plants as shown below. After the lamp was switched on, she recorded the number of bubbles given out by the water plants in beakers A, B and C, for five minutes.

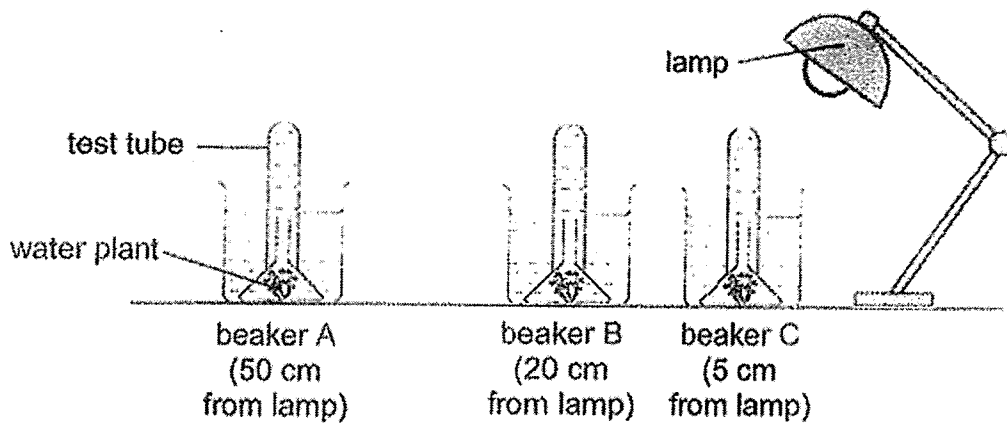

Which of the following best represents the expected results of the experiment?

	Number of bubbles per minute		
	Beaker A	Beaker B	Beaker C
(1)	100	50	0
(2)	0	80	50
(3)	5	70	80
(4)	70	60	100

5. Organism R lives in the coastal region. It produces a glue-like substance to attach itself to rocks so that it does not get washed off easily by strong waves.

Heidi conducted an experiment to find out how the temperature of water affects the effectiveness of the glue-like substance that helps organism R attach to the rocks. The graph below shows her results.

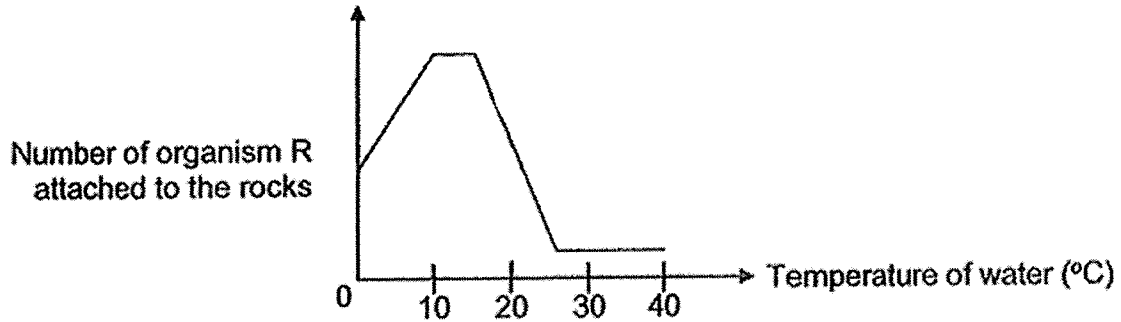

The table below shows the temperature range of four different coastal regions A, B, C and D.

Location	A	B	C	D
Temperature range	21 °C to 26 °C	10 °C to 20 °C	28 °C to 35 °C	1 °C to 9 °C

Which of the locations A, B, C or D has a temperature that is most suitable for rearing organism R?

- (1) A
- (2) B
- (3) C
- (4) D

6. The food web below shows the food relationships between organisms P, Q and R.

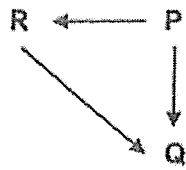

After some time, organism S moved into the habitat and fed on organisms P and Q as shown below.

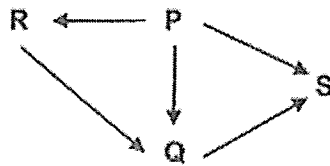

The graph below shows the number of organisms Q over a period of time.

At which point on the graph below did organism S move into the habitat?

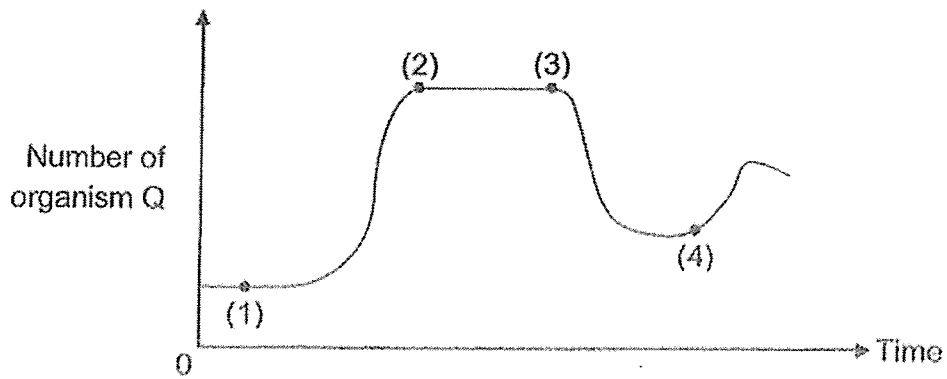

7. The diagram below shows a food web.

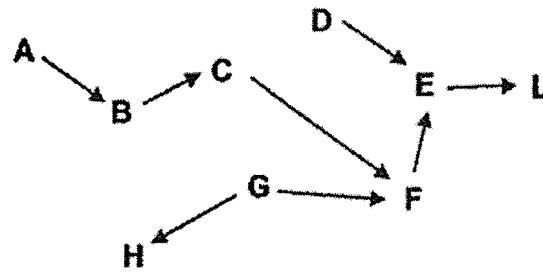

Based on the food web above, which of the following is correct?

	Prey	Both a prey and a predator	Predator
(1)	A, D, G	C, E, F	H, L
(2)	L	B, C, H	A, D, L
(3)	A, H, L	D	B
(4)	B	C, E, F	L

8. The diagram below shows a plant with an adaptation labelled P.

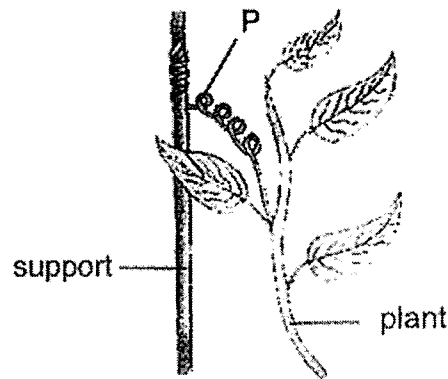

Which one of the following statements about the adaptation above is correct?

- (1) Part P helps the plant to make food.
- (2) Part P helps the plant to attract pollinators.
- (3) Part P helps the plant to reach for more sunlight.
- (4) Part P helps the plant to transport food and water to all parts of the plant.

9. Study the diagram below. Organism A resembles organism B which is aggressive and hunts in groups. Predators stay away from organism A as they may mistake them of organisms B. Organism A smells and behaves like organism B. Organism A feeds on the young of organism B.



organism A



organism B

Which of the following statements is true for organisms A and B?

- A Both organisms A and B hunt for the same type of food.
 - B Organism B can benefit from this relationship with organism A.
 - C Organism A resembles organism B for protection from predators.
 - D Behaving like organism B allows organism A to get food from organism B undetected.
- (1) A and B only
(2) C and D only
(3) A, C and D only
(4) All of the above

10. Which of the following is not an impact of deforestation by cutting trees?

- A Acid rain
 - B Soil erosion
 - C Loss of habitat
 - D Smoke and haze
 - E Increased levels of carbon dioxide
- (1) A and D only
(2) B and C only
(3) A, D and E only
(4) B, C and E only

11. The diagram below shows animal farms located next to a river. Animal waste from the farms flow into the river.

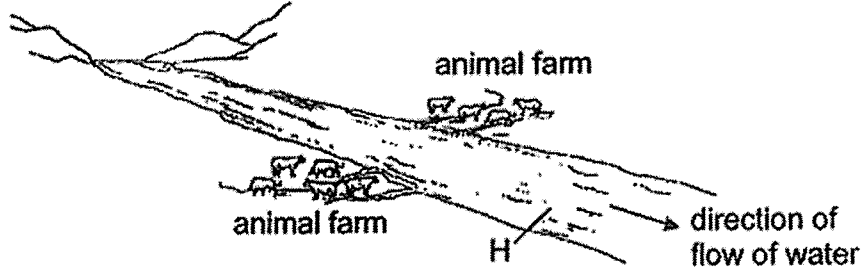

After some time, the plants living deep in the river after Point H died.
Which graph best represents the effect of animal waste entering the river at H?

(1)

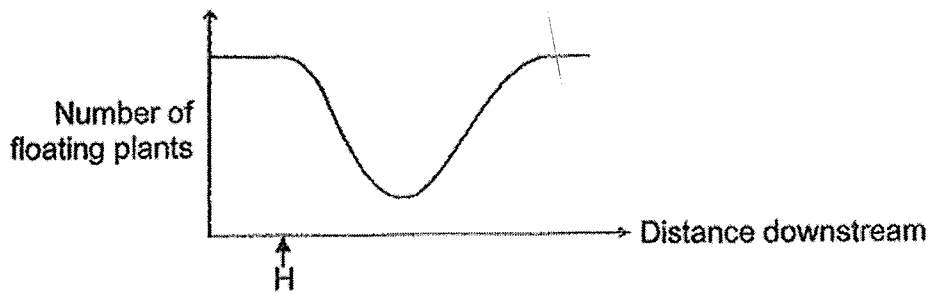

(2)

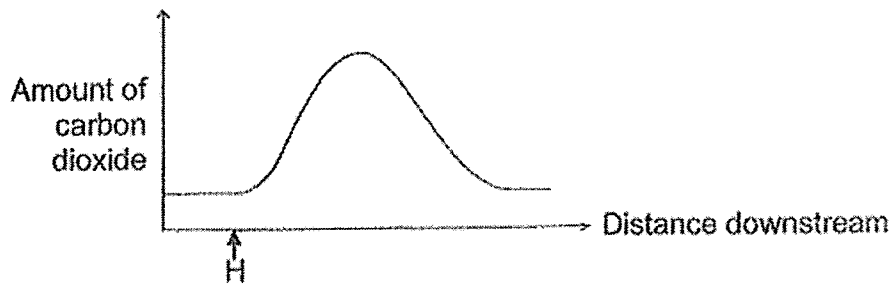

(3)

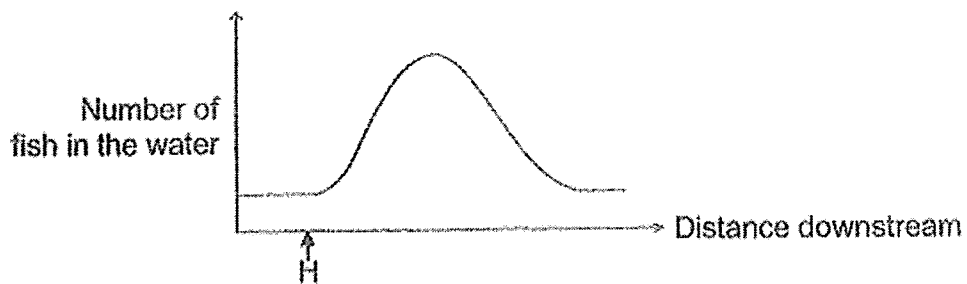

(4)

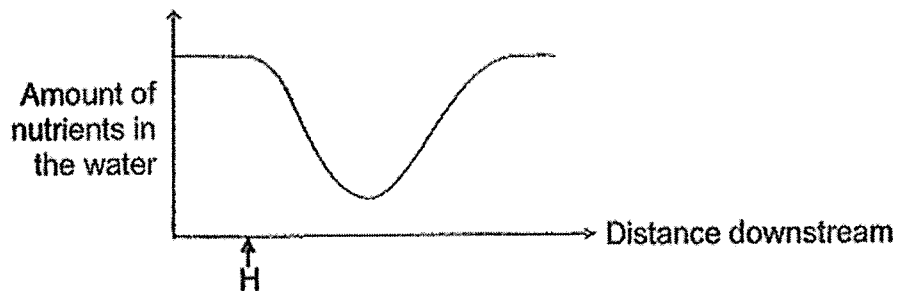

12. Study the chart below.

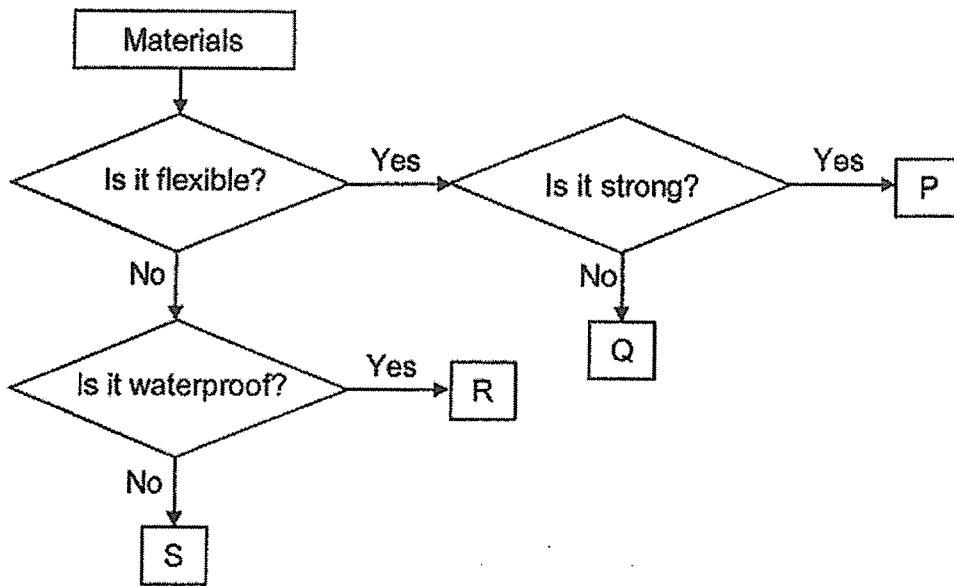

Which of the materials P, Q, R or S is the most suitable to make parts A and B of the bicycle shown below?

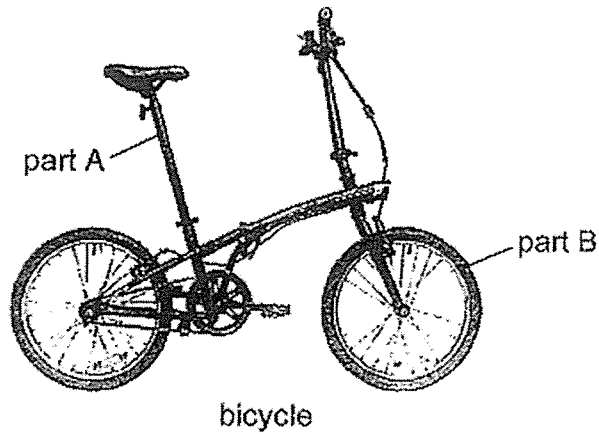

	Part A	Part B
(1)	S	Q
(2)	R	P
(3)	Q	R
(4)	P	S

13. Study the classification table below.

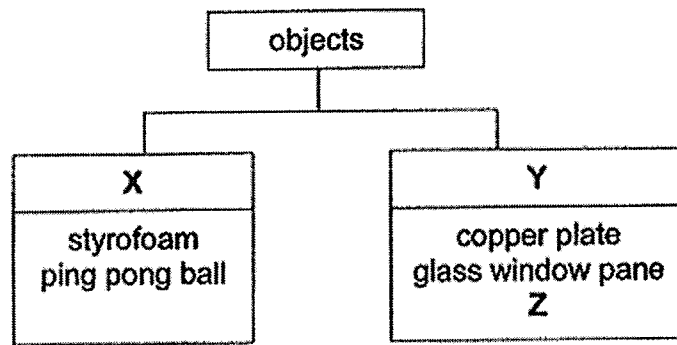

Which of the following is possible?

	X	Y	Z
(1)	allow light to pass through	do not allow light to pass through	cloth
(2)	electrical insulators	electrical conductors	iron rod
(3)	break easily	do not break easily	wooden plank
(4)	float on water	sink in water	iron key

14. Jane conducted an experiment using three magnets hung from a wooden pole.

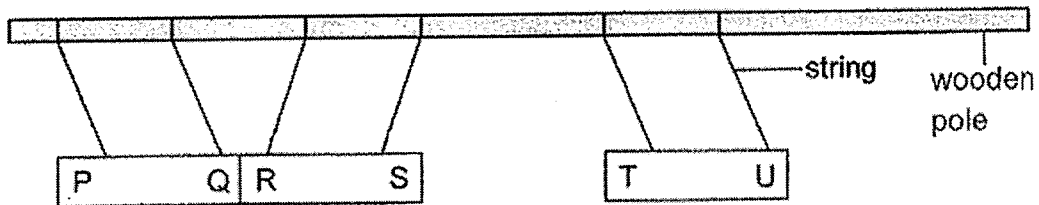

She made some predictions when some of the poles of the magnets were brought close together. She recorded her predictions in the table below.

Prediction	Poles brought close together	Result
A	P and S	attraction
B	P and T	repulsion
C	Q and S	repulsion
D	R and U	attraction

Which of her prediction(s) is/are most likely correct?

- (1) A only
- (2) A and C only
- (3) B and D only
- (4) B, C and D only

15. At the start of an experiment, the mass of a sealed plastic bag of air was measured using an electronic balance as shown below. The bag was then placed in the freezer for six hours, after which, it was taken out and its mass was measured again.

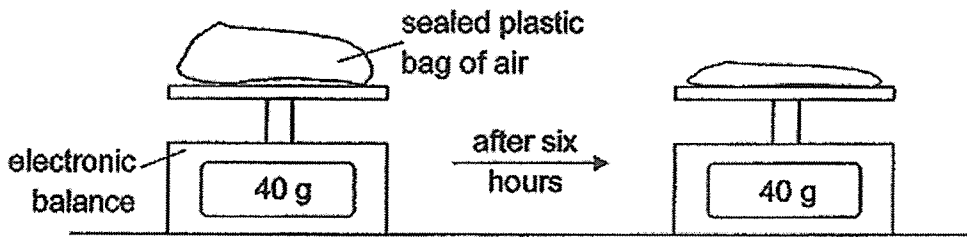

Based on the above experiment, which of the following is correct?

Observations after six hours		Explanation
Mass of air in the bag	Volume of air in the bag	
(1) increase	constant	Some air in the bag escaped into the freezer.
(2) decrease	constant	Some air in the freezer entered the bag.
(3) constant	increase	Air in the bag expanded.
(4) constant	decrease	Air in the bag contracted.

16. The diagram below shows a sealed container holding 400 cm^3 of honey and 600 cm^3 of air. 200 cm^3 of honey was then removed and 100 cm^3 of air was pumped into the container.

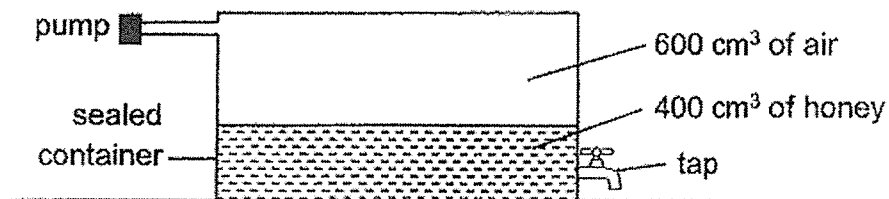

What is the final volume of air in the container?

- (1) 200 cm^3
 (2) 600 cm^3
 (3) 700 cm^3
 (4) 800 cm^3

17. The diagram shows a beaker containing equal amounts of two substances E and F.

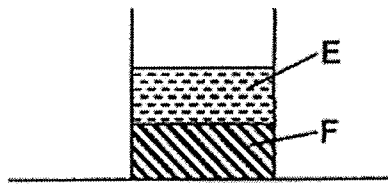

The same beaker was then placed on a wooden ramp and the following results were observed.

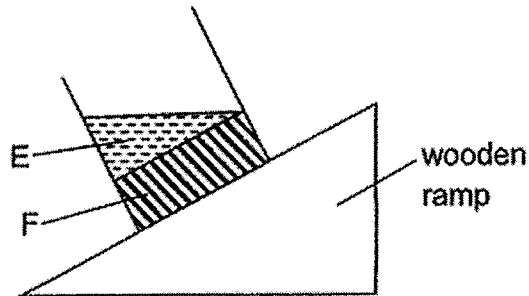

Based on the above results, which of these statements are correct?

- A Both E and F occupy space.
- B Both E and F have no definite volume.
- C E has no definite shape but F has a definite shape.
- D E can be compressed but F cannot be compressed.

- (1) A and C only
- (2) B and D only
- (3) A, C and D only
- (4) B, C and D only

18. In the diagram below, Henry is able to see the cat when the ceiling light remains switched on.

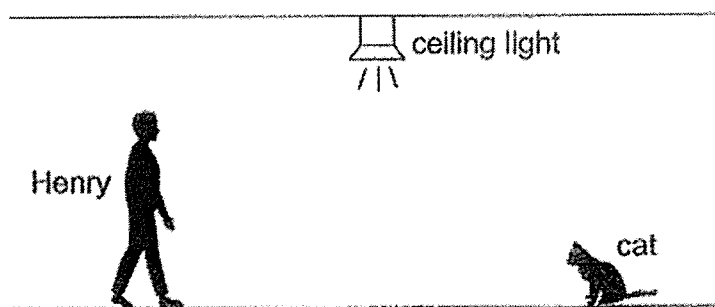

Which of the following correctly shows the path of light that enables Henry to see the cat clearly?

- (1) ceiling light → Henry's eyes → cat
- (2) ceiling light → cat → Henry's eyes
- (3) Henry's eyes → ceiling light → cat
- (4) Henry's eyes → cat → ceiling light

19. Ali collected wooden objects E, F and G for an experiment. The dimensions and shapes of the objects from the front-view are shown below.

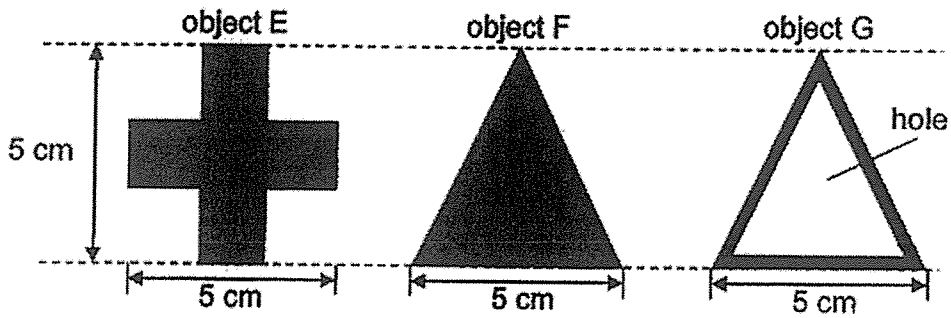

The objects were placed in a straight line at positions A, B and C.

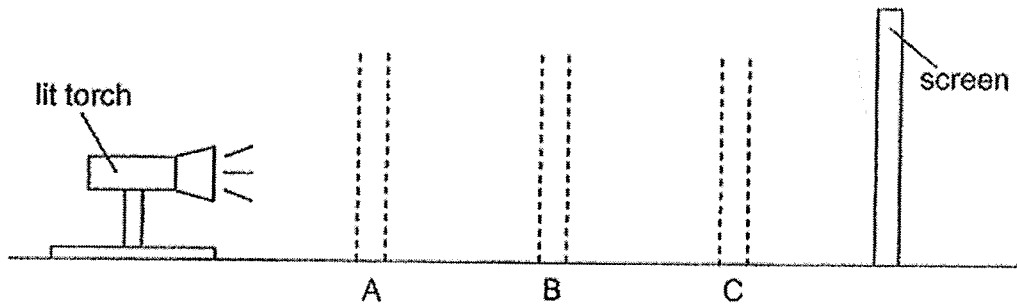

The following shadow was seen on the screen.

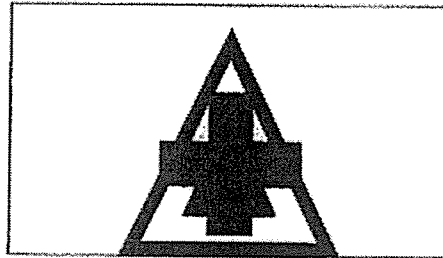

Which of the following shows the correct position of the objects that will result in the shadow shown above?

	Position A	Position B	Position C
(1)	E	F	G
(2)	E	G	F
(3)	G	E	F
(4)	G	F	E

20. Lily conducted an experiment using the set-ups below. Equal amounts of boiled water were poured into the container. The containers were then placed into the freezer. Both containers had the same temperature at the start of the experiment.

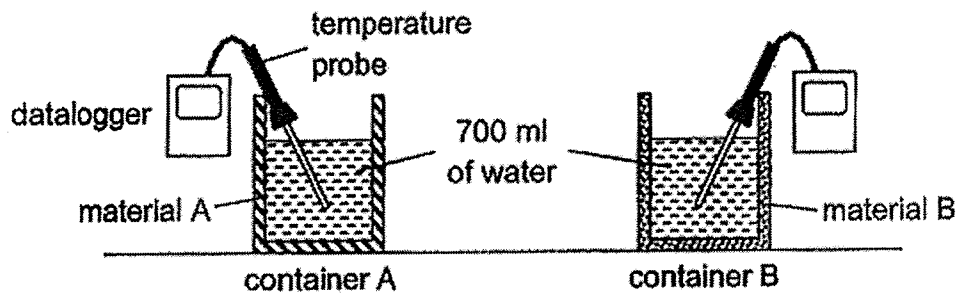

Lily recorded the changes in temperature of the water in both containers as they reach 0 °C in the graph below.

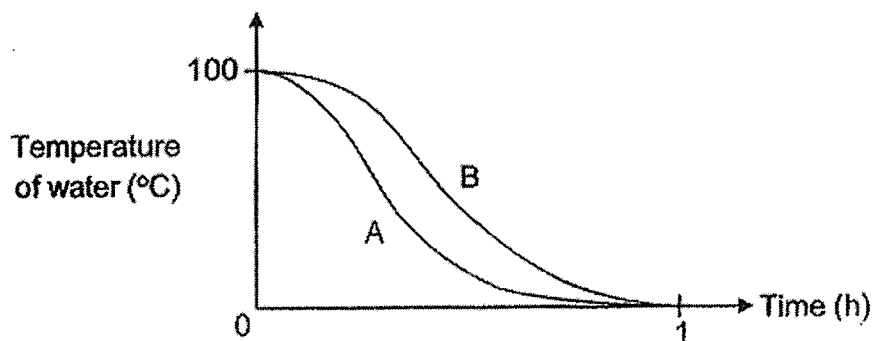

Lily wanted to bring along some warm snacks and cold drinks for a picnic. She wanted to ensure the snacks remain warm and drinks remain cold for the longest duration possible. Which material A or B should be used for making the containers for her snacks and drinks?

	Material for holding warm snacks	Material for holding cold drinks
(1)	A	A
(2)	A	B
(3)	B	A
(4)	B	B

21. The diagram below shows two flasks connected by a glass tube containing a drop of ink.

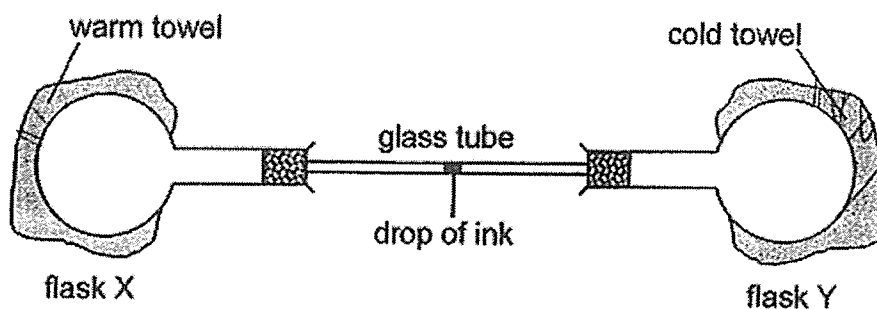

Which of the following shows the correct observation after 5 minutes?

	Movement of drop of ink	Direction of heat transfer
(1)	towards flask Y	from air in flask Y to cold towel
(2)	towards flask Y	from air in flask X to warm towel
(3)	towards flask X	from warm towel to air in flask X
(4)	towards flask X	from cold towel to air in flask Y

22. The table below shows the states of four different substances P, Q, R and S at different temperatures.

Substance	State of matter of the substance		
	At 2 °C	At 60 °C	At 100 °C
P	solid	solid	solid
Q	liquid	liquid	gas
R	solid	liquid	liquid
S	liquid	gas	gas

Which substance has the highest boiling point?

- (1) P
 (2) Q
 (3) R
 (4) S

23. The diagrams below show four containers made of the same material. Different volumes of tap water at 50 °C were then poured into each container at the same time. The containers were later placed in the Science lab.

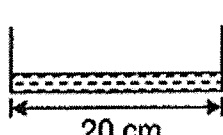
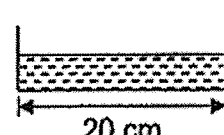
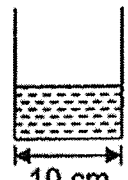
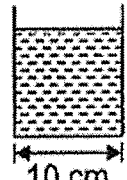
500 ml of tap water 	1000 ml of tap water 	500 ml of tap water 	1000 ml of tap water 
set-up A	set-up B	set-up C	set-up D

Based on the above set-ups, which of the following statements is false?

- (1) Water in set-ups A and B have the same rate of evaporation.
- (2) Water in set-ups C and D have the same rate of evaporation.
- (3) Water in set-up B has a lower rate of evaporation than water in set-up D.
- (4) Water in set-up A has a greater rate of evaporation than water in set-up C.

24. Each of the circuits below contains a steel rod, a rubber rod and a copper rod.

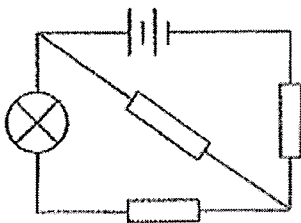

circuit A

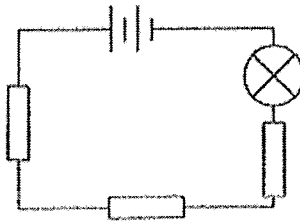

circuit B

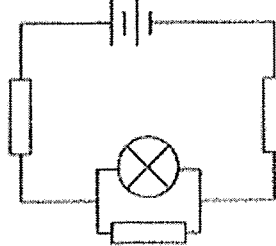

circuit C

In which of the above circuit(s) will it be possible for the bulb to light up?

- (1) A only
- (2) B only
- (3) A and C only
- (4) A and B only

25. The diagram below shows a toy. When the roller is turned, the rubber band attached to it becomes twisted. When Ronald released the toy, it moved along the table.

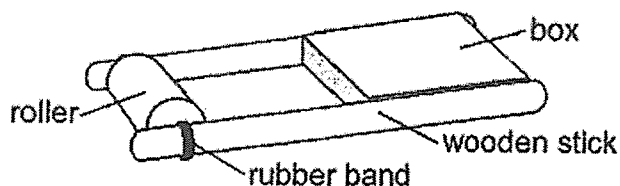

Ronald conducted an experiment using the toy and his results are shown in the table below.

Number of turns of the roller	Distance moved by the toy (cm)
3	10
6	19
9	28
12	39

Based on the results of his experiment, what can Ronald conclude?

- (1) The greater the number of turns, the greater the distance moved by the toy.
- (2) Chemical potential energy was converted to elastic potential energy of the toy.
- (3) When the number of turns of the roller decreased, the distance moved increased.
- (4) Elastic potential energy of the roller was converted to kinetic energy of the toy to cause it to move.

26. The diagram below shows a structure which can be built at sea to generate electricity.

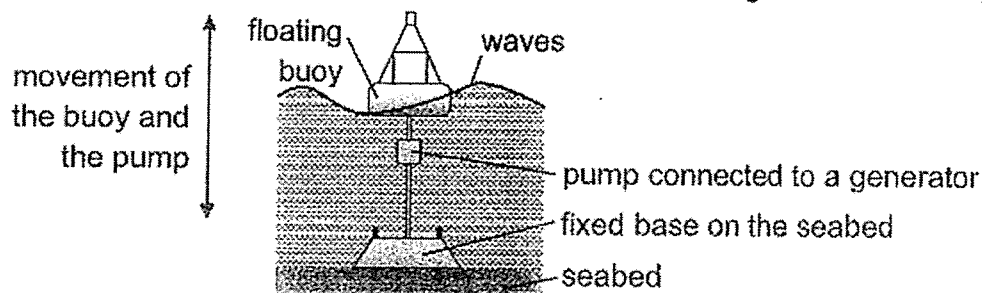

As the buoy moves up and down with the waves, the pump connected to it moves as well. The movement of the pump causes the generator to rotate and generate electricity.

Based on the information given, which of the following are correct?

- A Wave energy is a non-renewable source of energy.
 - B The amount of energy generated is not constant all the time.
 - C Kinetic energy of the waves is converted to electrical energy of the pump.
 - D This method of generating electricity does not release any harmful gases.
- (1) A and C only
 - (2) B and D only
 - (3) A, B and D only
 - (4) B, C and D only

27. Which of the following statements about mass and weight is true?

- (1) Weight is the amount of matter in an object.
- (2) Mass is the amount of force acting on an object.
- (3) Mass can be measured using a weighing balance.
- (4) Weight of an object remains unchanged on Earth and on the Moon.

28. Martha conducted an experiment using a 3 cm spring. She hung a 10 g mass on it and measured the length of the spring. She repeated her experiment with masses of 20 g, 30 g and 40 g and recorded her results in the table shown below.

Mass of load hung (g)	10	20	30	40
Length of spring (cm)	5	7	9	11

She then plotted her results on a graph.

Which one of the following graphs best represents Martha's results?

(1)

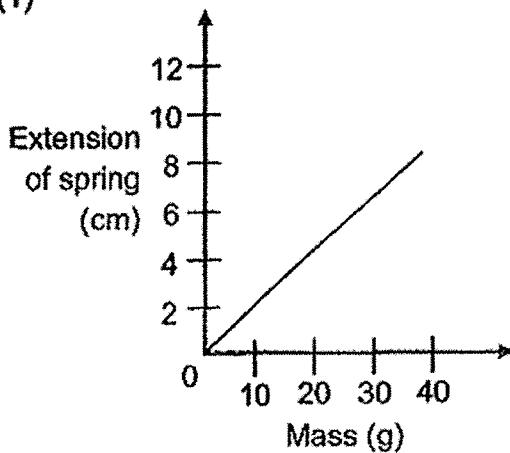

(2)

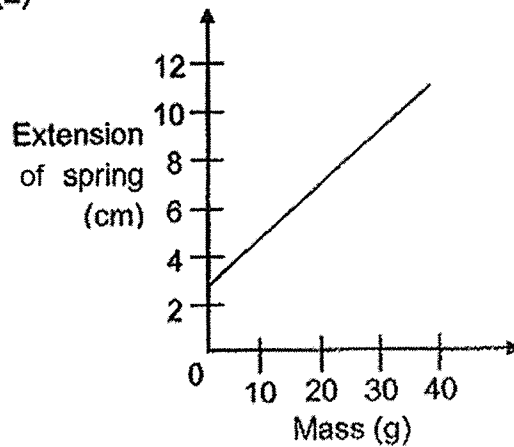

(3)

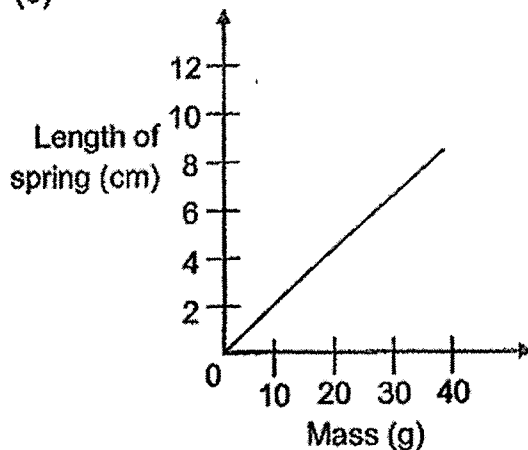

(4)

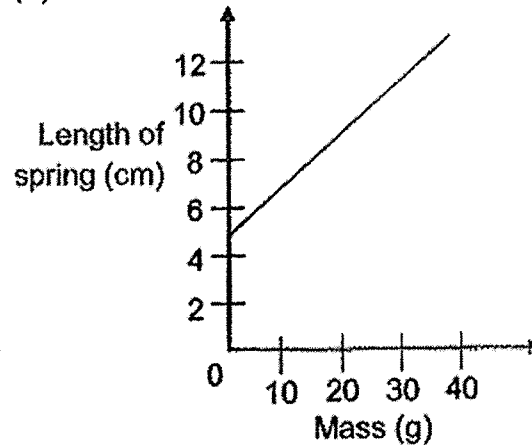

END OF BOOKLET A

Name : _____ (

Class : Primary 6 _____

CHIJ ST NICHOLAS GIRLS' SCHOOL

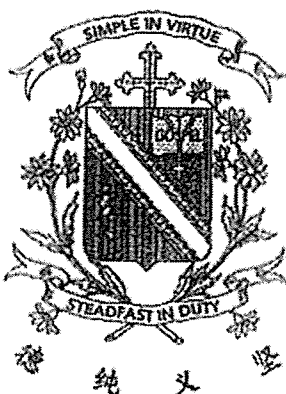

Primary 6

Preliminary Examination

SCIENCE

BOOKLET B

24 August 2022

Total Time for Booklets A and B: 1 hour 45 minutes

13 questions
44 marks

Do not open this booklet until you are told to do so.
Follow all instructions carefully.
Answer all questions.

This booklet consists of 16 printed pages.

Booklet A	56
Booklet B	44
Total	100

Parent's Signature/Date

Section B (44 marks)

For questions 29 to 41, write your answers in this booklet. The number of marks available is shown in the brackets at the end of each question or part question.

29. Mary conducted an experiment in a garden using the set-ups below.

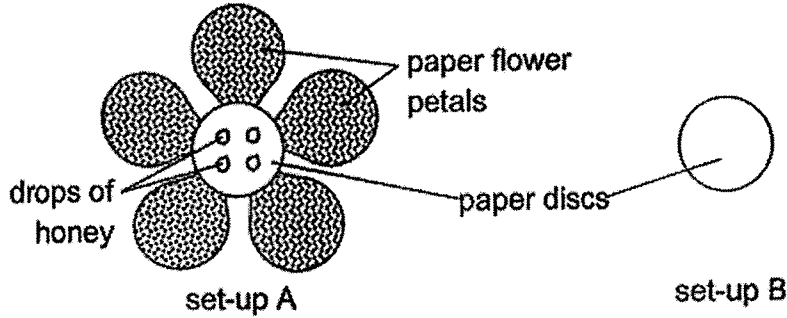

She then released some bees to both set-ups. After a few minutes, she recorded the number of bees that had landed on each paper disc.

(a) Her teacher said that the experiment was unfair. Explain why. [1]

(b) Suggest a change she can make to one of the set-up(s) above to ensure a fair experiment. [1]

Mary found two flowers R and S in the garden as shown below.

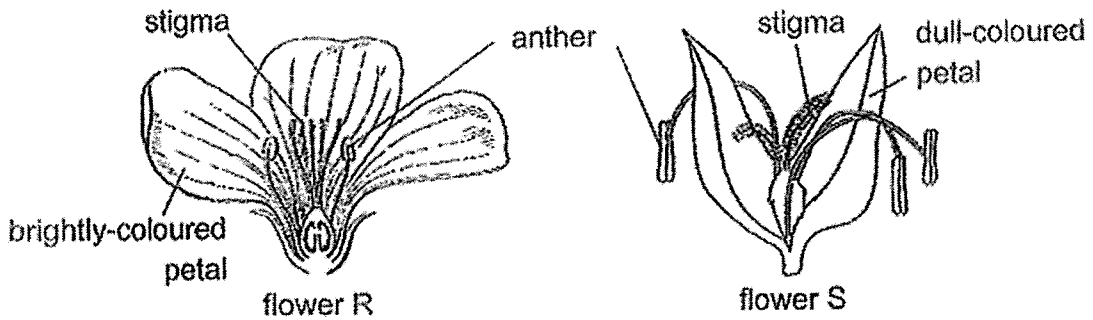

(c) Which flower, R or S, is most likely to be pollinated by wind? Explain your answer. [2]



30. Plants use light energy to make food.

- (a) State the part of a plant cell that allows it to make food. [1]

Ken set up an experiment as shown below. He wanted to find out if carbon dioxide is needed for photosynthesis. He first placed the set-up in a dark room for a day before putting it under bright sunlight for 6 hours. He then tested a leaf of the plant for starch.

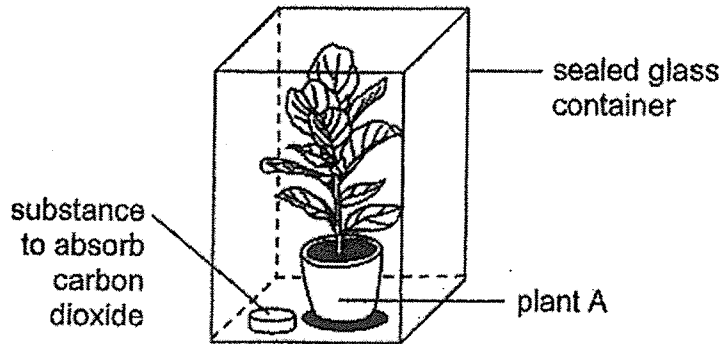

- (b) Give a reason why Ken first placed the set-up in a dark room. [1]

- (c) Suggest a control set-up that Ken can use for his experiment. [1]

- (d) Other than the amount of light and carbon dioxide, state one other factor that would affect the rate of photosynthesis in plant A. [1]



31. Jia Ling observed that plants Q and R can be found in the same pond.

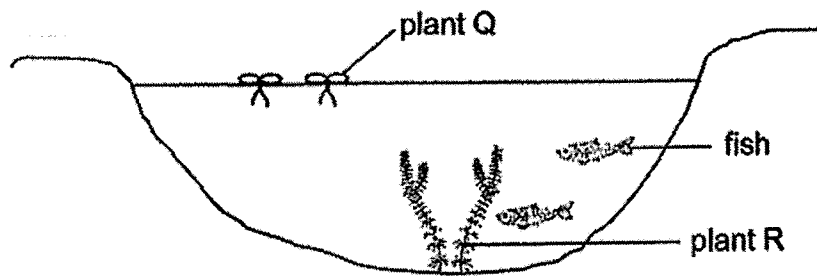

She wanted to find out if an increase in the population of plant Q would affect the population of Plant R. She set up an experiment as shown below. The set-ups were left under bright light for a week.

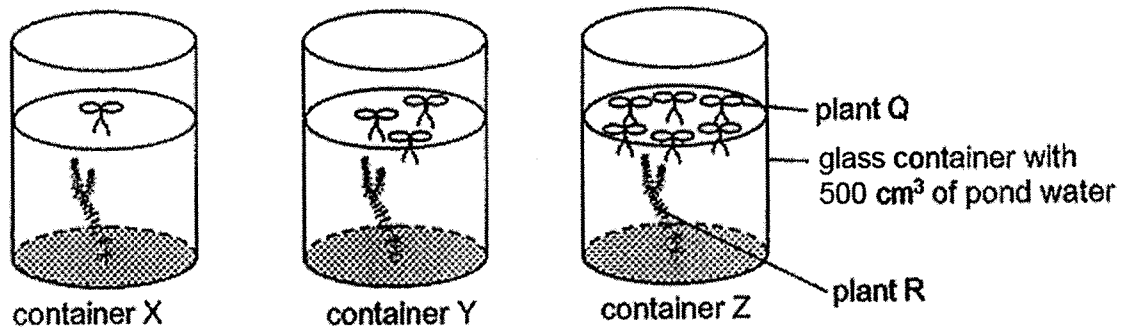

(a) Suggest a possible hypothesis for her experiment. [1]

(b) Her mother said that her experimental set-ups do not allow her to investigate her aim. Suggest one change Jia Ling can make to her experimental set-ups to allow her to investigate her aim. [1]

(c) Other than repeating her experiment a few more times, what can Jia Ling do to increase the reliability of her results? [1]

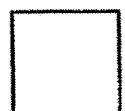

32. Study the food chain shown below.

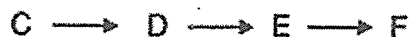

(a) What does a food chain show?

[1]

The bar graph below shows the amount of energy that each organism D, E and F, received in the food chain above.



(b) Based on the graph above, give a reason why the amount of energy received by each organism decreases.

[1]



33. The diagram below shows organisms A and B. The two organisms depend on each other for survival.

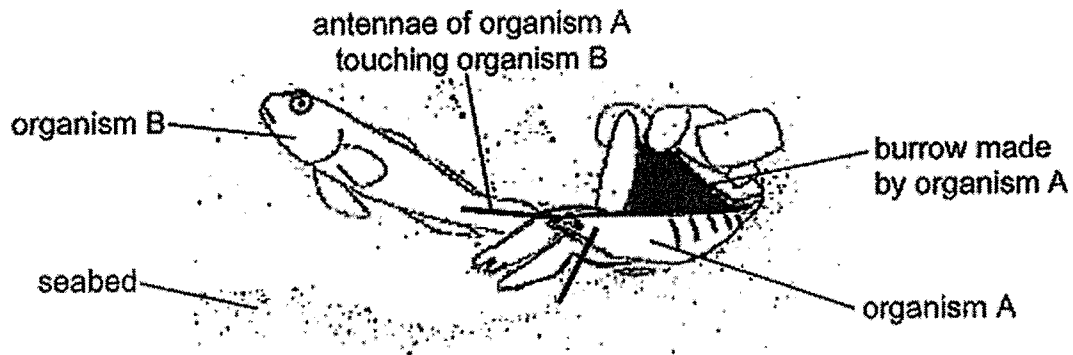

The table below shows some characteristics of organism A.

Characteristics of organism A
<ul style="list-style-type: none"> • has poor vision • has strong claws, with one slightly bigger than the other • can dig and maintain a burrow for hiding from predators • can shoot out fast and loud bubbles from its claws to stun or kill prey

- (a) Based on the information given above, state a behavioural adaptation that allows organism A to survive in its environment. [1]

The table below shows the characteristics of organism B.

Characteristics of organism B
<ul style="list-style-type: none"> • has very good vision • uses the burrow for mating • usually found guarding the burrow • hides in burrow when it senses danger • can filter out sand from the food it eats using its gills

- (b) Based on the information given above, state a structural adaptation that allows organism B to survive in its environment. [1]

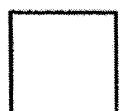

- (c) State one way in which organism B could benefit from its relationship with organism A. [1]

- (d) Organism A usually ensures that its antennae are touching the tail of organism B so that it can track when organism B hides inside the burrow. Explain how this might benefit organism A. [2]



34. The diagram below shows a new factory located next to a forest.

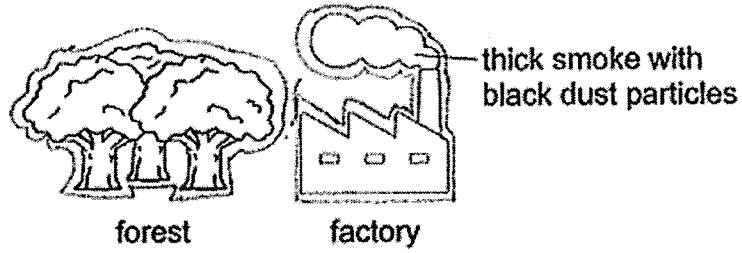

- (a) The bark of the trees in the forest was light in colour. After several years, they became darker in colour. Based on the diagram above, suggest a reason for this observation. [1]

Moths X and Y shown below frequently rests on the trunks of trees in the forest.

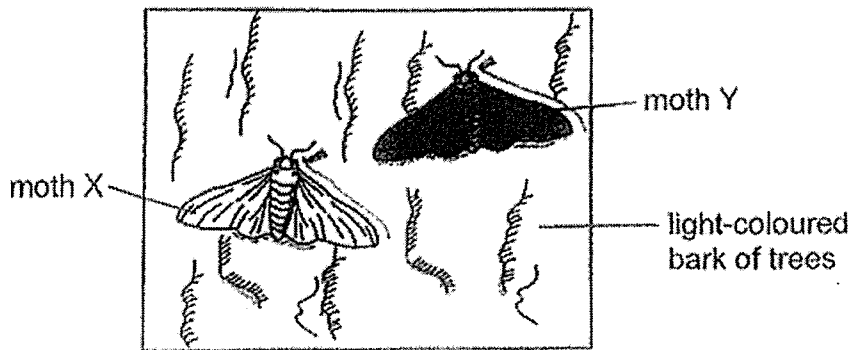

The graph below shows how the population of moths X and Y has changed over a few years. Point F indicates the time when the factory started its operations.

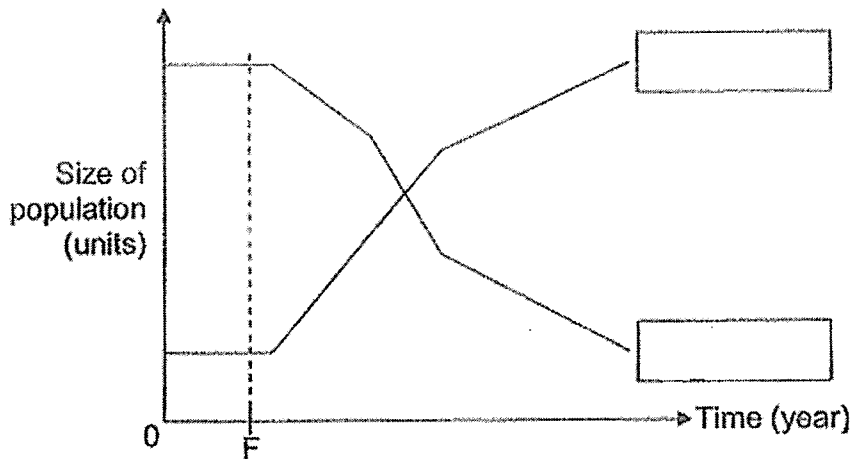

- (b) In the boxes provided above, write 'Moth X' or 'Moth Y' to label the graphs to show how the population of each type of moth has changed over the years. [1]

(c) Explain your answer for moth Y in part (b).

[1]

35. Rashid conducted an experiment in a dark room using the set-up below. When no material was placed at position X, the light sensor detected a reading of 150 units. Material E was then placed at position X and the reading was taken.

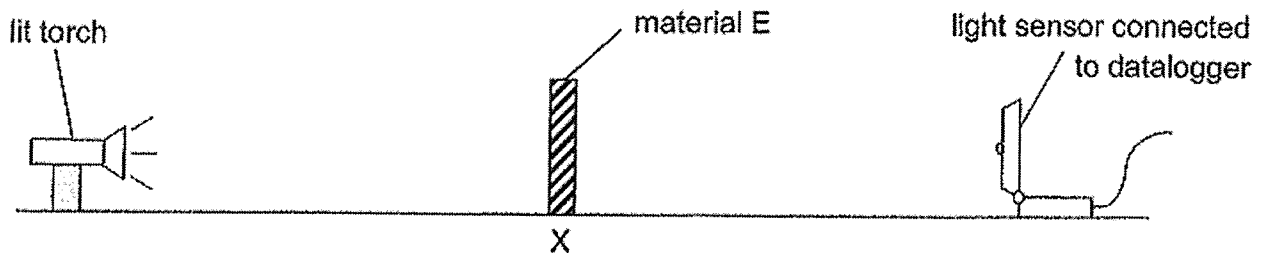

He later repeated the experiment using materials F and G and recorded his results in the table below.

Material	Amount of light detected (units)
E	100
F	5
G	46

- (a) Based on the results, arrange materials E, F and G according to their transparency.

[1]

allows least amount of light to pass through	→	allows most amount of light to pass through

- (b) Medicine P spoils easily when exposed to bright light.

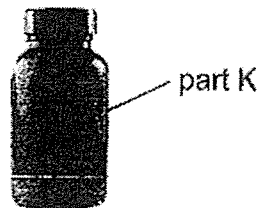

bottle containing medicine P

Which material E, F or G should be used to make part K of the bottle above? Explain your answer.

[2]



36. The diagram below shows how a barrier is used at car parks.

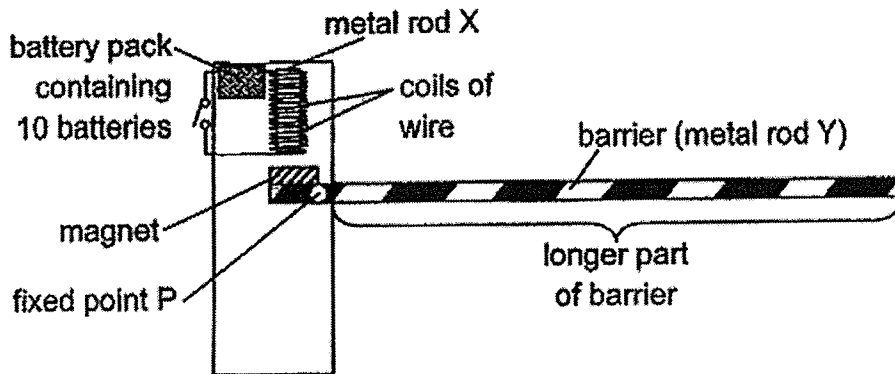

(a) Name a metal that is suitable for making metal rod X. [1]

When the switch was closed, it was observed that the barrier rotates about point P causing its longer part to move upwards to allow cars to pass through.

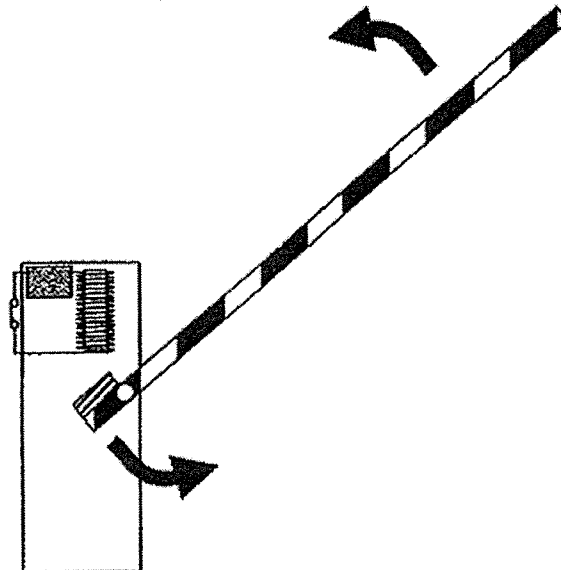

(b) State a property of magnets that allows the above observation to happen. [1]

(c) Other than changing the number of batteries in the battery pack, suggest one other way to make the barrier move up faster when the switch is closed. [1]

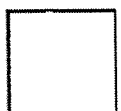

37. Dan poured an equal volume of cold water into two glasses X and Y. Glass X only has a single-layered glass while glass Y has a double-layered glass with a layer of air trapped as shown below.

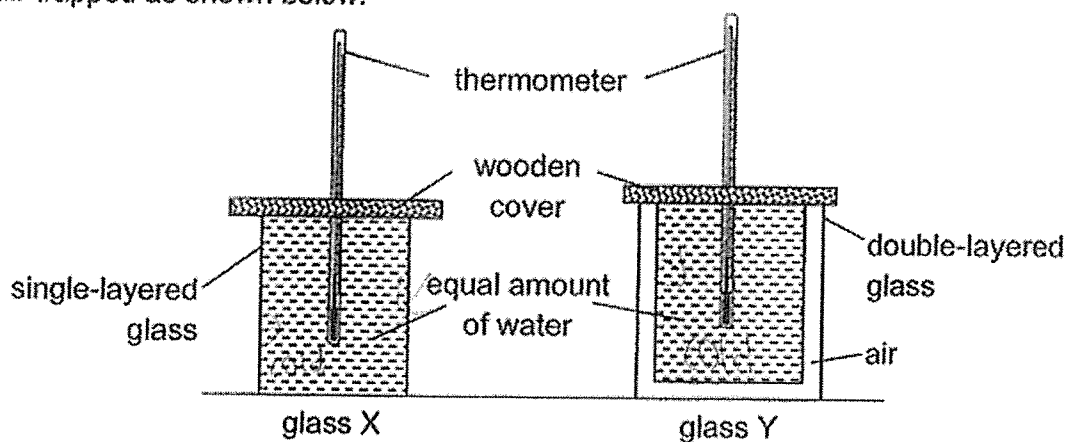

- (a) In which glass, X or Y, will the temperature of water be lower after 45 minutes? Explain your answer. [2]

- (b) State one variable that must be kept constant for the experiment to be fair. [1]

Dan wanted to buy a winter jacket.

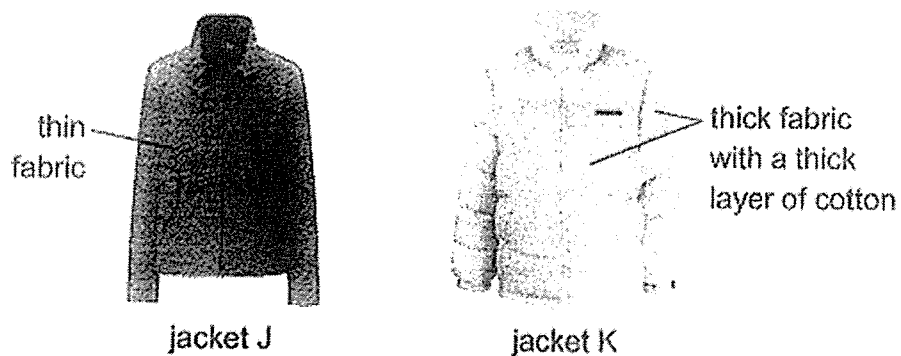

- (c) Which jacket, J or K, should he choose if he wants to keep himself warm for a longer period of time? Explain your answer. [1]



38. Raju placed some crushed ice on a metal tray. He then left the tray out in the open. After a few seconds, he noticed some white mist appeared above the crushed ice.

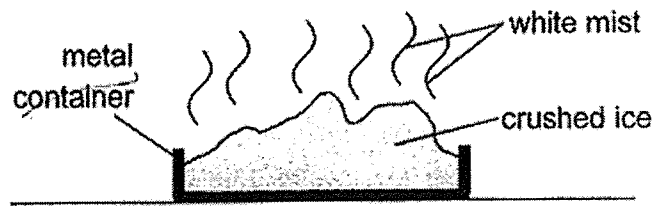

- (a) Explain how the white mist was formed.

[2]

Raju conducted an experiment using the set-ups below. He placed equal amounts of crushed ice in both funnels. He then added different amounts of salt K to the crushed ice in both set-ups.

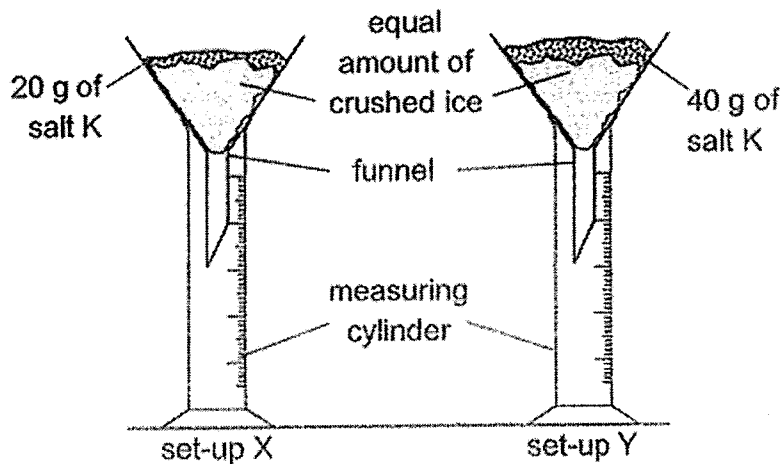

The crushed ice in both set-ups started to melt. He recorded the amount of water collected in each cylinder for a duration of 10 minutes. The results are shown in the graph below.

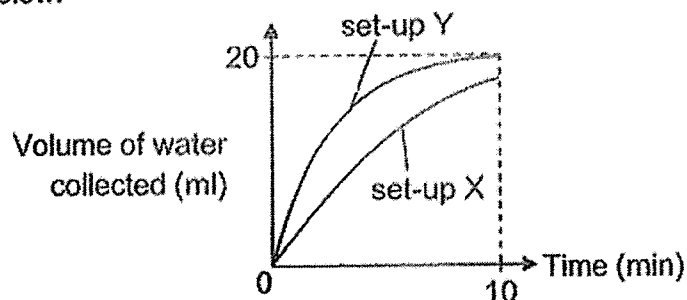

- (b) State a possible aim for his experiment.

[1]

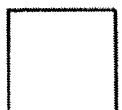

- (c) Based on the graph, what is the relationship between the amount of salt K added to the crushed ice and the volume of water collected? [1]

Raju conducted another experiment using another set of similar set-ups. He used equal amounts of crushed ice for both set-ups.

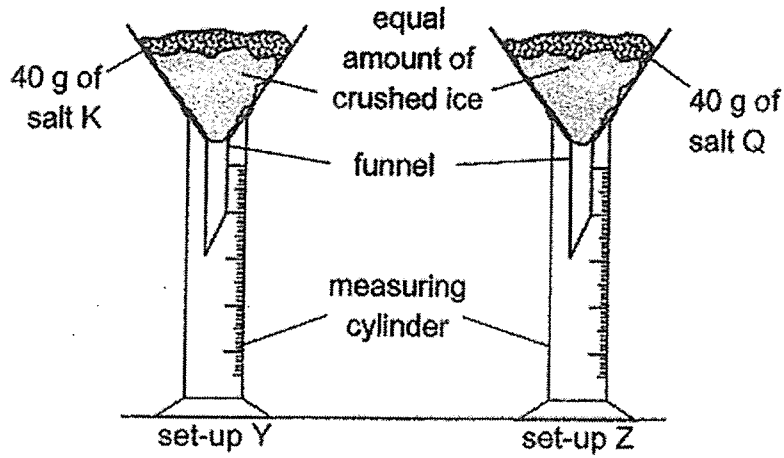

- (d) Based on the above set-ups, state the changed variable for this experiment. [1]



39. Diagram 1 shows the front-view of Ken's toy police car. He sets up an electric circuit in the toy using bulbs P and Q, a siren S and some batteries as shown in diagram 2. All the circuit components are in good working condition.

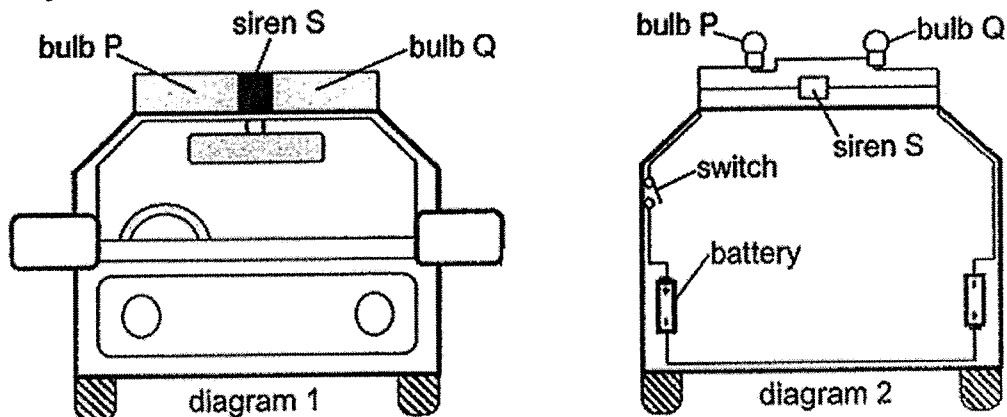

- (a) Based on diagram 2, will the bulbs and siren work when the switch is closed? Explain your answer. [1]

- (b) State the type of arrangement of the bulbs in the electric circuit in diagram 2. [1]

Ken's mother suggested that he connect the bulbs in a different arrangement to make both bulbs brighter when the switch is closed.

- (c) In diagram below, complete the electric circuit to show how his mother's suggestion can be done. [1]

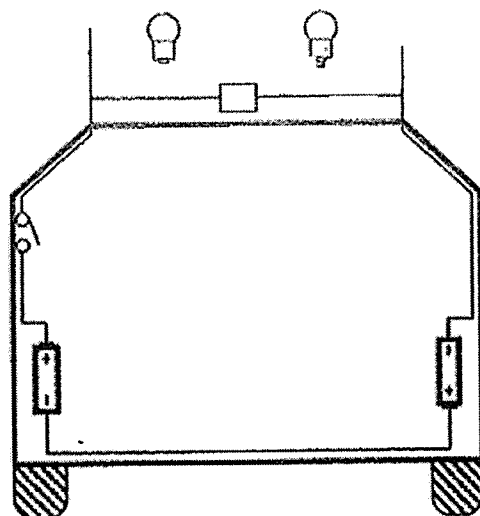

40. The diagram below shows a water feature in playground A.

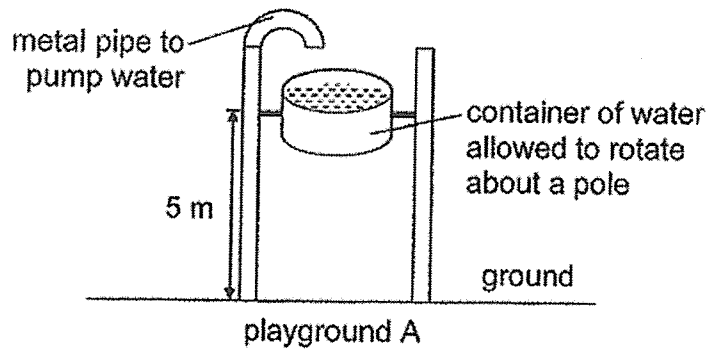

The container is slightly tilted forward and allowed to rotate about a pole attached to it. A metal pipe fills the container with water. When the water is filled to the brim, it tips forward and empties the water onto the ground below.

(a) State the main energy conversion that has occurred in the water when the container tips forward. [1]



The diagram below shows a similar water feature in playground B. Katy noted that the container in playground B was smaller than that in playground A and contained lesser amount of water.

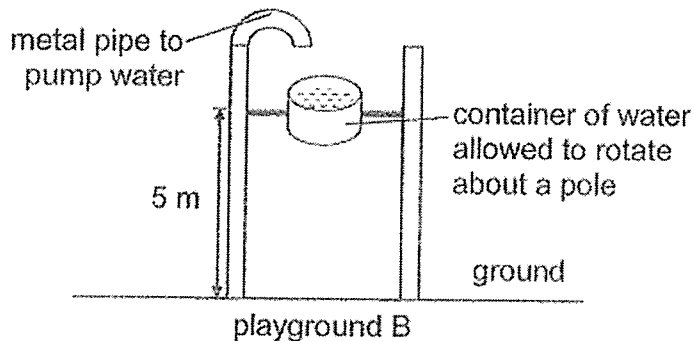

(b) Which container of water, the one in playground A or the one in playground B, would result in the water falling at a greater speed? Explain your answer. [1]



41. (a) What is a force?

[1]

The diagram below shows a parachutist with his parachute floating down to the ground after he has jumped off a plane. The parachute helps him fall to the ground slowly.

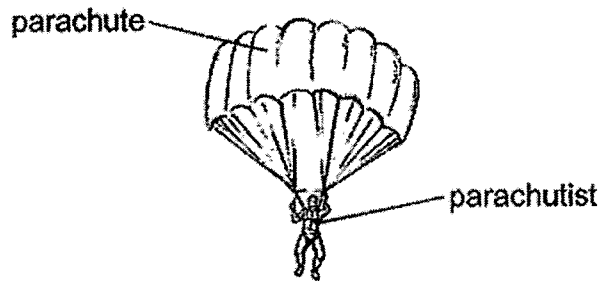

The graph shows the change in his speed of falling from the time he jumped off the plane until he safely landed on the ground.

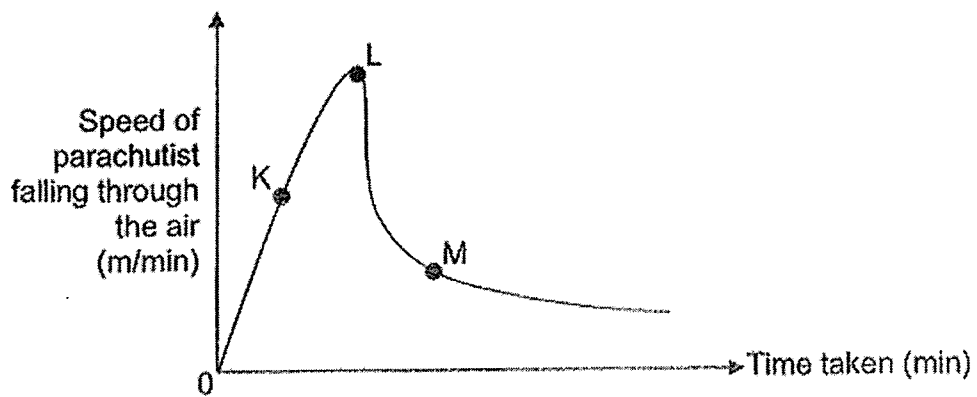

(b) At which point on the graph K, L or M, did the parachutist open his parachute? Explain your answer.

[2]

END OF PAPER



SCHOOL : CHIJ PRIMARY SCHOOL
LEVEL : PRIMARY 6
SUBJECT : SCIENCE
TERM : 2022 PRELIMS

SECTION A

Q 1	Q2	Q3	Q4	Q5	Q6	Q7	Q8	Q9	Q10
2	4	1	3	2	3	4	3	2	1
Q 11	Q12	Q13	Q14	Q15	Q16	Q17	Q18	Q19	Q20
2	2	4	2	4	4	1	2	3	4
Q 21	Q22	Q23	Q24	Q25	Q26	Q27	Q28		
1	1	3	3	1	2	3	1		

SECTION B

Q29)	<p>a) There was more than one changed variable that are the presence of paper petals and presence of drops of honey.</p> <p>b) Add four drops of honey to the paper disk in B, add 5 similar paper flower petals to set-up B.</p> <p>c) S. As both anthers and stigmas are hanging out of the flower to allow the wind to carry the pollen grains from the anther to the stigma.</p>
Q30)	<p>a) Chloroplast</p> <p>b) To destarch the plant before the start of the experiment.</p> <p>c) A similar pot with similar plant A in a similar sealed glass container but without the substance to remove carbon dioxide.</p>

	d) Amount of water available for plant A / temperature of surrounding air.			
Q31)	<p>a) When the population of plant Q increases, the population of plant R decreases.</p> <p>b) Change all the containers to opaque containers.</p> <p>c) Increase the number of plants Q used for the experiment.</p>			
Q32)	<p>a) A food chain shows food relationship between organisms.</p> <p>b) Some of the energy is being used by the organisms for life processes.</p>			
Q33)	<p>a) A can dig and maintain a burrow from hiding from predators.</p> <p>b) B has very good vision.</p> <p>c) B has a place to use for mating.</p> <p>d) Using its antennae to touch B's tail, A can know when there is danger as B would hide in the burrow when B senses danger this can help A, who has poor vision, to stay safe from predators.</p>			
Q34)	<p>a) The bark of the tree became darker as they were covered by the black dust particles found in the smoke given by the factory.</p> <p>b) Moth Y Moth X</p> <p>c) As the bark of the tree became darker over the years, the darker moth Y would blend in.</p>			
Q35)	<p>a)</p> <table border="1" style="margin-left: auto; margin-right: auto;"> <tr> <td style="padding: 5px;">F</td> <td style="padding: 5px;">G</td> <td style="padding: 5px;">E</td> </tr> </table> <p>b) F as F allows the least amount of light to pass through so that medicine P will not spoil easily.</p>	F	G	E
F	G	E		
Q36)	<p>a) Nickel</p> <p>b) Like poles of magnets repel each other when they face each other directly.</p> <p>c) Increase the number of coils of wire around metal Rod X.</p>			

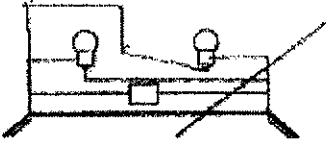
Q37)	<p>a) Y as air in glass Y is a poor conductor. The cooler water in Y gains heat slower from the warmer surrounding air as compared to the water in X.</p> <p>b) Temperature of water in both glasses at the start.</p> <p>c) K as K contains a thick layer of cotton which traps air which is a poor heat conductor. Thus his body will lose heat slower to the cooler surrounding air.</p>
Q38)	<p>a) Warmer Water vapour in the surrounding air (correct source) touches the cooler air above the crushed ice, loses heat and condenses to form tiny water droplets known as mist.</p> <p>b) To find out if the mass / amount of salt K added to the crushed ice affects the volume of water collected.</p> <p>c) The greater the amount of salt K added to the crushed ice, the greater the volume of water collected.</p> <p>d) Type of salt added to the crushed ice.</p>
Q39)	<p>a) Yes. When the switch is closed, the circuit becomes closed and electricity can flow through the circuit to light up both bulbs and siren.</p> <p>b) series</p> <p>c)</p> 
Q40)	<p>a) gravitational potential \rightarrow kinetic</p> <p>b) A, although both containers are at the same height of 5m above the ground, container A has a greater mass of water. More gravitational potential energy of water in A is converted into more kinetic energy of water in A resulting in water in A falling at a greater speed.</p>

Q41)	<p>a) A force is a push or a pull.</p> <p>b) L, as point L, his falling speed started to decrease as when he opened the parachute, there was greater air resistance.</p>
------	--