

Founded 1947

南侨小学

NAN CHIAU PRIMARY SCHOOL
PRELIMINARY EXAMINATION
2022
MATHEMATICS PAPER 1
PRIMARY 6
BOOKLET A

Name / Index #		()
Class	Primary 6 _____	
Date	19 August 2022	
Duration for Booklets A and B	1h	
Marks	Paper 1 Booklet A	20
	Paper 1 Booklet B	25
	Paper 2	55
	Total	100
Parent's Signature		

- | | |
|--------------------------|---|
| Instructions to students | <ol style="list-style-type: none">1. Do NOT open this booklet until you are told to do so.2. Follow all instructions carefully.3. Answer all questions.4. Shade your answers in the Optical Answer Sheet provided.5. The use of calculators is NOT allowed. |
|--------------------------|---|

This paper consists of 5 pages altogether.

Questions 1 to 10 carry 1 mark each. Questions 11 to 15 carry 2 marks each.
 For each question, four options are given. One of them is the correct answer.
 Make your choice and shade your answer (1, 2, 3 or 4) on the Optical Answer Sheet.

(20 marks)

1 What is the value of the digit 9 in 485 093?

- (1) 9000
- (2) 900
- (3) 90
- (4) 9

2 Arrange the following numbers from the smallest to the largest.

5	5.6	5.06
---	-----	------

- | | <u>Smallest</u> | | <u>Largest</u> |
|-----|-----------------|---|----------------|
| (1) | 5.06 | , | 5.6 |
| (2) | 5.6 | , | 5.06 |
| (3) | 5 | , | 5.06 |
| (4) | 5 | , | 5.6 |

3 In the number line, what is the mixed number represented by A?

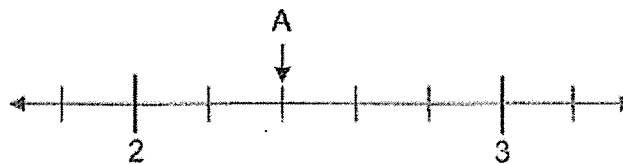

- (1) $2\frac{2}{5}$
- (2) $2\frac{1}{2}$
- (3) $2\frac{3}{5}$
- (4) $2\frac{2}{3}$

4 Find the sum of 305 and 139. Round the answer to the nearest hundred.

- (1) 400
- (2) 440
- (3) 444
- (4) 500

5 3 ones, 8 hundredths and 1 thousandth is _____.

- (1) 3.81
- (2) 3.801
- (3) 3.108
- (4) 3.081

6 Mrs Nathan took 30 minutes to drive from her house to her office. Her average driving speed was 90 km/h. What was the distance from her house to her office?

- (1) 27 km
- (2) 45 km
- (3) 120 km
- (4) 180 km

7 The figure shows a semicircle of diameter 12 cm.
What is the perimeter of the figure? Leave your answer in π .

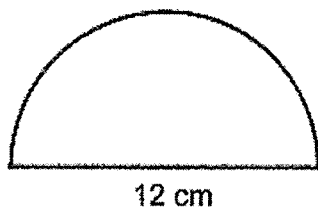

- (1) 6π cm
- (2) 18π cm
- (3) $(6\pi + 12)$ cm
- (4) $(12\pi + 12)$ cm

- 8 A school concert started at 3.40 p.m. and ended at 5.25 p.m.
How long was the concert?
- (1) 1 h 5 min
 (2) 1 h 15 min
 (3) 1 h 30 min
 (4) 1 h 45 min

- 9 AB and CD are straight lines.

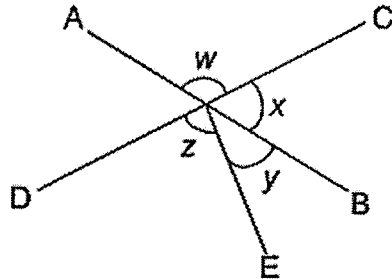

Which of the following is true?

- (1) $\angle W = \angle X + \angle Y$
 (2) $\angle Z = \angle W + \angle X$
 (3) $\angle W + \angle X + \angle Y = 180^\circ$
 (4) $\angle X + \angle Y + \angle Z = 180^\circ$
- 10 The following table shows the time taken by four students to complete a Mathematics test. One of the recorded data is covered by an ink blot.

Name	Time taken in minutes
Anna	
Belinda	80
Colin	74
Danny	70

The average time taken by the four students was 72 minutes.
What was the time taken by Anna to complete the test?

- (1) 36
 (2) 64
 (3) 72
 (4) 74

- 11 Mary had \$350. She spent the same amount of money each day. After 5 days, she was left with $\frac{4}{5}$ of her money. How much did she spend each day?

- (1) \$14
- (2) \$15
- (3) \$56
- (4) \$70

- 12 A repeated pattern is formed using the digits 1 and 0. The first 15 numbers are shown below.

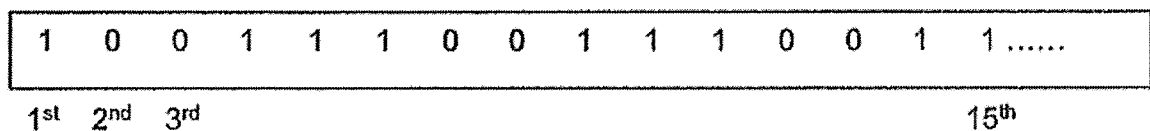

What is the sum of the first 99 numbers?

- (1) 57
 - (2) 59
 - (3) 60
 - (4) 62
- 13 Mrs Lim has a jug which contains 5 l of water. She uses the water to fill some identical cups to the brim. The capacity of each cup is $\frac{4}{5}$ l. At most, how many such cups can she fill to the brim?

- (1) 4
- (2) 5
- (3) 6
- (4) 7

- 14 The price of an e-dictionary was \$45 after a discount of 10%. Rina was then given an additional discount of \$9. What was the total percentage discount given to Rina for the e-dictionary?

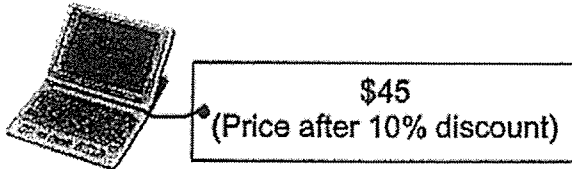

- (1) 18%
(2) 20%
(3) 28%
(4) 30%
- 15 Fadilah pours the same amount of water into two empty tanks A and B shown below.

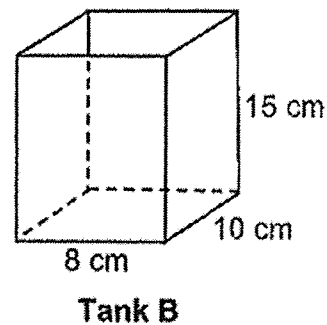
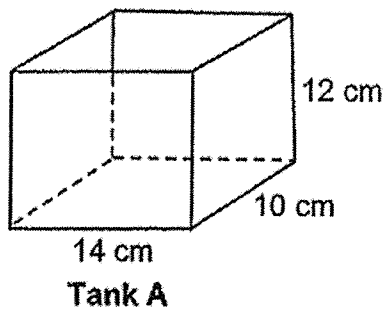

Tank A is half-filled with water. What is the height of water in Tank B?

- (1) 5.6 cm
(2) 6 cm
(3) 7.5 cm
(4) 10.5 cm

End of Paper 1 Booklet A

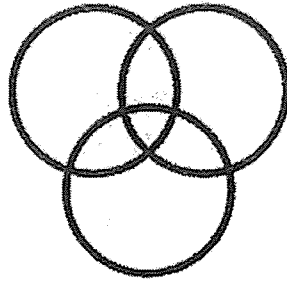

Founded 1947

南侨小学

NAN CHIAU PRIMARY SCHOOL
PRELIMINARY EXAMINATION
2022
MATHEMATICS PAPER 1
PRIMARY 6
BOOKLET B

Name / Index #		()
Class	Primary 6 _____	
Date	19 August 2022	
Duration for Booklets A and B	1h	
Marks	Booklet B	25
Parent's Signature		

- | | |
|--------------------------|---|
| Instructions to students | <ol style="list-style-type: none">1. Do NOT open this booklet until you are told to do so.2. Follow all instructions carefully.3. Answer all questions.4. Write your answers in this booklet.5. Use a dark blue or black ballpoint pen to write your answers in the space provided for each question.6. Do not use correction fluid/tape or highlighters.7. The use of calculators is NOT allowed. |
|--------------------------|---|

This paper consists of 10 pages altogether.

Questions 16 to 20 carry 1 mark each. Write your answers in the spaces provided. For questions which require units, give your answers in the units stated. (5 marks)

Do not write in this space

16 Write down all the common factors of 20 and 36 that are greater than 1.

Ans: _____

17 Square ACEG is made up of 4 small triangles, 1 large triangle and 1 small square. $AB = BC = CD$. What fraction of the square ACEG is shaded?

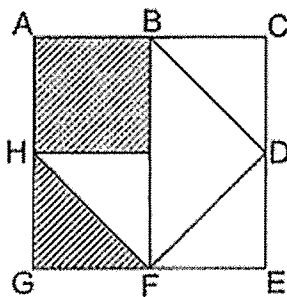

Ans: _____

18 Express $5\frac{4}{11}$ as a decimal. Give your answer correct to 1 decimal place.

Ans: _____

- 19 A container contained some water at first as shown below.
Harry used 0.06 l of water from the container. How much water was left?

Do not write
in this space

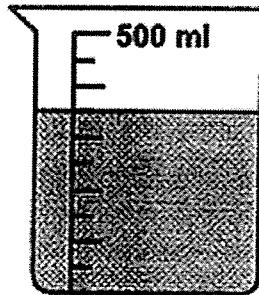

Ans: _____ l

- 20 In the figure below, DFE and DFG are isosceles triangles. $FD = FE = FG$.
 $\angle FDG = 35^\circ$. Find $\angle FDE$.

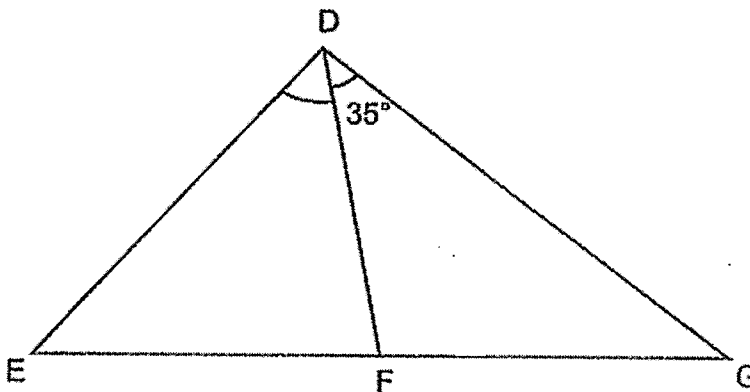

Ans: _____ °

Questions 21 to 30 carry 2 marks each. Show your working clearly and write your answers in the spaces provided. For questions which require units, give your answers in the units stated. (20 marks)

Do not write
in this space

- 21 The figure below is made up of 5 identical rectangles.
The breadth of one rectangle is 8 cm. What is the area of the figure?

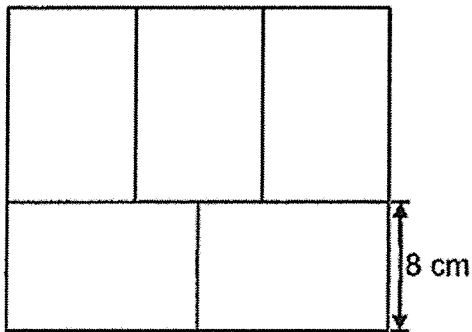

Ans: _____ cm²

- 22 Samantha has some blue, pink and white beads.
 $\frac{7}{10}$ of the beads are blue. There are twice as many pink beads as white beads. What fraction of the beads is white?

Ans: _____

- 23 Shop A and shop B sold an identical television each at the same price, after the discounts shown below. What was the usual price of the television sold by shop A?

Do not write
in this space

Shop A

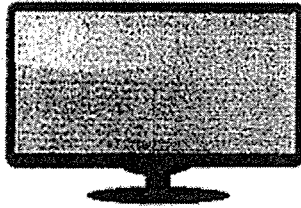

40% Discount
Usual Price: ?

Shop B

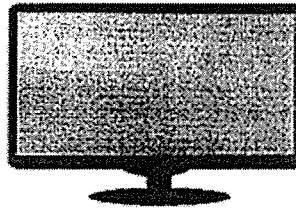

20% Discount
Usual Price: \$1500

Ans: \$ _____

- 24 Matthew spent a total of \$15 on some rulers and pens. He bought 27 pens at 9 pens for \$y. He bought the rulers at \$2 each. How many rulers did he buy?

Ans: _____

25 Jason builds a solid using 10 unit cubes and glued them together.

Do not write
in this space

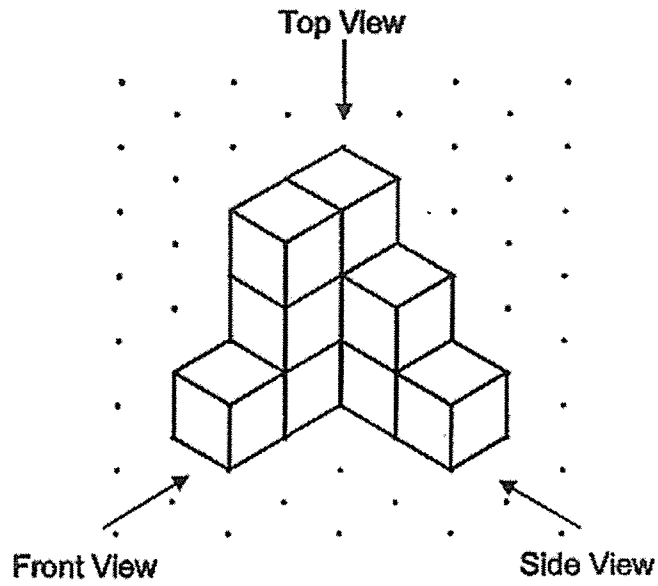

(a) Draw the top view on the grid below.

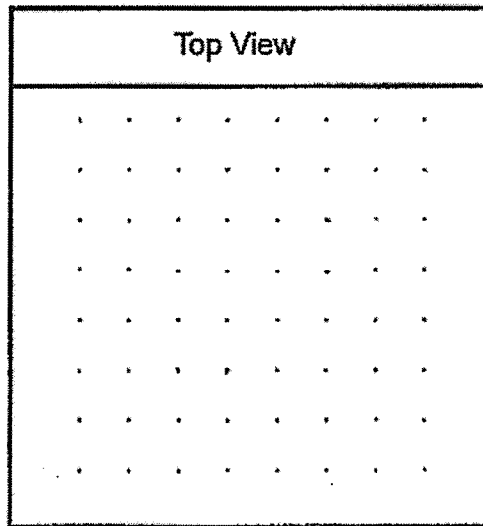

(b) Find the smallest number of unit cubes Jason can add to the solid to form a cubical solid.

Ans: (b) _____

- 26 The figure below is made up of 4 identical quadrants and a square.
What is the area of the shaded part? (Take $\pi = \frac{22}{7}$)

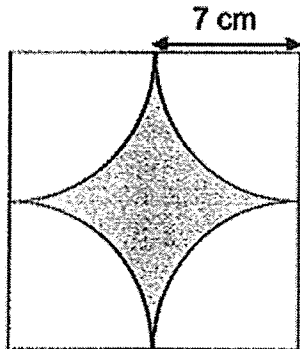

Do not write
in this space

Ans: _____ cm²

- 27 Billy's house, the library, the market, the pond and his school are located as shown in the square grid below.

Do not write in this space

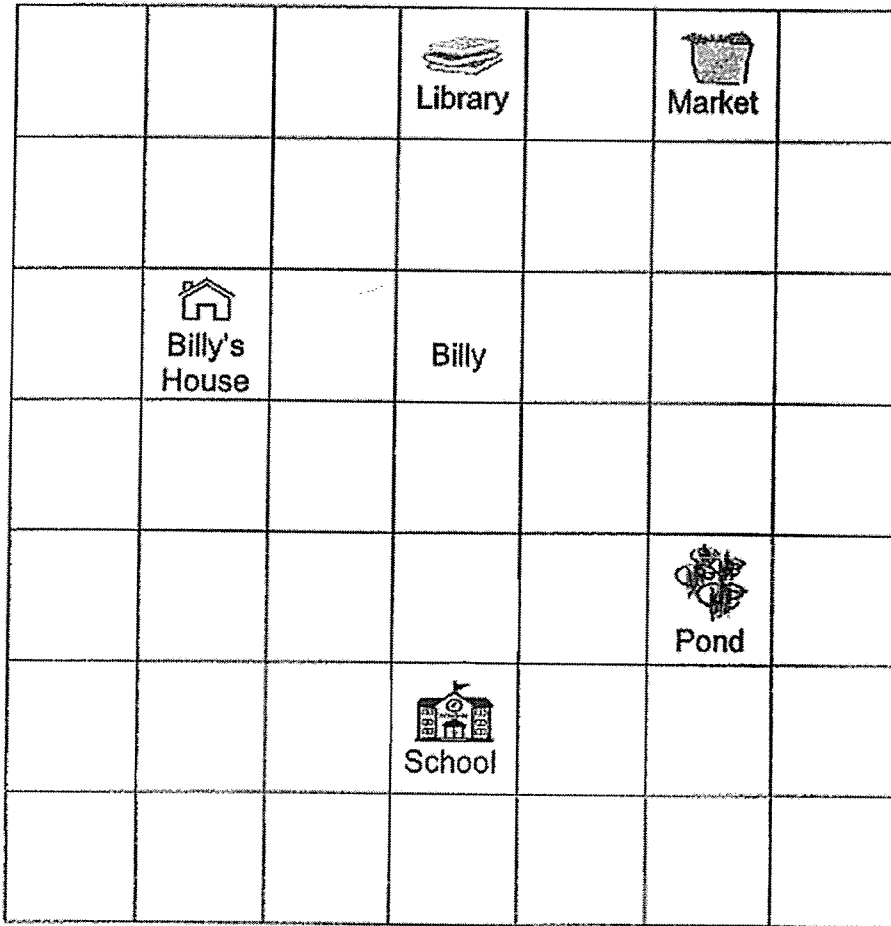

- (a) Billy is facing the pond. Where will he be facing after he turns 135° anti-clockwise?

Ans: (a) _____

- (b) A shopping mall will be built at a location south-east of Billy's house and north of the school. Put a tick (✓) in the square where the shopping mall will be built.

--

28

The diagram below shows two parallelograms ABCD and ABGE.
 $\angle AEG = 45^\circ$ and $\angle BCD = 60^\circ$.

Do not write
in this space

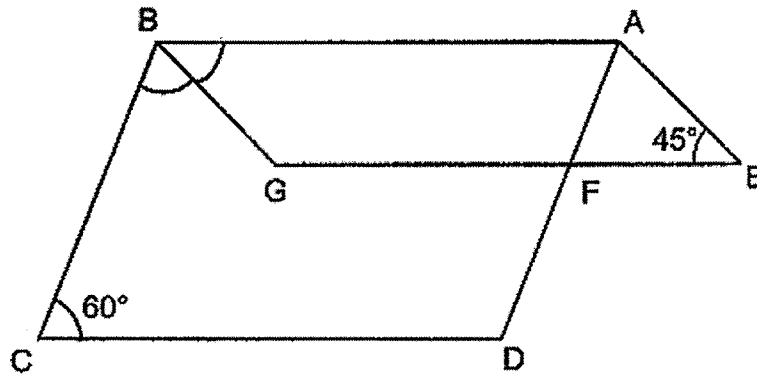

(a) Find $\angle ABG$.

Ans:(a) _____^o

(b) Find $\angle CBG$.

Ans: (b) _____^o

- 29 The line graph shows the amount of water in a tank from 10 a.m. to 2 p.m.
 The tank was $\frac{1}{4}$ filled with water at 10 a.m. Water flowed out of the tank from 10 a.m. to 2 p.m.

Do not write
in this space

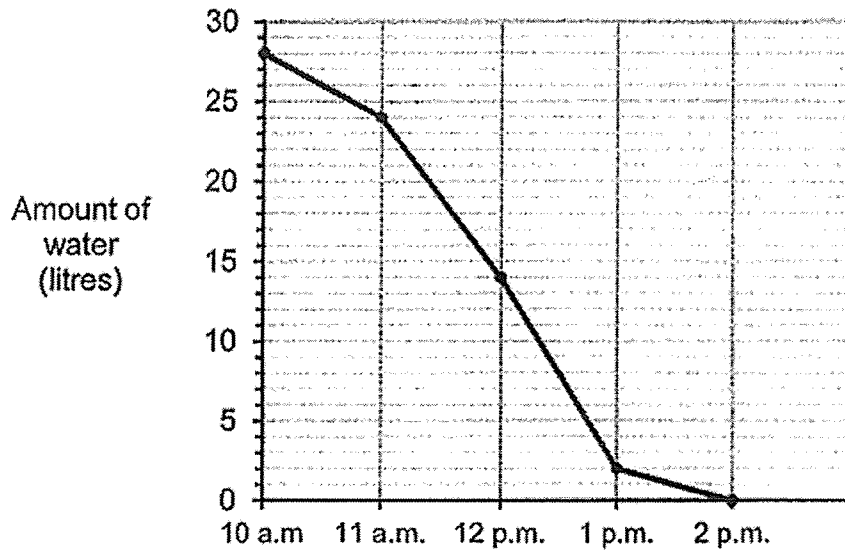

- (a) During which one hour interval was the flow of water out of the tank the greatest?

Ans: (a) _____ to _____

- (b) At 11 a.m., what fraction of the tank was filled with water ?

Ans: (b) _____

30 The pie chart shows how a group of students travel to school.

Do not write in this space

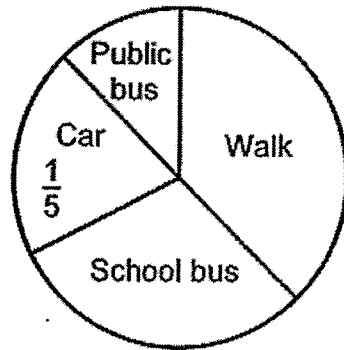

The bar graph also represents how the same group of students travel to school. The bar for the number of students who travel to school by public bus has not been drawn.

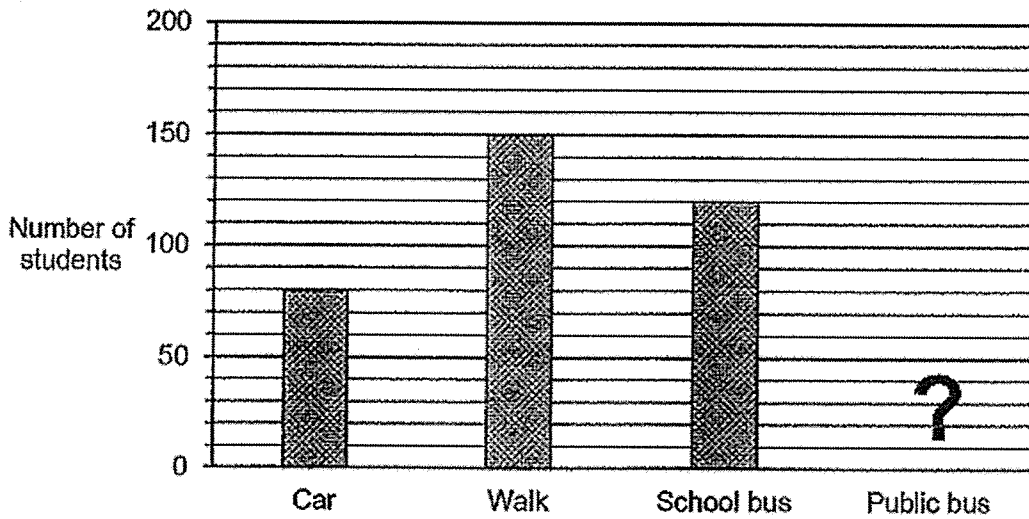

Each of the statements below is either true, false or not possible to tell from the information given. For each statement, put a tick (✓) to indicate your answer.

Statement	True	False	Not possible to tell
There are 400 students altogether.			
$\frac{3}{5}$ of the students walk to school.			
50 students take public bus to school.			

End of Paper 1 Booklet B

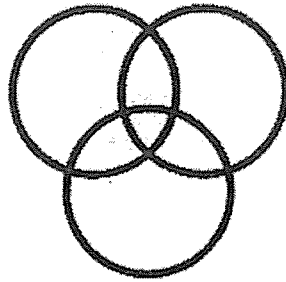

Founded 1947

南侨小学

**NAN CHIAU PRIMARY SCHOOL
PRELIMINARY EXAMINATION
2022
MATHEMATICS PAPER 2
PRIMARY 6**

Name / Index #		()
Class	Primary 6 _____	
Date	19 August 2022	
Duration for Paper 2	1h 30min	
Marks	Paper 2	55
Parent's Signature		

- | | |
|--------------------------|--|
| Instructions to students | <ol style="list-style-type: none">1. Do NOT open this booklet until you are told to do so.2. Follow all instructions carefully.3. Answer all questions.4. Use a dark blue or black ballpoint pen to write your answers in the space provided for each question.5. Do not use correction fluid/tape or highlighters.6. The use of an approved calculator is allowed. |
|--------------------------|--|

This paper consists of 15 pages altogether.

Questions 1 to 5 carry 2 marks each. Show your working clearly and write your answers in the spaces provided. For questions which require units, give your answers in the units stated. (10 marks)

Do not write in this space

- 1 (a) Use all the digits 3, 4, 5, 8 to form the greatest multiple of 5.

Ans: (a) _____

- (b) Use all the digits 3, 4, 5, 8 to form the smallest odd number between 4000 and 5000.

Ans: (b) _____

- 2 The number of red balloons is $\frac{2}{11}$ of the number of blue balloons. There are 1953 more blue balloons than red balloons. How many red balloons are there?

Ans: _____

- 3 The figure is made up of an equilateral triangle ABC and a square BCDE. DE = 2w cm. The perimeter of the figure is 140 cm. Find the value of w.

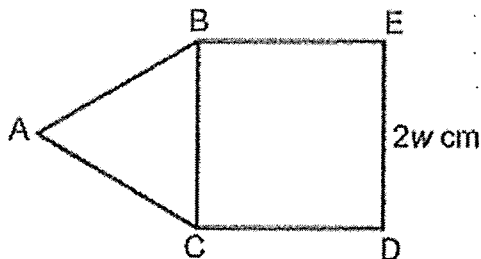

Ans: _____

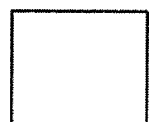

4 In the square grid below, line BC has been drawn.

Do not write
in this space

- (a) Draw a line parallel to line BC, passing through Point A.
- (b) Draw a right-angled triangle BCD, such that line $BC = CD$ and BC is perpendicular to line CD.

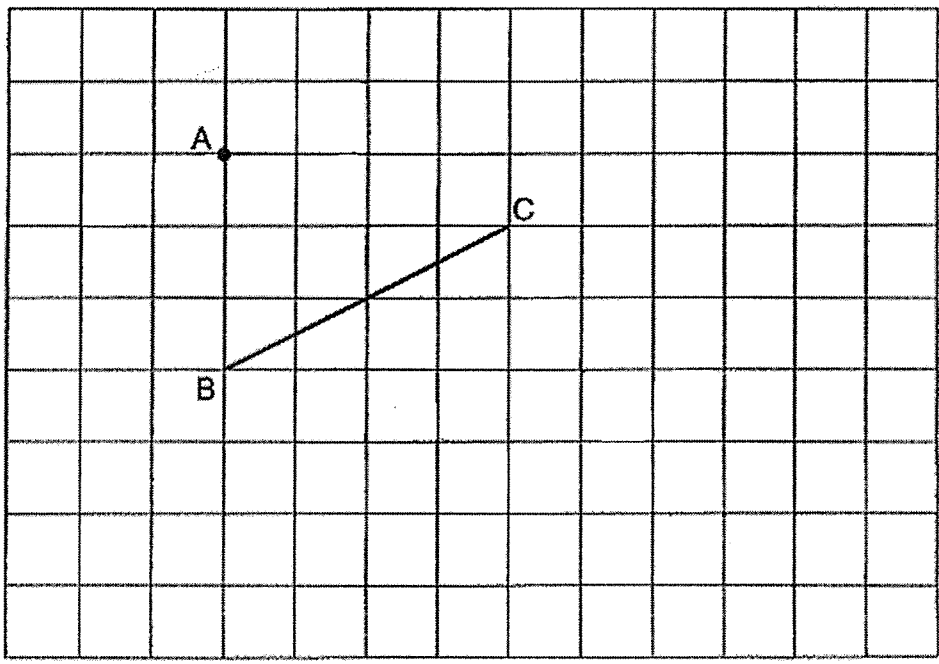

Score:

5 The graph shows the fare a taxi company charges for the first 10 kilometres.

Do not write
in this space

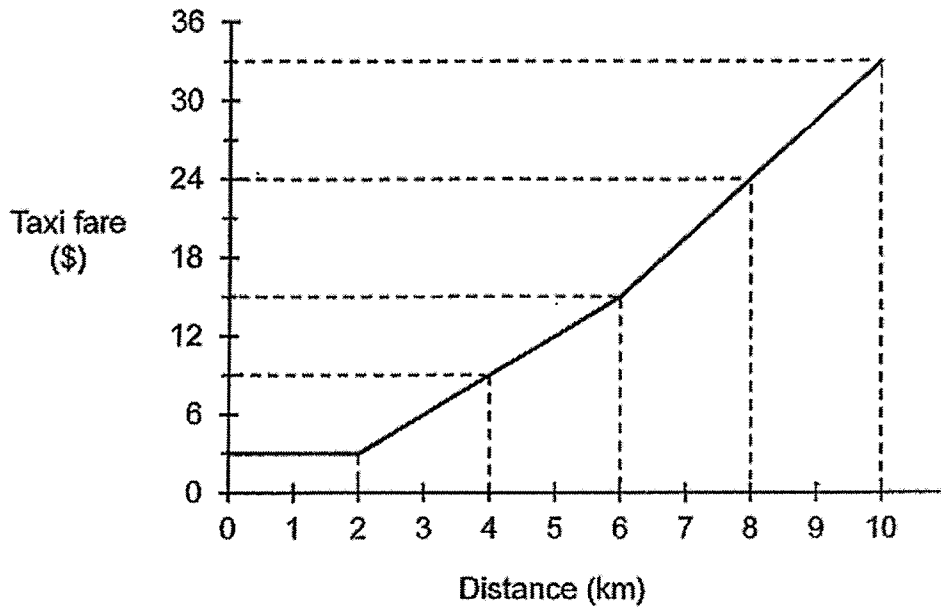

John took a taxi and travelled for 9 km. How much did he pay?

Ans: \$ _____

For questions 6 to 17, show your working clearly and write your answers in the spaces provided. The number of marks available is shown in the bracket [] at the end of each question or part-question. (45 marks)

Do not write
in this space

- 6 Simon could buy 9 notebooks and 54 pencils with \$64.80. With that same amount of money, he could buy 24 notebooks. He then decided to buy only pencils. What was the most number of pencils Simon could buy with \$64.80?

Ans: _____ [3]

7 Two machines, X and Y, cut shapes at the rate shown below.

Do not write
in this space

Machine X
12 pieces per second

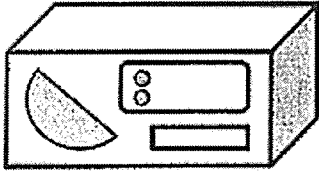

Machine Y
20 pieces every 3 seconds

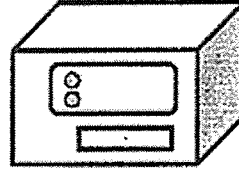

Machine X started cutting the shapes at 08 00 and it stopped at 08 30.
Machine Y cut shapes for 45 minutes.
How many shapes were cut in total by the two machines?

Ans: _____ [3]

- 8 PQRS is a parallelogram. TSR and QVU are straight lines.
 PST and SRU are isosceles triangles. $PT = PS$ and $SR = SU$.

Do not write
 in this space

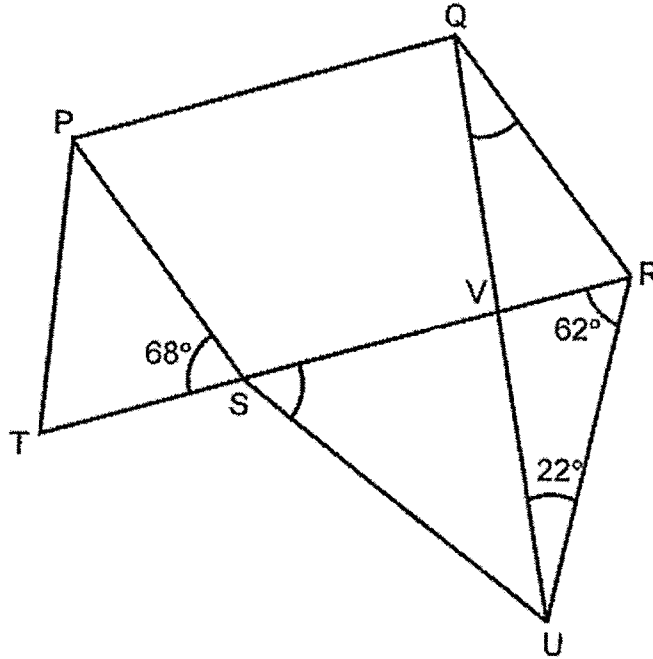

(a) Find $\angle RSU$.

Ans: (a) _____ [1]

(b) Find $\angle UQR$.

(b) _____ [2]

- 9 The bar graph shows the number of cups of tea sold by a shop from June to September. The number of cups of tea sold is not shown on the scale.

Do not write
in this space

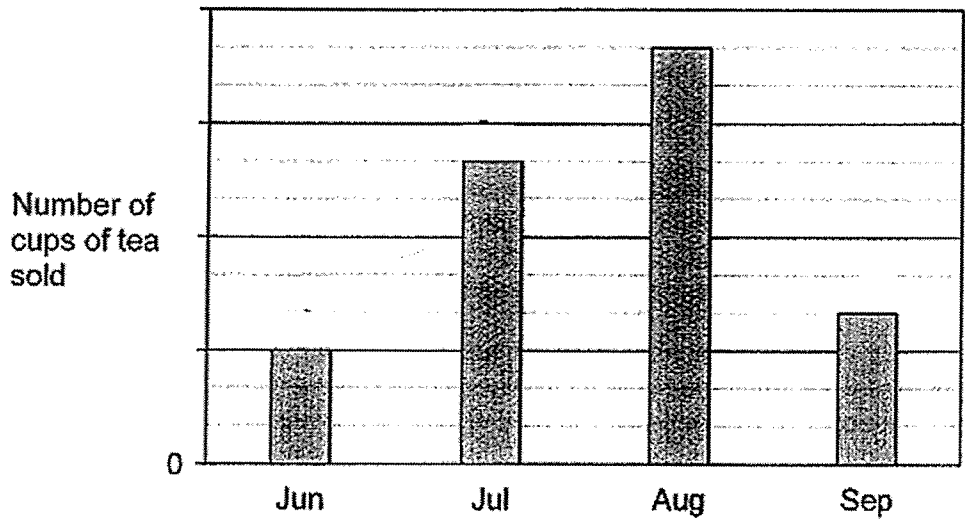

- (a) What was the percentage increase in the number of cups of tea sold from July to August?

Ans: (a) _____ [1]

- (b) The average number of cups of tea sold per month from June to September was 845. How many cups of tea were sold in September?

(b) _____ [2]

- 10 In the figure below, the diameters of three different semicircles form the sides of a right-angled triangle ABC. $AB = 12$ cm, $BC = 16$ cm and $AC = 20$ cm. Find the total area of the shaded parts. (Take $\pi = 3.14$)

Do not write
in this space

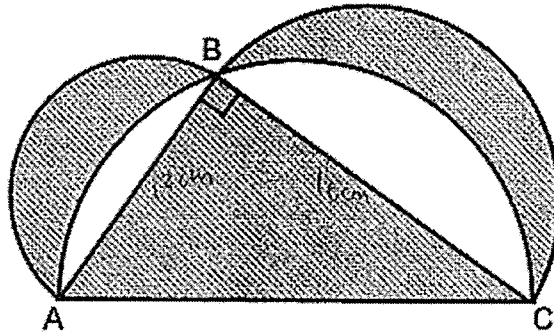

Ans: _____ [4]

- 11 Anne, Beth and Crystal bought a present for their friend. The ratio of the amount Anne paid to the total amount Beth and Crystal paid was 3 : 5. The ratio of the amount Crystal paid to the total amount Anne and Beth paid was 2 : 3. Crystal paid \$21 more than Beth.
Who paid the least for the present? How much did she pay for the present?

Do not write
in this space

Ans: _____ paid the least.

Amount paid: _____ [3]

- 12 Mrs Raja made some pineapple tarts and nutella tarts. She sold $\frac{7}{10}$ of her tarts. 75% of the tarts sold were nutella tarts. She sold 350 pineapple tarts. 30% of the unsold tarts were pineapple tarts. How many pineapple tarts were not sold?

Do not write
in this space

Ans: _____ [3]

13 In a shop, erasers and pencils are sold only in boxes.

Do not write
in this space

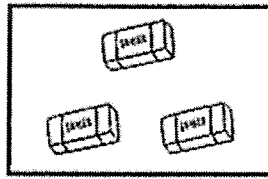

Box of 3 erasers
\$5.20 per box

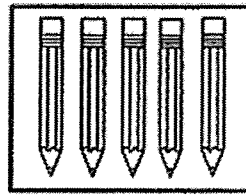

Box of 5 pencils
\$6.65 per box

- (a) Mrs Lim wants to get 40 erasers and 78 pencils for her students. What is the least amount of money she will need to spend on the erasers and pencils?

Ans: (a) _____ [2]

- (b) Mr Wong spent \$328.30 to buy a total of 57 boxes of erasers and pencils. How many boxes of pencils did he buy?

(b) _____ [2]

14 JKLM is a parallelogram, folded along line OP.

Do not write
in this space

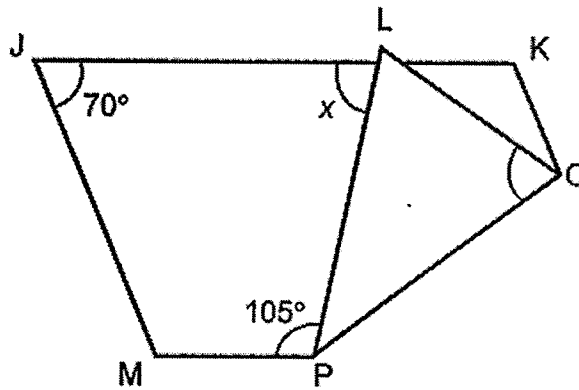

(a) Find $\angle x$.

Ans: (a) _____ [1]

(b) Find $\angle LOP$.

(b) _____ [2]

(c) Circle the words that describe Triangle LOP correctly in the following statement:

Triangle LOP (is / is not) an isosceles triangle because $\angle LOP$ (is / is not) the same as $\angle PLO$.

[1]

- 15 Mrs Sim baked some cookies and packed all the cookies in 14 small boxes and 3 large boxes. She filled each small box with the same number of cookies and each large box with the same number of cookies. There were 4 more cookies in each large box than in each small box. $\frac{7}{9}$ of the cookies baked were packed in the small boxes. How many cookies were there in each small box?

Do not write
in this space

Ans: _____ [5]

- 16 The figure below shows an empty container. A tap was turned on and water flowed into the container at a rate of 0.8 litres per minute. The tap was turned off 6 minutes later.

Do not write
in this space

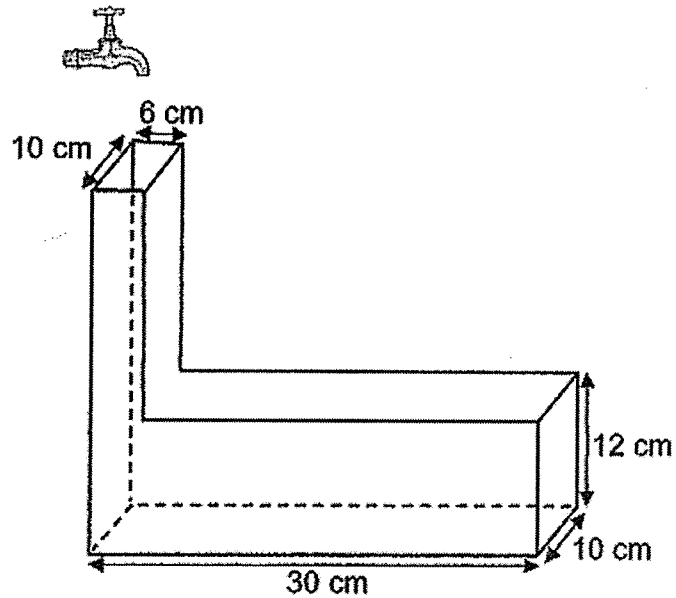

- (a) Find the height of the water level from the base of the container.

Ans: (a) _____ [3]

- (b) All the water was then poured into a cubical tank with a base area of 289 cm^2 . How much more water was needed to fill the tank to its brim?

(b) _____ [2]

- 17 Four identical right-angled triangles are used to form the figure shown below. $BC = 9$ cm. The perimeter of the figure is 72 cm.

Do not write
in this space

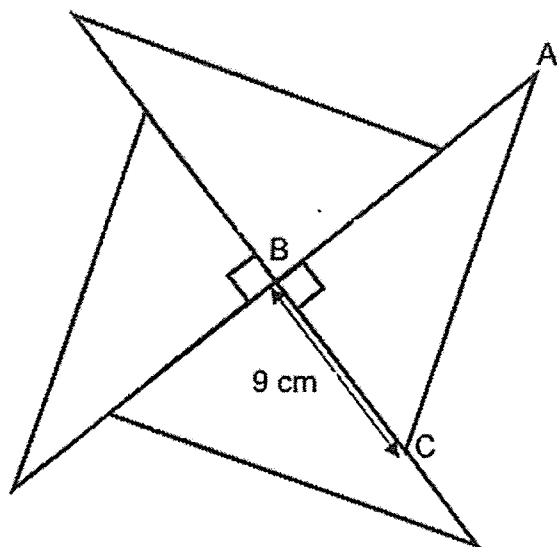

- (a) Find the perimeter of each right-angled triangle.

Ans: (a) _____ [2]

- (b) AC is 6 cm shorter than the total lengths of AB and BC. Find the area of the figure.

(b) _____ [3]

End of Paper

SCHOOL : NAN CHIAU PRIMARY SCHOOL
 LEVEL : PRIMARY 6
 SUBJECT : MATHEMATICS
 TERM : 2022 PRELIM

PAPER 1 BOOKLET A

Q 1	Q2	Q3	Q4	Q5	Q6	Q7	Q8	Q9	Q10
3	3	1	1	4	2	3	4	4	2

Q 11	Q12	Q13	Q14	Q15
1	2	3	3	4

PAPER 1 BOOKLET B

Q16)	2, 4
Q17)	$\frac{3}{8}$
Q18)	5, 4
Q19)	0.29ℓ
Q20)	$180 - 35 \times 2 = 110$ $180 - 110 = 70$ $(180 - 70) \div 2 = 55^\circ$
Q21)	$8 \times 3 \div 2 = 12$ $12 + 8 = 20$ $8 \times 3 = 24$ $20 \times 24 = 480\text{cm}^2$
Q22)	$\frac{1}{10}$
Q23)	$1500 \times \frac{80}{100} = 1200$ $1200 \times \frac{100}{60} = \2000
Q24)	$\left(\frac{15 - 3y}{2}\right)$

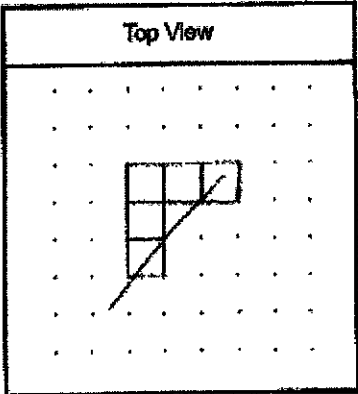
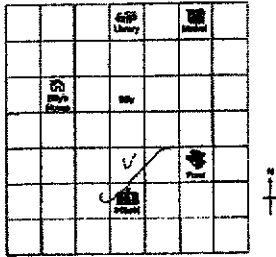
<p>Q25)</p>	<p>a)</p> <div style="text-align: center;">  <p>Top View</p> </div> <p>b) 17</p>									
<p>Q26)</p>	<p>$7 \times 7 \times \frac{22}{7} = 154$ $14 \times 14 = 196$ $196 - 154 = 42\text{cm}^2$</p>									
<p>Q27)</p>	<p>a) library b)</p> <div style="text-align: center;">  </div>									
<p>Q28)</p>	<p>a) 45° b) $180 - 60 = 120$ $120 - 45 = 75^\circ$</p>									
<p>Q29)</p>	<p>a) 12pm to 1pm b) $\frac{3}{14}$</p>									
<p>Q30)</p>	<div style="text-align: center;"> <table border="1" data-bbox="384 1626 660 1839"> <tr> <td>√</td> <td></td> <td></td> </tr> <tr> <td></td> <td>√</td> <td></td> </tr> <tr> <td>√</td> <td></td> <td></td> </tr> </table> </div>	√				√		√		
√										
	√									
√										

Q1)	a) 8435 b) 4385
Q2)	$11 - 2 = 9$ $1953 \div 9 = 217$ $217 \times 2 = 434$
Q3)	$140 \div 5 = 28$ $28 \div 2 = 14$
Q4)	
Q5)	$(33 - 24) \div 2 = 4.5$ $24 + 4.5 = \$28.50$
Q6)	$64.8 \div 24 = 2.7$ $64.8 - 2.7 \times 9 = 40.5$ $40.5 \div 54 = 0.75$ $64.8 \div 0.75 = 86.4$ ≈ 86
Q7)	$720 \times 30 = 21600$ $60 \div 3 = 20$ $20 \times 20 = 400$ $400 \times 45 = 18000$ $21600 + 18000 = 39600$
Q8)	a) $180 - 62 \times 2 = 56^\circ$ b) $180 - 68 = 112$ $180 - 112 = 68$ $180 - 68 - 62 - 22 = 28^\circ$
Q9)	a) $\frac{11-8}{8} \times 100\% = 37.5\%$ b) $845 \times 4 = 3380$ $3380 \div (3 + 8 + 11 + 4) = 130$ $730 \times 4 = 520$

Q10)	$12 \times 16 \div 2 = 96$ $20 \div 2 = 10$ $10 \times 10 \times \pi \div 2 = 50\pi$ $12 \div 2 = 6$ $6 \times 6 \times \pi \div 2 = 18\pi$ $16 \div 2 = 8$ $18\pi + 8 \times 8 \times \pi \div 2 = 50\pi$ $50\pi - (50\pi - 96) + 96 = 192\text{cm}^2$
Q11)	$3 : 5 = 15 : 25$ $2 : 3 = 16 : 24$ $25 - 16 = 9$ C : A : B $16 : 15 : 9$ $16 - 9 = 7$ $21 \div 7 = 3$ $3 \times 9 = 27$ Ans : Beth paid the least. Amount paid : \$27
Q12)	$100 - 75 = 25$ $\frac{7}{10} \times \frac{25}{100} = \frac{7}{40}$ $1 - \frac{7}{10} = \frac{3}{10}$ $\frac{3}{10} \times \frac{30}{100} = \frac{9}{100}$ $350 \div 7 \times 40 \div 100 \times 9 = 180$
Q13)	a) $40 \div 3 = 13\text{R}1$ $13 + 1 = 14$ $14 \times 5.2 = 72.8$ $78 \div 5 = 15\text{R}3$ $15 + 1 = 16$ $16 \times 6.65 + 72.8 = \179.20 b) $5.20 \times 57 = 296.4$ $328.3 - 296.4 = 31.9$ $6.65 - 5.2 = 1.45$ $31.9 \div 1.45 = 22$
Q14)	a) $180 - 70 = 110$ $360 - 110 - 70 - 105 = 75^\circ$

	<p>b) $(180 - 105) \div 2 = 37.5$ $180 - 37.5 - 70 = 72.5^\circ$</p> <p>c) is not / is not</p>
Q15)	<p>$\frac{7}{9} \div 14 \times 3 = \frac{1}{6}$</p> <p>$1 - \frac{7}{9} = \frac{2}{9}$</p> <p>$\frac{2}{9} - \frac{1}{6} = \frac{1}{18}$</p> <p>$4 \times 3 = 12$</p> <p>$(12 \times 8) \div 6 \div 3 = 12$</p>
Q16)	<p>a) $0.8\ell = 800ml$ $800 \times 6 = 4800$ $4800 - 12 \times 10 \times 30 = 1200$ $1200 \div 10 \div 6 = 20$ $20 + 12 = 32cm$</p> <p>b) $298 \times 17 - 4800 = 113cm^3$</p>
Q17)	<p>a) $(72 + 8 \times 9) \div 4 = 36cm$</p> <p>b) $(36 + 6) \div 2 - 9 = 12$ $12 \times 9 \times 2 = 216cm^2$</p>

