

METHODIST GIRLS' SCHOOL (PRIMARY)

Founded in 1887



PRELIMINARY EXAMINATION 2022 PRIMARY 6 MATHEMATICS

PAPER 1 BOOKLET A

Total Time for Booklets A and B: 1 hour

INSTRUCTIONS TO CANDIDATES

Do not turn over this page until you are told to do so.
Follow all instructions carefully.

Answer all questions.

Shade your answers in the Optical Answer Sheet (OAS)
provided.

The use of calculators is **NOT** allowed.

Name: _____ ()

Class: Primary 6. _____

Date: 19 Aug 2022

This booklet consists of **8** printed pages including this page.

Questions 1 to 10 carry 1 mark each. Questions 11 to 15 carry 2 marks each. For each question, four options are given. One of them is the correct answer. Make your choice (1, 2, 3 or 4). Shade the correct oval (1, 2, 3 or 4) on the Optical Answer Sheet. (20 marks)

1 Which one of the following fractions is nearest to 1?

(1) $\frac{2}{3}$

(2) $\frac{4}{5}$

(3) $1\frac{3}{4}$

(4) $1\frac{3}{10}$

2 What is the length of the ribbon below?

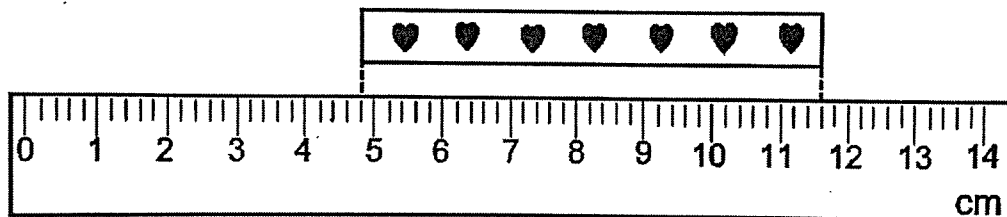

(1) 6.4 cm

(2) 6.8 cm

(3) 6.9 cm

(4) 11.6 cm

(Go on to the next page)

- 3 The pie chart below shows the favourite food of a group of children. What is the ratio of the number of children who like burger to the number of children who like pasta?

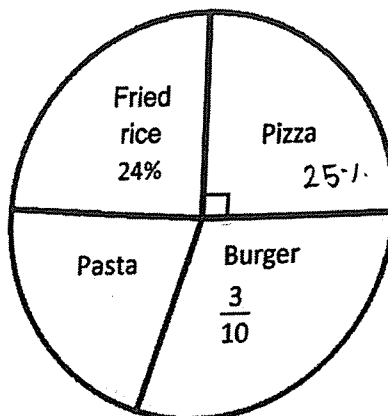

- (1) 1 : 7
 (2) 3 : 7
 (3) 6 : 5
 (4) 10 : 7

- 4 AB, CD and EF are straight lines. Find $\angle r$.

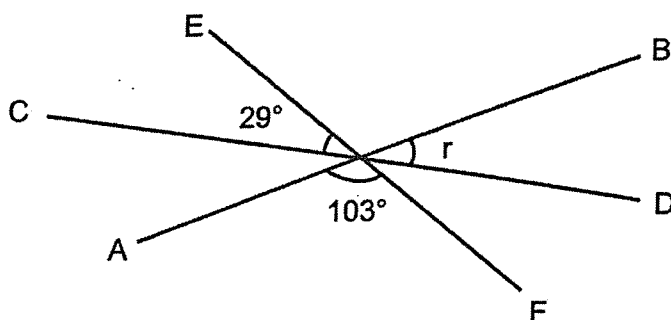

- (1) 29°
 (2) 48°
 (3) 61°
 (4) 77°

(Go on to the next page)

5 Express 1.8 as a percentage.

- (1) 0.018%
- (2) 0.18%
- (3) 1.8%
- (4) 180%

6 Which of the following are isosceles triangles?

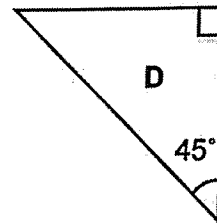
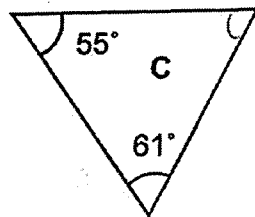
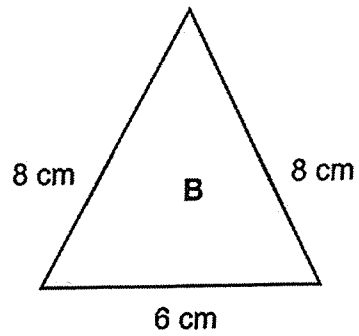
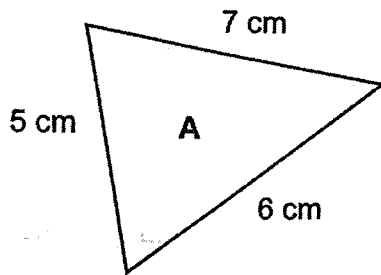

- (1) A and B only
- (2) B and C only
- (3) B and D only
- (4) A, B and D only

(Go on to the next page)

- 7 The product of two numbers is 55. One of the numbers is 5.
Find the average of the two numbers.

- (1) 8
- (2) 10
- (3) 11
- (4) 16

- 8 Adrian, Betty and Chandran shared 126 marbles in the ratio 2 : 4 : 3.
How many marbles did Betty have?

- (1) 14
- (2) 28
- (3) 42
- (4) 56

- 9 Mei Ling baked $5y$ tarts. She gave her mother 25 of them and packed the rest equally into 3 boxes. How many tarts were there in each box?

- (1) $\frac{5y}{3}$
- (2) $\frac{5y+25}{3}$
- (3) $\frac{5y}{3} - 25$
- (4) $\frac{5y-25}{3}$

10 The solid below is a prism.

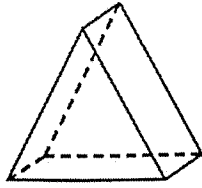

Which of the following nets can be folded to form the solid above?

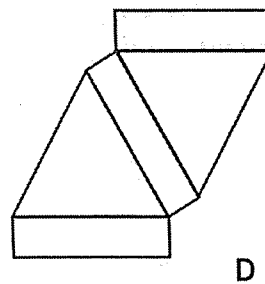
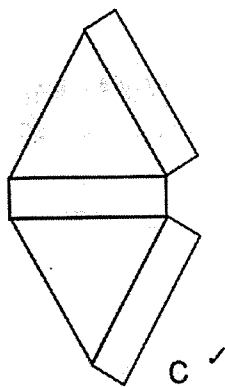
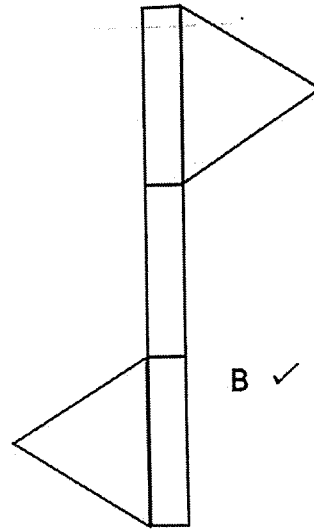
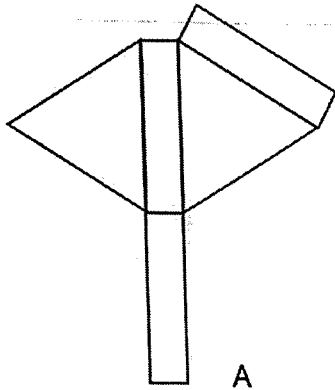

- (1) A and D only
 (2) B and C only
 (3) A, B and D only
 (4) B, C and D only

C20

(Go on to the next page)

- 11 The figure below is made up of 3 identical quarter circles with radius 7 cm.

Find its perimeter. (Take $\pi = \frac{22}{7}$)

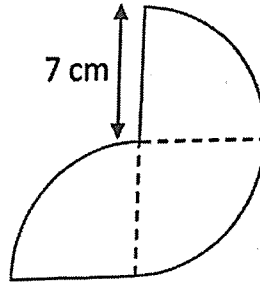

- (1) 47 cm
 (2) 75 cm
 (3) 115.5 cm
 (4) 129.5 cm

- 12 A piece of paper in the shape of an equilateral triangle is folded along the dotted line as shown. Find $\angle n$.

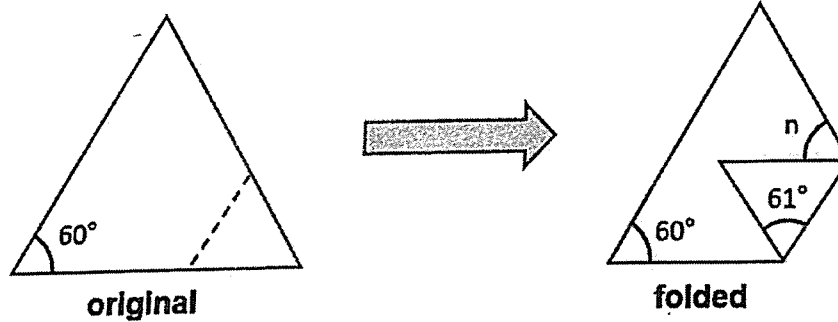

- (1) 59°
 (2) 60°
 (3) 61°
 (4) 62°

(Go on to the next page)

- 13 Joanna and Elicia had an equal number of stickers at first. After Joanna gave away 30 of her stickers and Elicia bought another 12 stickers, Elicia had four times as many stickers as Joanna. How many stickers did each of them have at first?

- (1) 36
 (2) 42
 (3) 44
 (4) 56

- 14 Mrs Chan only had the following coins in her wallet.



She took three coins from her wallet and dropped them into a donation box. Which one of the following could not be the amount she donated?

- (1) \$0.35
 (2) \$0.75
 (3) \$1.15
 (4) \$1.65
- 15 There were $\frac{5}{7}$ as many red marbles as blue marbles in a jar. Dave took some blue marbles out of the jar and replaced them with the same number of red marbles. The number of red marbles became $\frac{5}{9}$ of all the marbles in the jar. Which of the following is a possible number of blue marbles that were replaced?

- (1) 9
 (2) 10
 (3) 36
 (4) 63

METHODIST GIRLS' SCHOOL (PRIMARY)

Founded in 1887



PRELIMINARY EXAMINATION 2022 PRIMARY 6 MATHEMATICS

PAPER 1 BOOKLET B

Total Time for Booklets A and B: 1 hour

INSTRUCTIONS TO CANDIDATES

Do not turn over this page until you are told to do so.

Follow all instructions carefully.

Answer all questions.

Write your answers in this booklet.

The use of calculators is **NOT** allowed.

Name: _____

Class: Primary 6. _____

Date: 19 Aug 2022

Paper 1 Booklet B	/ 25
----------------------	------

This booklet consists of 9 printed pages including this page.

Questions 16 to 20 carry 1 mark each. Write your answers in the spaces provided. For questions which require units, give your answers in the units stated. (5 marks)

Do not write in this space.

16 Write down all the common multiples of 7 and 5 that are smaller than 120.

Ans: _____

17 Find the value of $2.7 \div 90$.

Ans: _____

18 Find the value of $\frac{2}{3} + \frac{4}{7}$.

Give your answer as a mixed number in the simplest form.

Ans: _____

(Go on to the next page)

- 19 Find the value of $\frac{9w-7}{5}$ when $w = 8$.

Do not
write in
this space.

Ans: _____

- 20 Megan took 45 minutes to travel from Point A to Point B at an average speed of 72 km/h. Find the distance between Point A and Point B.

Ans: _____ km

(Go on to the next page)

Questions 21 to 30 carry 2 marks each. Show your working clearly and write your answers in the spaces provided. For questions which require units, give your answers in the units stated. (20 marks)

Do not write in this space.

21

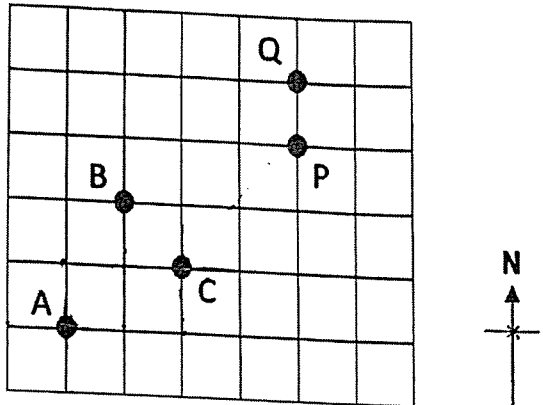

Based on the square grid above, fill in the blanks with A, B, C, P or Q.

(a) Point _____ is south of point _____

(b) Point _____ is north-east of point _____

22 The table shows the charges for bicycle rental.

Bicycle for Rental	
For the first 1 hour	\$6.00
For every additional 30 minutes or part thereof	\$2.50

Jane rented a bicycle from 5.30 p.m. to 7.45 p.m.
How much did she pay?

Ans: \$ _____

(Go on to the next page)

- 23 ABC is an equilateral triangle and ADEF is a square.
GAC is a straight line. Find $\angle BAD$.

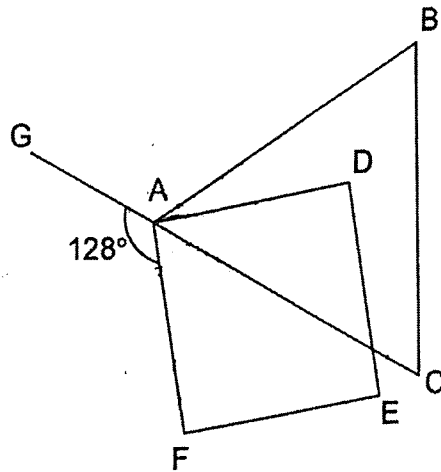

Ans: _____ $^\circ$

Do not
write in
this space.

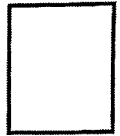

- 24 An empty tank has a rectangular base measuring 30 cm by 20 cm.
Water from 5 bottles is emptied into the tank without spillage.
Each bottle contains 1.5 l of water. What is the height of water in the tank?

Ans: _____ cm

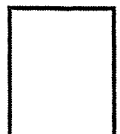

(Go on to the next page)

- 25 The solid below is made up of 10 cubes.
 Draw the front view and top view (as seen from the front view) of the solid in the grid below.

Do not write in this space.

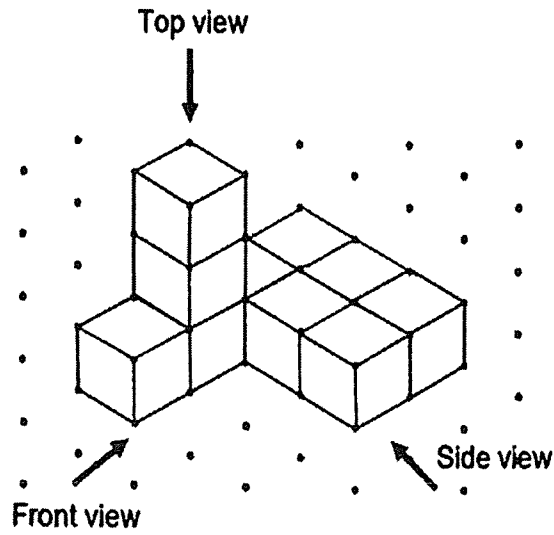

Ans:

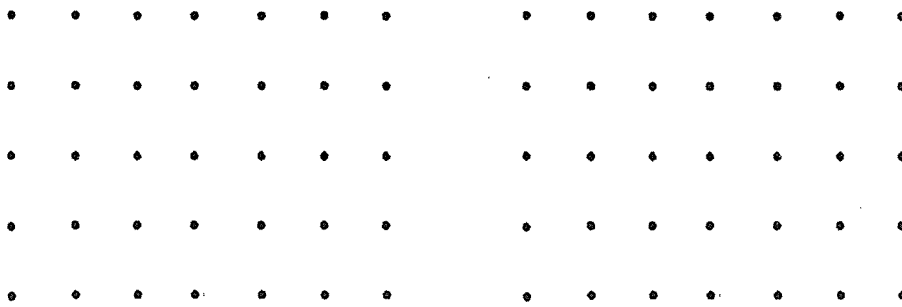

Front View

Top View

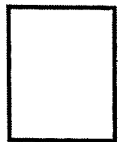

- 26 The figure is made up of 4 identical squares. $AE = EF$.
What fraction of the figure is shaded?

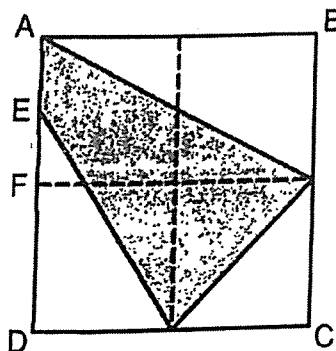

Ans: _____

- 27 Alan bought some stalks of flowers. 60% of them are roses and the rest are orchids. 50% of the roses are red roses. There are 24 red roses. How many stalks of orchids are there?

Ans: _____

(Go on to the next page)

- 28 Kim baked 259 more cookies than Li Min. After each of them sold some cookies, Kim had $\frac{2}{5}$ of her cookies left and Li Min had $\frac{3}{4}$ of her cookies left. Both Kim and Li Min had the same number of cookies left. How many cookies did Li Min bake at first?

Do not write in this space.

Ans: _____

- 29 A bookshop had 600 pens to sell over two weeks. In the first week, the ratio of the number of pens sold to the number of pens unsold was 1 : 2. In the second week, the ratio of the number of pens sold to the number of pens unsold was 5 : 3. How many pens did the bookshop sell in the second week?

Ans: _____

(Go on to the next page)

- 30 The bar graph below shows the height of 5 girls.

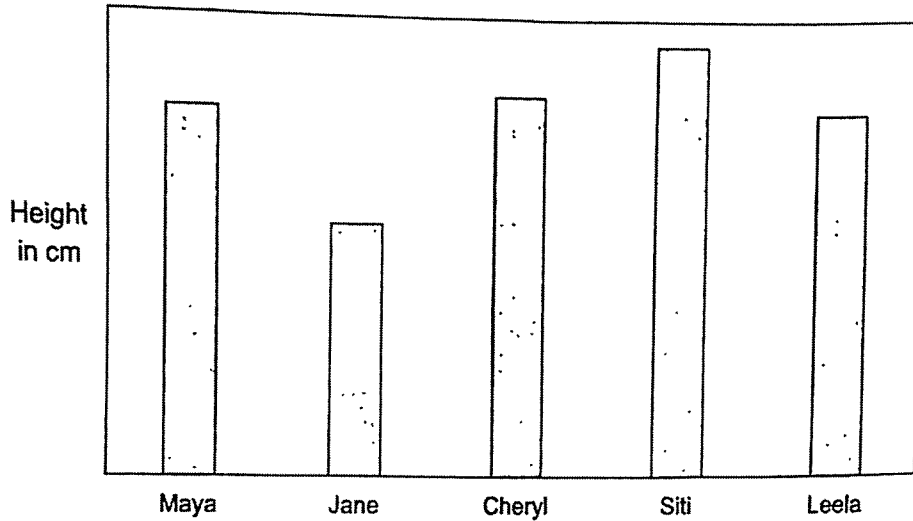

Do not write in this space.

Each statement below is either true, false, or not possible to tell from the information given. For each statement, put a tick (✓) in the correct column.

Statement	True	False	Not possible to tell
(a) Jane is 15 cm shorter than Maya.			
(b) The average height of the 5 girls is more than Jane's height but less than Siti's height.			
(c) The ratio of Jane's height to Siti's height is 1 : 2.			

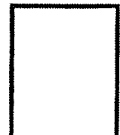

END OF PAPER

METHODIST GIRLS' SCHOOL (PRIMARY)

Founded in 1887



PRELIMINARY EXAMINATION 2022 PRIMARY 6 MATHEMATICS

PAPER 2

Duration: 1h 30 min

INSTRUCTIONS TO CANDIDATES

Do not turn over this page until you are told to do so.

Follow all instructions carefully.

Answer all questions.

Write your answers in this booklet.

The use of an approved calculator is expected, where appropriate.

Name: _____ ()

Class: Primary 6. 1

Date: 19 August 2022

Parent's Signature: _____

Paper 1 Booklet A	/ 20
Paper 1 Booklet B	/ 25
Paper 2	/ 55
TOTAL	/ 100

This booklet consists of 18 printed pages including this page.

Questions 1 to 5 carry 2 marks each. Show your working clearly and write your answers in the spaces provided. For questions which require units, give your answers in the units stated. (10 marks)

Do not write in this space

- 1 Prawns are sold at the supermarket at \$1.35 per 100 g. Kelly bought 3.5 kg of prawns. How much did she pay?

Ans: \$ _____

- 2 ABCD is a rhombus and CDEF is a square. $\angle BAD$ is 124° . Find $\angle BFC$.

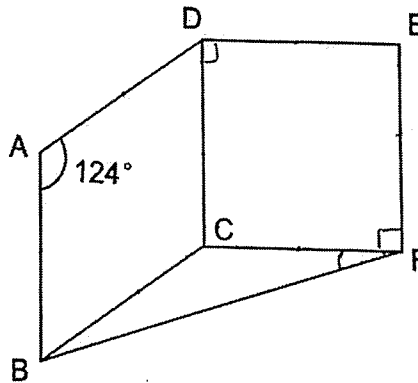

Ans: _____ $^\circ$

(Go on to the next page)

- 3 John saw two different advertisements for two identical rackets sold at \$180 before discount.

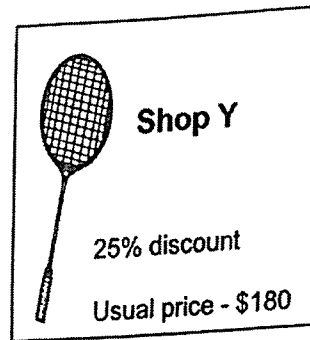

How much money did John save by buying from the cheaper shop?

Ans: \$ _____

Do not
write in
this space

- 4 ABCD is a square and AEFG is a rectangle. $AB = 24$ cm and $GF = 30$ cm. Point E lies on BC while Point D lies on FG. Find the length of AG.

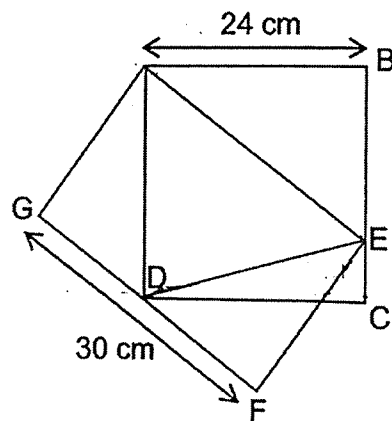

Ans: _____ cm

(Go on to the next page)

- 5 The figure below shows part of a symmetric figure.

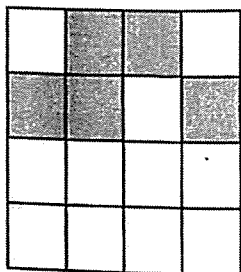

- (a) Using the given dotted line as the line of symmetry, complete the symmetric figure by shading the correct square(s) below. [1]

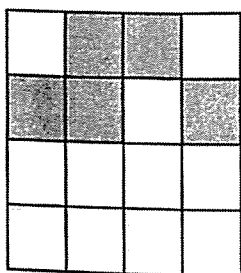

- (b) Jane used a **different** line of symmetry that required her to shade only two squares to complete a symmetric figure. Which two squares did Jane shade?

Shade in the figure below to show your answer. [1]

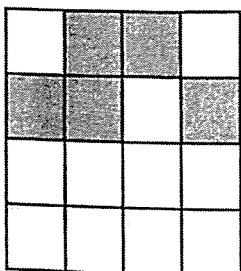

Do not
write in
this space

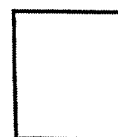
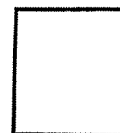

For questions 6 to 17, show your working clearly and write your answers in the space provided. The number of marks available is shown in brackets [] at the end of each question or part-question. (45 marks)

Do not write in this space

6 A pen costs \$ p . A notebook costs \$2 more than the pen.

- (a) What is the cost of 3 pens and 2 notebooks?
Express your answer in terms of p in its simplest form.

Ans: (a) _____ [1]

- (b) Lee Lian paid \$22.50 for 3 pens and 2 notebooks.
Find the cost of one notebook.

Ans: (b) _____ [2]

(Go on to the next page)

- 7 Su Ling wanted to buy a laptop with her savings.
The line graph below shows her savings at the end of each week.

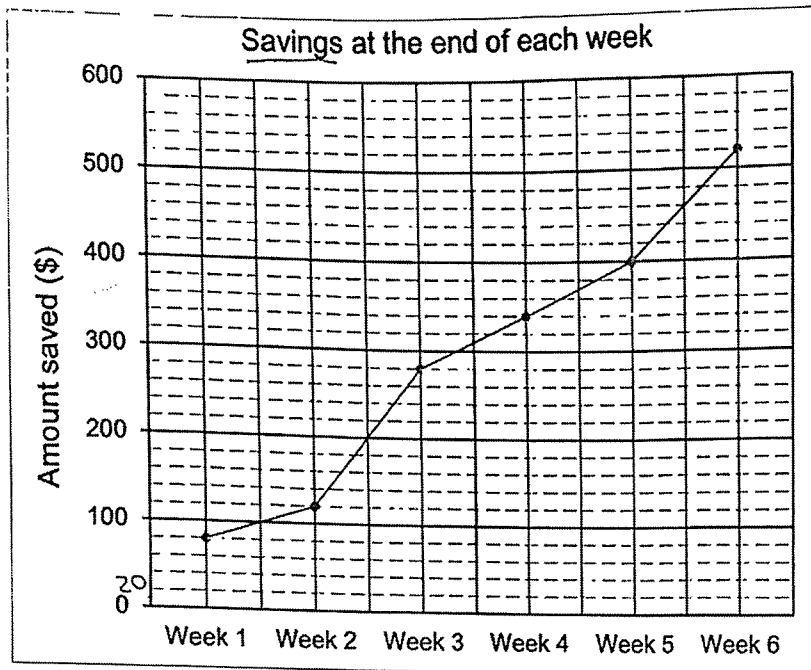

- (a) In which week did Su Ling save the most?

Ans: (a) _____ [1]

- (b) At the end of week 6, Su Ling only managed to save $\frac{1}{4}$ of the amount she needed to buy the laptop. How much more does she need to save?

Ans: (b) _____ [2]

Do not
write in
this space

- 8 Alex and Ben started cycling at the same time from the start of a 6.12 km cycling path. Both did not change their speeds from the start to finish. Alex cycled at 340 m/min. When he reached the end of the path, Ben was 450 m behind him. Find Ben's speed in m/min.

Do not
write in
this space

Ans: _____ [3]

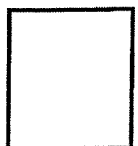

(Go on to the next page)

9 A right-angled triangle is drawn in the square grid below.

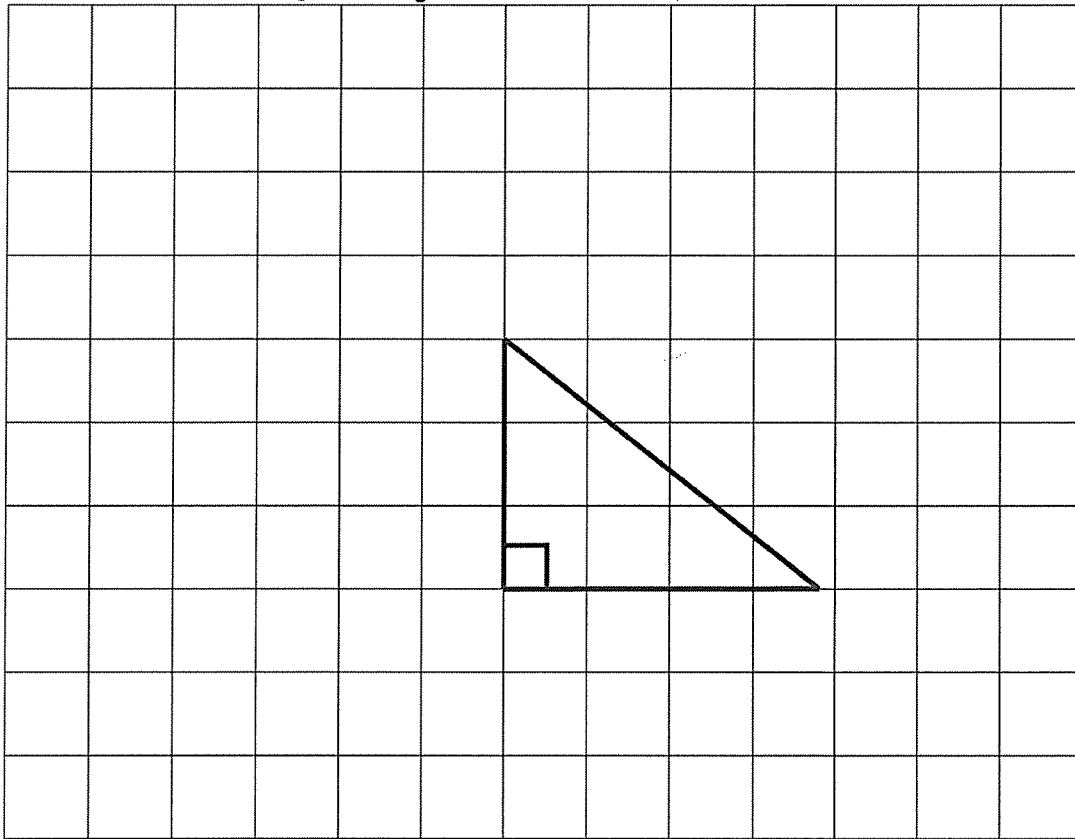

Do not write in this space

(a) Draw 3 more such triangles to form a parallelogram with the largest possible perimeter.

[2]

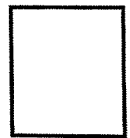

(b) Measure and write the length of the longest side of the parallelogram.

Ans: (b) _____ [1]

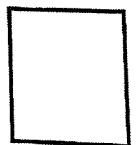

- 10 PSV is an isosceles triangle, $PS = VS$. RSTW is a rhombus. PT and RV are straight lines. $\angle WPQ = 35^\circ$ and $\angle PSV = 32^\circ$.

(a) Find $\angle TUS$.

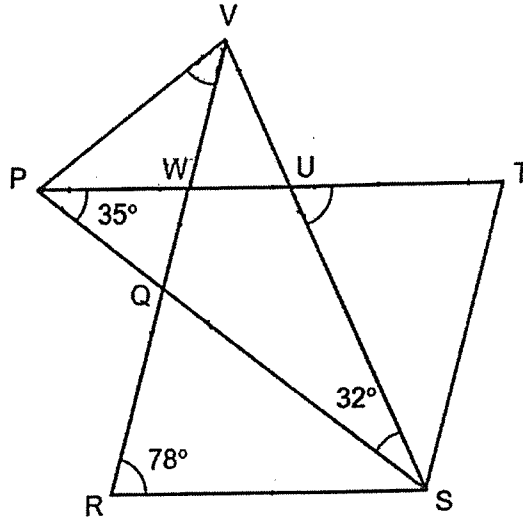

Do not write in this space

Ans: (a) _____ [2]

(b) Find $\angle PVR$.

Ans: (b) _____ [2]

- 11 The two bar graphs below show the number of members in a sports club who took part in 4 types of sports in March and April. The bar for the number of members who participated in Cycling in March has not been drawn.

Do not write in this space

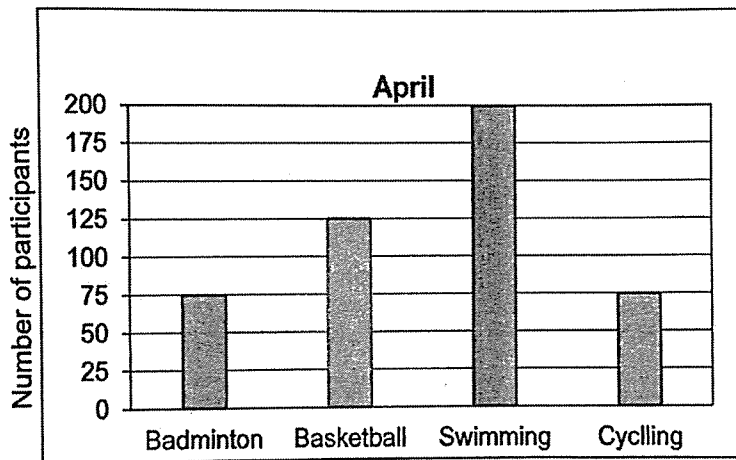
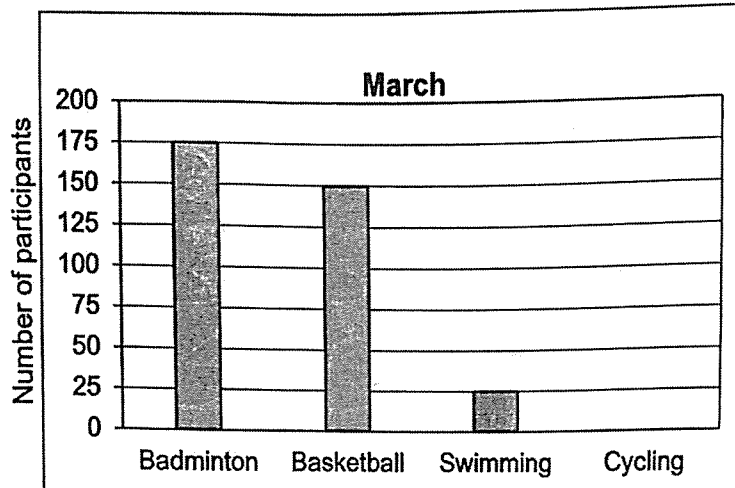

- (a) In March, the ratio of the number of people who took part in Basketball to the number of people who took part in Cycling was 3 : 2. How many people took part in Cycling in March?

Ans: (a) _____ [1]

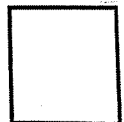

(Go on to the next page)

- (b) What was the percentage decrease in the number of people who took part in Badminton from March to April?
Give your answer correct to 2 decimal places.

Do not
write in
this space

Ans: (b) _____ [2]

- (c) An entrance fee was charged to those who took part in swimming. A total of \$528.75 was collected in March and April. How much was the entrance fee?

Ans: (c) _____ [1]

(Go on to the next page)

- 12 Two identical semicircles and two identical quadrants are cut out from a square piece of grey paper as shown below. Taking $\pi = \frac{22}{7}$,

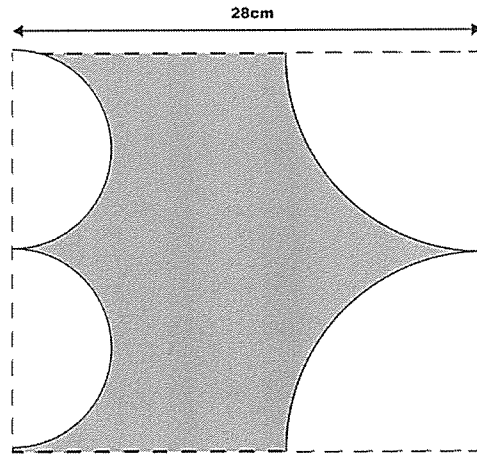

- (a) find the perimeter of the remaining paper.

Ans: (a) _____ [2]



- (b) find the area of the remaining paper.

Ans: (b) _____ [2]

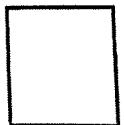

Do not
write in
this space

- 13 The average height of a group of children was 129.6 cm. One of the children's height was wrongly recorded as 162 cm when it should have been 126 cm. As a result, the average height calculated became 132.6 cm. How many children were there in the group?

Do not
write in
this space

Ans: _____ [3]

(Go on to the next page)

- 14 Mariam baked some strawberry, apple and pear tarts. There were 12 more strawberry tarts than pear tarts and 20 more apple tarts than strawberry tarts. She sold $\frac{3}{8}$ of the apple tarts and half of the strawberry tarts. She had 145 tarts left.

(a) How many pear tarts did she bake?

Ans: (a) _____ [2]

How many tarts did she sell altogether?

Ans: (b) _____ [2]

Do not
write in
this space

(Go on to the next page)

- 15 In the rectangle below, the area of triangle A is $\frac{1}{3}$ the area of the rectangle. The area of triangle B is $\frac{1}{4}$ the area of the rectangle. The area of triangle A is 5.85 cm^2 more than the area of triangle B.

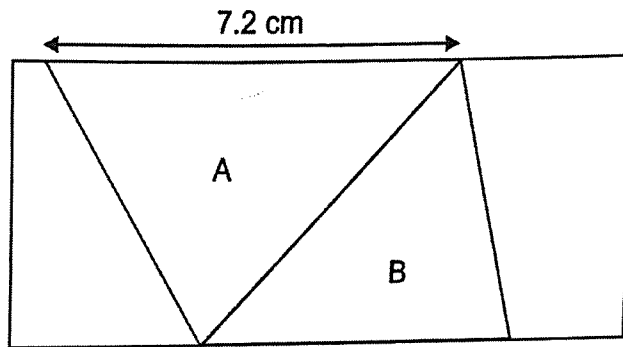

- (a) Find the area of the rectangle.

Ans: (a) _____ [1]

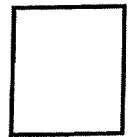

- (b) Find the perimeter of the rectangle.

Ans: (b) _____ [3]

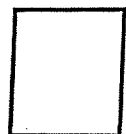

Do not
write in
this space

- 16 The wooden block as shown in Diagram A was dipped completely into a pail of paint.

Do not write in this space

Diagram A

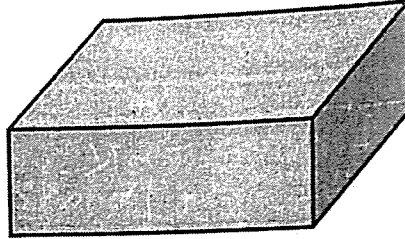

Then, it was cut along the dotted lines as shown in Diagram B to form the solid as shown in Diagram C. The solid formed could be divided into 6 identical cubes.

Diagram B

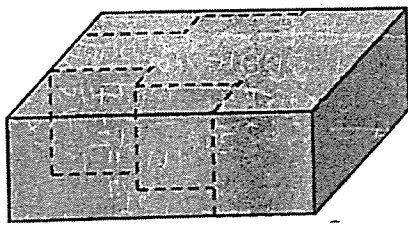
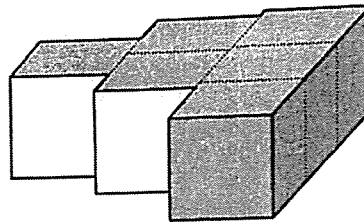

Diagram C



The total unpainted area of the solid in Diagram C was 337.5 cm^2 .

- (a) Find the volume of the wooden block at first.

Ans: (a) _____ [3]

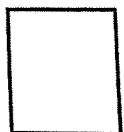

- (b) What percentage of the wooden block is the solid formed in Diagram C? Give your answer correct to 1 decimal place.

Do not
write in
this space

Ans: (b) _____ [2]

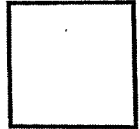

(Go on to the next page)

- 17 A deck of cards is numbered 1 to 50. Pamela draws 3 cards from it. The sum of the numbers on any of the 2 cards are 60, 28 and 58.

(a) Find the 3 numbers.

Do not
write in
this space

Ans: (a) _____ [3]

- (b) She draws a fourth card and the average of the 4 numbers is 20. What is the number on the fourth card?

Ans: (b) _____ [2]

END OF PAPER

SCHOOL : MGS PRIMARY SCHOOL
 LEVEL : PRIMARY 6
 SUBJECT : MATH
 TERM : 2022 SA2

PAPER 1 BOOKLET A

Q 1	Q2	Q3	Q4	Q5	Q6	Q7	Q8	Q9	Q10
2	2	4	2	4	3	1	4	4	3

Q 11	Q12	Q13	Q14	Q15
1	4	3	4	2

PAPER 1 BOOKLET B

Q16)	35 , 70 , 105
Q17)	$= 2.7 \div 9 \div 10$ $= 0.3 \div 10$ $= 0.03$
Q18)	$\frac{2}{3} + \frac{4}{7}$ $= \frac{14}{21} + \frac{12}{21}$ $= \frac{26}{21}$ $= 1 \frac{5}{21}$
Q19)	$9w = 8 \times 9$ $= 72$ $72 - 7 = 65$ $65 \div 5 = 13$
Q20)	Distance = speed x time $45 \text{ min} = \frac{3}{4} \text{ hour}$ $= 72 \times \frac{3}{4}$ $= 54 \text{ km}$

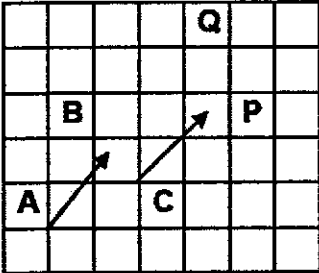
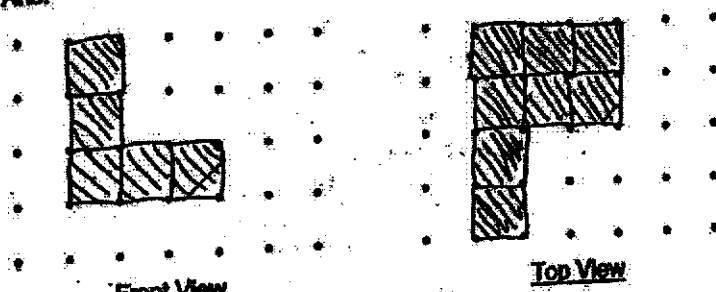
<p>Q21)</p>	 <p>a) Point P is south of point Q b) Point P is north-east of point C</p>
<p>Q22)</p>	<p>Total time = 135 minute First hour (60 minute) = \$6.00 Next 75 minute = \$2.50 x 3 = \$7.50</p> <p>Total = \$7.50 + \$6.00 = \$13.50</p>
<p>Q23)</p>	<p>$\angle GAC = 180^\circ - 128^\circ = 52^\circ$ $\angle FAD = 90^\circ - 52^\circ = 38^\circ$ $\angle BAD = 60^\circ - 38^\circ = 22^\circ$</p>
<p>Q24)</p>	<p>$1.5 \times 5 = 7.5$ litre = 7500 cm³ $30 \times 20 = 600$ $7500 + 600 = 12.5$ cm</p>
<p>Q25)</p>	<p>Ans:</p>  <p>Front View Top View</p>
<p>Q26)</p>	<p>$C - \frac{1}{2} \times 4u = 2u$ $B - \frac{1}{2} \times 2u = 1u$ $A - \frac{1}{2} \times 3u = 1.5u$ Shaded = $\frac{7}{16}$</p>

Q27) ** rose : orchid
 60% : 40%

$$\begin{array}{c} / \quad \backslash \\ 24 \quad 24 \end{array}$$

60% = 48
 10% = 48 ÷ 6 = 8
 40% = 4 x 8 = 32

Q28)

$$15u - 8u = 7u$$

$$7u = 259$$

$$1u = 259 \div 7$$

$$= 37$$

Li Min @ first = 8u
 8u = 37 x 8
 = 296

Kim **Li Min**

$$\frac{2}{5} \times 3 = \frac{6}{15}$$

$$\frac{3}{4} \times 2 = \frac{6}{8}$$

Q29) **Method 1**

<p>First week</p> <p>Sold : Unsold : Total</p> <p>1 : 2 : 3</p> <p>200 : 400 : 600</p> <p>8u = 400</p> <p>1u = 400 ÷ 8</p> <p>= 50</p> <p>5u = 5x50 = 250</p>	<p>2nd week</p> <p>Sold : Unsold : Total</p> <p>5 : 3 : 8</p> <p>250 : 150 : 400</p>
--	---

Q30)

Statement	True	False	Not possible to tell
(a) Jane is 15 cm shorter than Maya.			/
(b) The average height of the 5 girls is more than Jane's height but less than SiR's height.	/		
(c) The ratio of Jane's height to SiR's height is 1 : 2.		/	

--	--

PAPER 2

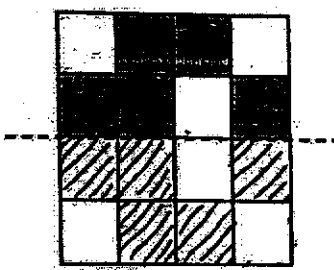
Q1)	$100g \rightarrow \$1.35$ $1g \rightarrow \$1.35 \div 100$ $= \$0.0135$ $3500g = \$0.0135 \times 3500$ $= \$47.25$
Q2)	$\angle FCB = 360^\circ - 90^\circ - 124^\circ$ $= 146^\circ$ $\angle BFC = (180^\circ - 146^\circ) \div 2$ $= 17^\circ$
Q3)	<i>shop W</i> $\$180 - \$50 = \$130$ (discounted Price) <i>shop Y</i> $100\% = \$180$ $25\% = \$180 \div 4 = \45 $\$180 - \$45 = \$135$ $\$135 - \$130 = \$5$
Q4)	Area of square = $24 \times 24 = 576$ Area of rectangle = $576 \div 30 = 19.2$ cm
Q5)	<p>a)</p>  <p>b)</p>

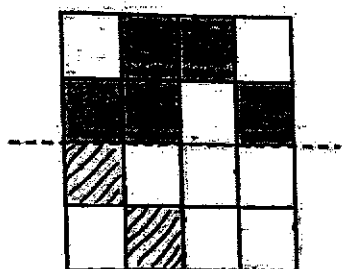

Q6)

a) Pen = \$p
 Notebook = \$(p+2)
 3 pen = \$3p
 2 notebooks = \$(2p+4)
 Total = \$(5p + 4)

b) 3 pens + 2 notebooks = \$22.50
 1 pen = \$p
 1 notebook = \$p+2
 $5p = \$22.50 - 4 = \18.50
 $1p = \$18.50 \div 5 = \3.70
 1 notebook = \$3.70 + 2 = \$5.70

Q7)

a) Week 3

b) $\frac{1}{4} = 520$

Amount of money she still needs to save = $1 - \frac{1}{4} = \frac{3}{4}$

$\frac{3}{4} = 520 \times 3 = \1560

Q8)

6. $12\text{km} = 6120\text{m}$

Time taken for Alex to complete path

$= D \div S = 6120 \div 340 = 18$

Alex = 18 minutes Ben = 450m behind

$6120 - 450 = 5670$ (*distance Ben travelled after 18 minutes*)

18 minutes = 5670m

Time = D \div S = 5670 \div 18 = 315m/minute

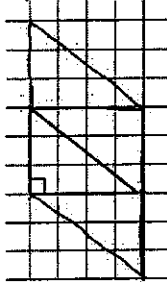
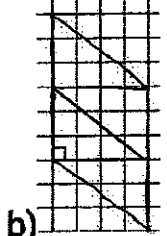
Q9)	<p>a)</p>   <p>b)</p>
Q10)	<p>a) $\angle SVP = (180^\circ - 32^\circ) \div 2 = 74^\circ$ $\angle WPV = 74^\circ - 35^\circ = 39^\circ$ $\angle TUS = \angle VUP = 180^\circ - 74^\circ - 39^\circ = 67^\circ$</p> <p>b) $\angle TWR = (360^\circ - 78^\circ - 78^\circ) \div 2 = 102^\circ$ $\angle PWQ = 180^\circ - 102^\circ = 78^\circ$ $\angle VWP = 180^\circ - 78^\circ = 102^\circ$ $\angle PVR = 180^\circ - 102^\circ - 39^\circ = 39^\circ$</p>
Q11)	<p>a) Basketball : cycling 3 : 2</p> <p>$3u = 150$ $1u = 150 \div 3$ $= 50$ $2u = 50 \times 2$ $= 100$</p> <p>b) $\text{Percentage decrease} = \frac{\text{percentage decrease}}{\text{original}} \times 100\%$ Badminton March = 175 April = 75 $175 - 75 = 100$ $\frac{100}{175} \times 100\% = 57.14\%$</p> <p>c) People who took part in swimming $= 25 + 200$ $= 225$ 225 people = \$528.75 Entrance Fee Per person = $\\$528.75 \div 225$ $= \\$2.35$</p>

Q12)	<p>a) $\frac{1}{2} \times \frac{22}{7} \times 14 = 22$ $\frac{1}{4} \times \frac{22}{7} \times 14 \times 2 = 22$ $14 + 22 + 22 + 14 + 22 + 22 = 116\text{cm}$</p> <p>b) <i>area of whole paper</i> = $28 \times 28 = 784$ <i>area of 2 semicircles</i> = $\frac{22}{7} \times 7 \times 7 = 154$ <i>area of semicircle</i> = $\frac{1}{2} \times \frac{22}{7} \times 7 \times 7 = 77$ $784 - (77 \times 2) - (154 \times 2) = 322 \text{ cm}^2$</p>
Q13)	<p><i>different in height</i> = $162 - 126 = 36$ <i>different in average</i> = $132.6 - 129.6 = 3$ <i>no of children in the group</i> = $36 \div 3 = 12$</p>
Q14)	<p>a) $4u + 6 + 5u + 20 + 8u = 145$ $17u = 145 - 26$ $= 119$ $1u = 119 \div 17$ $= 7$</p> <p>b) 67</p>
Q15)	<p>a) $1u = 5.85\text{cm}^2$ $? = 12u$ $12u = 5.85 \times 12$ $= 70.2 \text{ cm}^2$</p> <p>b) $8 \times 5.85 = 46.8$ $46.8 \div 7.2 = 6.5$ $70.2 \div 6.5 = 10.8$ $2 \times (10.8 + 6.5) = 34.6 \text{ cm}$</p>
Q16)	<p>a) $6 \text{ faces} = 337.5 \text{ cm}^2$ $1 \text{ face} = 337.5 \div 6 = 56.25 \text{ cm}^2$ $\text{Length} = \sqrt{56.25} = 7.5$ $\text{Vol of block} = (3 \times 7.5) \times (3 \times 7.5) \times 7.5 = 3796.875 \text{ cm}^3$</p> <p>b) $\frac{6}{9} \times 100\% = 66.7 \%$</p>
Q17)	<p>a) 13, 15, 45 b) $13 + 15 + 45 = 73$</p>

	$80 - 73 = 7$
--	---------------