

HENRY PARK PRIMARY SCHOOL
2022 PRELIMINARY EXAMINATION
MATHEMATICS
PRIMARY 6

PAPER 1
(BOOKLET A)

Name: _____ ()

Parent's Signature

Class: Primary 6 _____

Marks:

Paper 1	Booklet A	20
	Booklet B	25
Paper 2		55
Total		100

Total Time for Booklets A and B: 1 hour

Do not turn over this page until you are told to do so.

Follow all instructions carefully.

Answer all questions.

Shade your answers in the Optical Answer Sheet (OAS) provided.

You are **not** allowed to use a calculator.

Questions 1 to 10 carry 1 mark each. Questions 11 to 15 carry 2 marks each.
For each question, four options are given. One of them is the correct answer.
Make your choice (1, 2, 3 or 4) and shade your answer in the Optical Answer Sheet.

(20 marks)

1 The height of Mount Kraig is 350 000 m when rounded to the nearest thousand metres. Which of the following could be the actual height of Mount Kraig?

(1) 349 050 m

(2) 349 450 m

(3) 350 050 m

(4) 350 950 m

2 What is the value of $90 \div 4500$?

(1) 0.002

(2) 0.02

(3) 5

(4) 50

3 Arrange the following fractions from the largest to the smallest.

$$\frac{2}{11}, \frac{3}{10}, \frac{1}{5}$$

(1) $\frac{1}{5}, \frac{2}{11}, \frac{3}{10}$

(2) $\frac{2}{11}, \frac{1}{5}, \frac{3}{10}$

(3) $\frac{3}{10}, \frac{2}{11}, \frac{1}{5}$

(4) $\frac{3}{10}, \frac{1}{5}, \frac{2}{11}$

4 Express 4080 g in kg.

- (1) 4.008 kg
- (2) 4.08 kg
- (3) 40.08 kg
- (4) 40.8 kg

5 A cuboid of height 5 cm has a square base of side 4 cm. What is its volume?

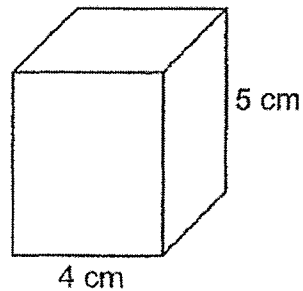

- (1) 20 cm^3
- (2) 80 cm^3
- (3) 100 cm^3
- (4) 125 cm^3

6 Mrs Ling was in school at 6.40 a.m. yesterday. She stayed in school for 9 hours and 40 minutes. What time did she leave the school yesterday?

- (1) 15 40
- (2) 15 20
- (3) 16 20
- (4) 16 40

7 Given that AC is the base of the triangle ABC, what is the height of the triangle?

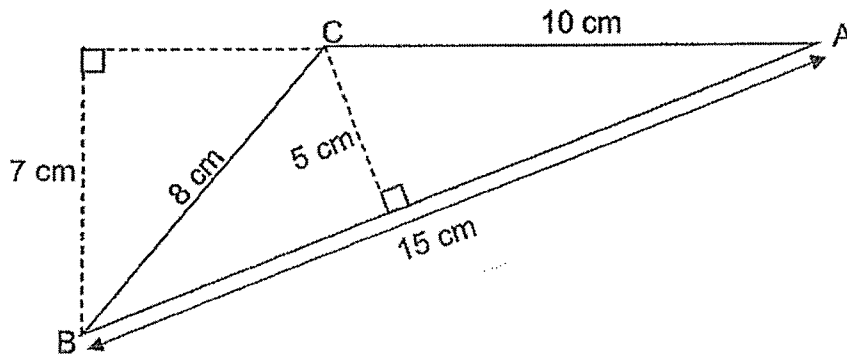

- (1) 5 cm
- (2) 7 cm
- (3) 8 cm
- (4) 15 cm

8 Express 0.003 as a percentage.

- (1) 0.03%
- (2) 0.3%
- (3) 3%
- (4) 30%

9 The figure below shows a pyramid.

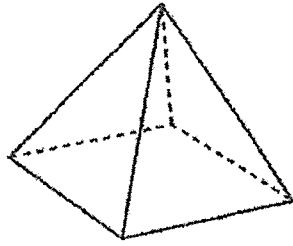

Which of the following is **not** a net of the pyramid?

(1)

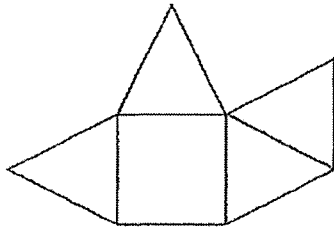

(2)

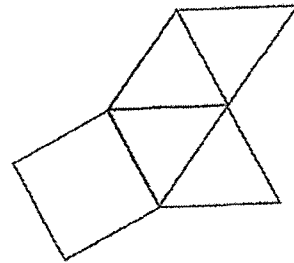

(3)

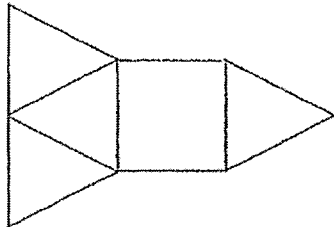

(4)

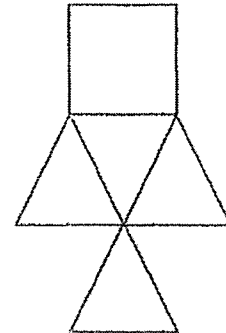

Use the information below to answer questions 10 and 11.

The pie chart below shows the number of different coloured pens a bookshop sold. $\frac{1}{3}$ of the pens sold were green. $\frac{1}{4}$ of the pens sold were either purple or red and the rest were blue. The bookshop sold 4 times as many purple pens as red pens.

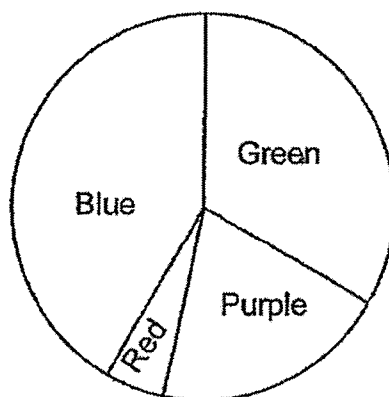

10 What fraction of the pens sold were blue?

- (1) $\frac{1}{3}$
- (2) $\frac{5}{12}$
- (3) $\frac{11}{30}$
- (4) $\frac{17}{48}$

11 Given that the shop sold 20 green pens, how many red pens did it sell?

- (1) 12
- (2) 15
- (3) 3
- (4) 25

- 12 Bryan kept his black and white caps in two boxes. The number of black caps and white caps in the first box was in the ratio 2 : 1. The number of black caps and white caps in the second box was in the ratio 5 : 7. The two boxes had the same number of caps. What fraction of Bryan's caps were white?

- (1) $\frac{1}{3}$
(2) $\frac{7}{12}$
(3) $\frac{8}{15}$
(4) $\frac{11}{24}$

- 13 WXYZ is a parallelogram. Find $\angle XYV$.

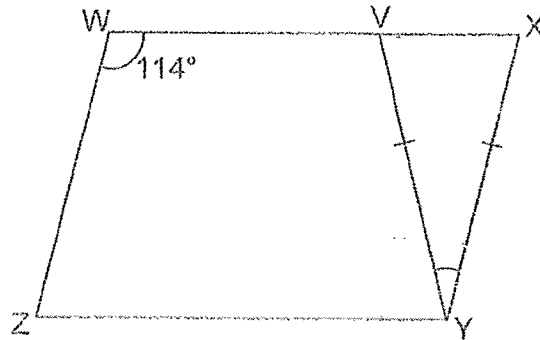

- (1) 57°
(2) 66°
(3) 48°
(4) 33°

- 14 Zi Xuan used identical black and white squares to form a symmetrical pattern on a large square board. The figure below shows part of the square board.

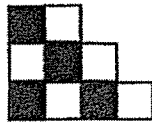

Which of the following pieces will complete the pattern on the square board?

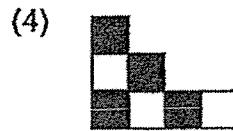
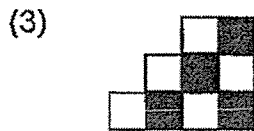
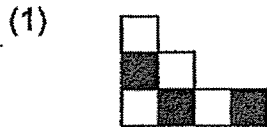

- 15 Joan, Siti and Xiuli had 60 beads each. Joan gave $\frac{2}{5}$ of her beads to Xiuli. Siti gave some of her beads to Xiuli. Xiuli had 3 times the total of the remaining beads Joan and Siti had. How many beads did Siti give Xiuli?

- (1) 20
 (2) 24
 (3) 51
 (4) 75

(Go on to BOOKLET B)

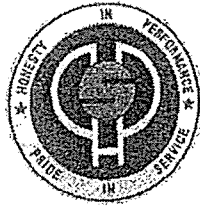

HENRY PARK PRIMARY SCHOOL
2022 PRELIMINARY EXAMINATION
MATHEMATICS
PRIMARY 6

PAPER 1
(BOOKLET B)

Name: _____ ()

Class: Primary 6 _____

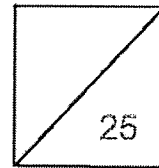

Total Time for Booklets A and B: 1 hour

Do not turn over this page until you are told to do so.

Follow all instructions carefully.

Answer all questions.

Write your answers in this booklet.

You are **not** allowed to use a calculator.

Questions 16 to 20 carry 1 mark each. Write your answers in the spaces provided. For questions which require units, give your answers in the units stated.

Do not write in this space

(5 marks)

16 Each of the four cards shown below represents a 1-digit number.



The sum of all the digits of the four cards is a multiple of 8. What is the missing digit in the card shown above?

Ans: _____

17



Usual price: 95¢ per apple

SPECIAL OFFER:

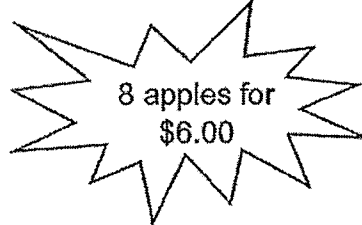

Mrs Tan bought 8 apples during the special offer. Without the special offer, how much more would she have to pay for the 8 apples?

Ans: \$ _____

18 $3 : 12 = \boxed{?} : 16$

What is the missing number in the box?

Ans: _____

- 19 The semicircle below has a diameter of 40 cm. What is the area of the semicircle? Take $\pi = 3,14$

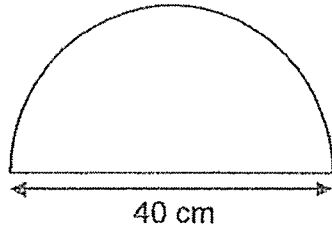

Do not write
in this space

Ans: _____ cm²

- 20 The square grid below shows the positions of points A, B, C, D and E.

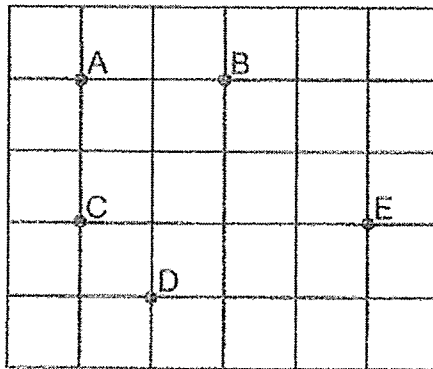

Point (a) is south-west of point (b).

Ans: (a) _____

(b) _____

Questions 21 to 30 carry 2 marks each. Show your working clearly and write your answers in the spaces provided. For questions which require units, give your answers in the units stated.

Do not write in this space

(20 marks)

21 In the square grid below, AB and BC are straight lines.

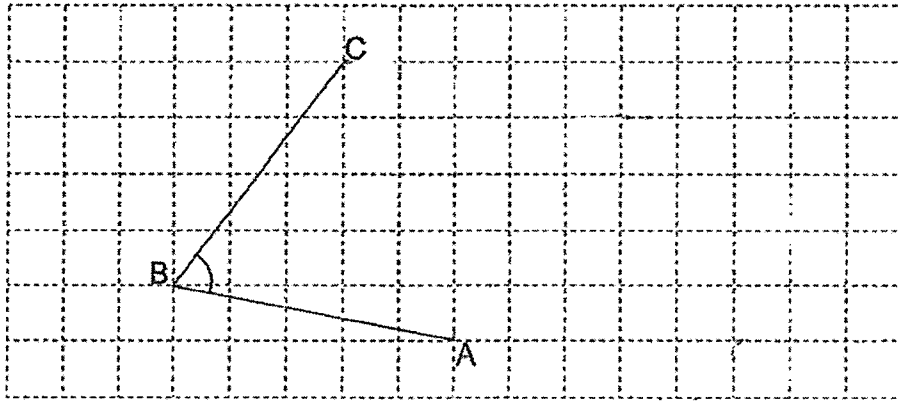

- (a) Measure and write down the size of $\angle ABC$.
- (b) AB and BC form two sides of a parallelogram ABCD. Complete the drawing of the parallelogram ABCD within the grid and label point D. [1]

Ans: (a) _____ ° [1]

22 The figure shows a rectangular box partly filled with 1-cm cubes. What is the volume of the rectangular box?

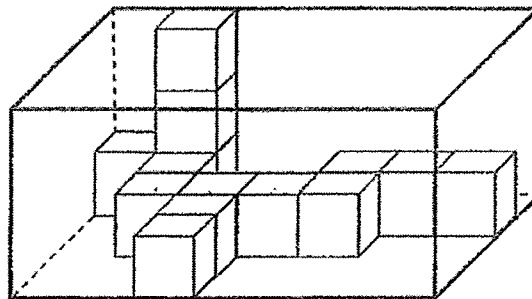

Ans: _____ cm^3

- 23 Jacky had some stickers. He gave $\frac{1}{6}$ of the stickers each to his two sisters. He put aside $\frac{2}{3}$ of his remaining stickers to be shared equally among his brothers. Each of his brothers received $\frac{1}{9}$ of the stickers. How many brothers did Jacky have?

Do not write
in this space

Ans: _____

- 24 What is the percentage discount for the shirt shown?

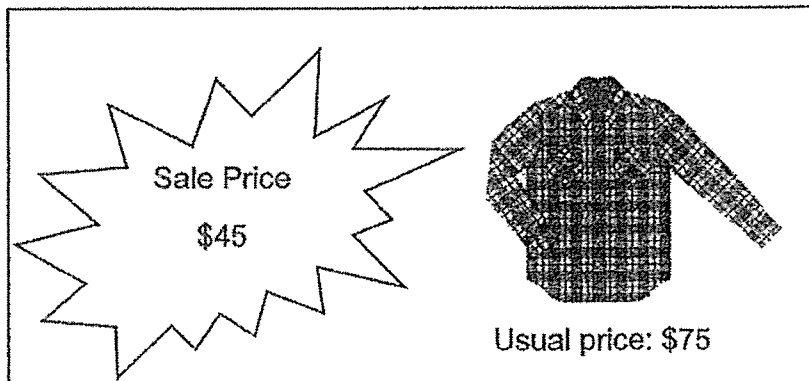

The diagram is enclosed in a rectangular border. On the left, there is a jagged, starburst-shaped callout box containing the text "Sale Price" and "\$45". To the right of this callout is a line drawing of a long-sleeved, button-down shirt. Below the shirt, the text "Usual price: \$75" is written.

Ans: _____ %

- 25 Mr Lee drove for 6 hours from City A to City B. In the first two hours, he drove at an average speed of 75 km/h. For the rest of the journey, he drove at an average speed of 60 km/h. What was his average speed for the whole journey?

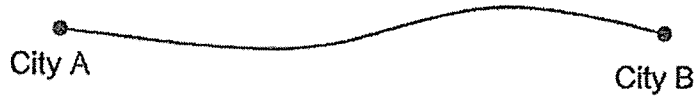

Do not write
in this space

Ans: _____ km/h

- 26 John had $24k$ marbles. Kelvin had 16 fewer marbles than John while Mike had half as many marbles as John. How many marbles do the 3 boys have in total? Give your answer in terms of k in the simplest form.

Ans: _____

- 27 The figure below is made up of a quarter circle and an equilateral triangle. Find the perimeter of the figure. Take $\pi = \frac{22}{7}$

Do not write in this space

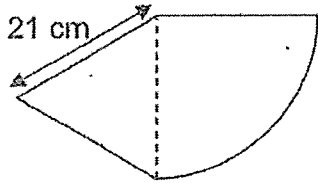

Ans: _____ cm

- 28 A pyramid and its net are shown below. The base of the pyramid in both diagrams are shaded. Find the perimeter of the net of the pyramid.

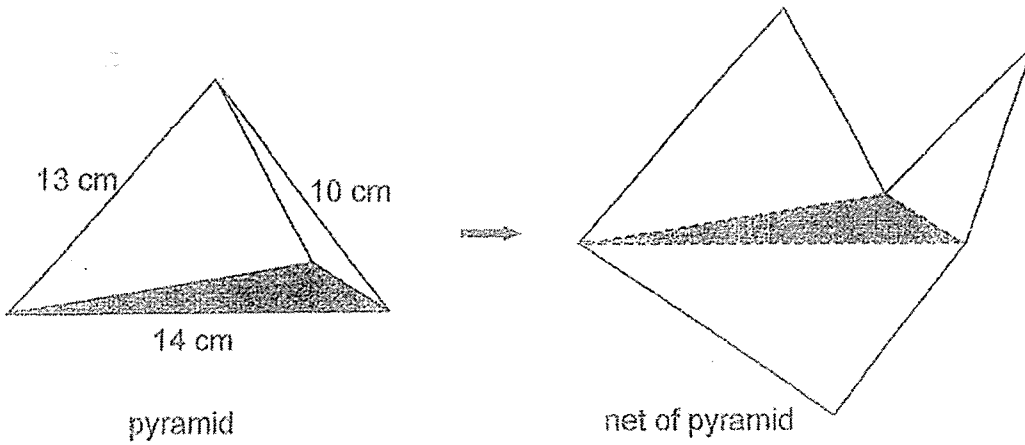

Ans: _____ cm

- 29 The table below shows the different amounts of money donated by a group of students. Part of the table is covered by an ink blot. $\frac{3}{4}$ of the group of students donated at least \$5.

Do not write in this space

Amount of money donated	\$0	\$2	\$5	\$8	\$10
Number of students	35	28	38		

Each statement below is either true, false or not possible to tell from the information given. For each statement, put a tick (✓) in the correct column.

Statement	True	False	Not possible to tell
Every student in the group donated some money.			
The group consisted of 252 students.			
The number of students who donated \$10 was the greatest.			

30

The figure below is made up of triangles WXY and ABX. The total unshaded area of the figure is 180 cm^2 . Find the shaded area BXZ.

Do not write in this space

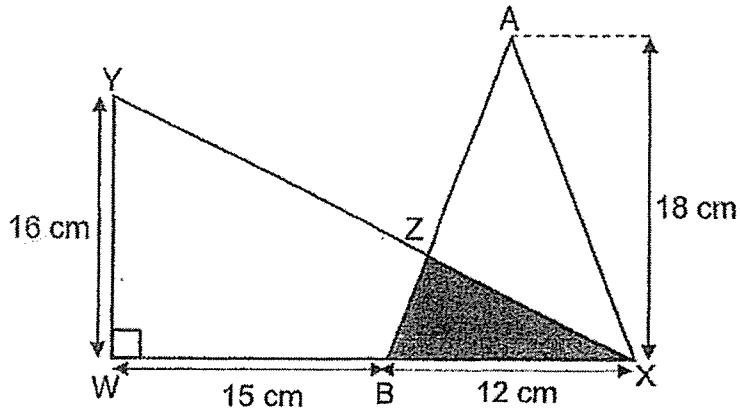

Ans: _____ cm^2

End of Paper



HENRY PARK PRIMARY SCHOOL
2022 PRELIMINARY EXAMINATION
MATHEMATICS
PRIMARY 6

PAPER 2

Parent's Signature

Name: _____ ()

Class: Primary 6 _____

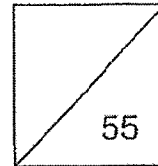

Time for Paper 2: 1 hour 30 minutes

Do not turn over this page until you are told to do so.

Follow all instructions carefully.

Answer all questions.

Show your working clearly as marks are awarded for correct working.

Write your answers in this booklet.

You are allowed to use a calculator.

Questions 1 to 5 carry 2 marks each. Show your working clearly and write your answers in the spaces provided. For questions which require units, give your answers in the units stated.

(10 marks)

- 1 Ahmad had a sum of money. He could only buy 10 notebooks with all the money he had. He decided to buy 6 notebooks and 4 pens. He had \$2.40 left. Each pen cost \$0.80. How much money did Ahmad have at first?

Ans: \$ _____

- 2 The bar graph below shows the amount of money ABC clothing store earned from Monday to Thursday.

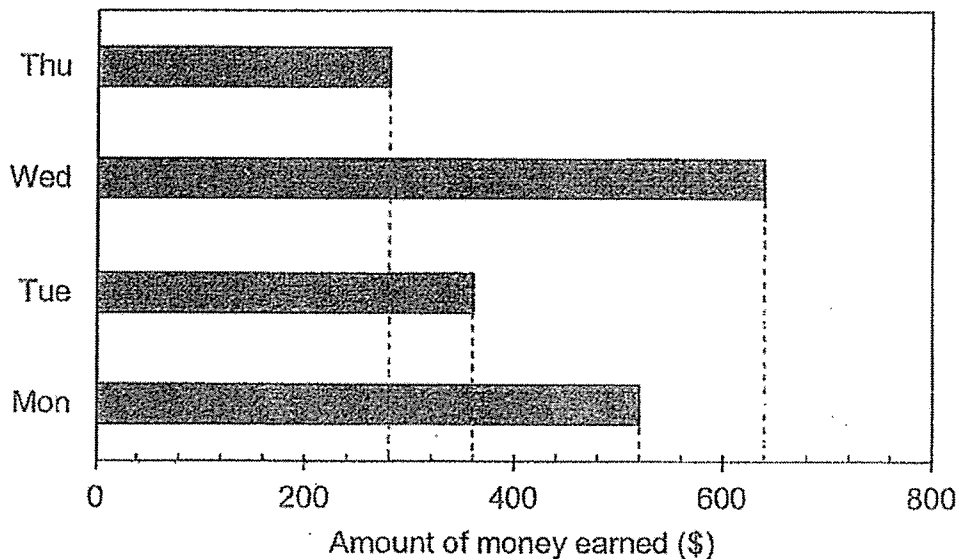

What is the average amount of money ABC clothing store earned from Monday to Thursday?

Ans: \$ _____

Please do not write in the margin.

- 3 The figure below shows a right-angled triangle and a semicircle of radius 14 cm. Use the calculator value of π to find the perimeter of the figure. Round your answer to 2 decimal places.

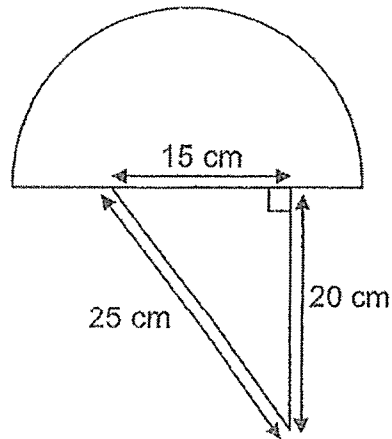

Ans: _____ cm

- 4 PQRS is a square. STR is an equilateral triangle. Find the value of $\angle QPT$.

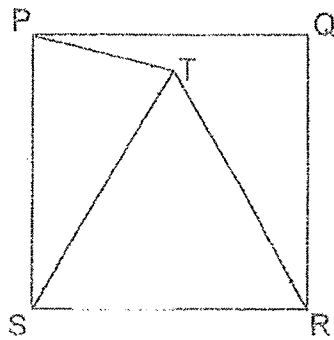

Ans: _____^o

Please do not write in the margin.

- 5 In the figure below, $UVWX$ is a parallelogram and XYZ is an isosceles triangle where $XY = XZ$. UXY and WXZ are straight lines and the sum of $\angle YZX$ and $\angle XWV$ is 147° . Find $\angle UVW$.

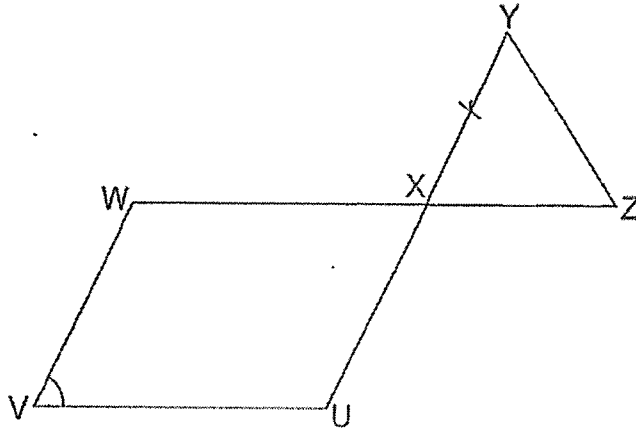

Ans: _____^o

For questions 6 to 17, show your working clearly and write your answers in the spaces provided. The number of marks available is shown in the brackets [] at the end of each question or part-question.

(45 marks)

- 6 Jane and Siti had a number of beads. Jane had 432 more beads than Siti. After Jane gave away $\frac{1}{4}$ of her beads and Siti gave away $\frac{5}{8}$ of her beads, Jane had 441 more beads than Siti. How many beads did Jane have at first?

Ans: _____ [3]

- 7 At a paint shop, there were some identical containers. 70% of the containers were completely filled with paint. The remaining 120 containers were empty. The total volume of paint in the containers was 1400 l. What was the volume of paint in one container? Give your answer in litres.

Ans: _____ [3]

- 8 Jen and Grace took part in a race and both of them started running from the same point at the same time. After 35 min, Jen completed the race, but Grace had only run $\frac{5}{7}$ of the distance. Given that both girls did not change their speeds throughout the race and that Jen ran at a constant speed of 36 m/min faster than Grace, find Grace's average speed for the first 35 min.

Ans: _____ [3]

- 9 The table below shows the number of plastic bottles collected by four classes for recycling.

Class	Number of plastic bottles
6A	11
6B	$8m$
6C	$40 - 3m$
6D	?

- (a) Find the total number of plastic bottles 6A, 6B and 6C collected. Express your answer in terms of m in the simplest form.

Ans: (a) _____ [1]

- (b) The total number of plastic bottles collected by the four classes is 209. Given $m = 13$, find the number of plastic bottles collected by 6D.

Ans: (b) _____ [2]

- 10 The pie chart below shows the number of \$10, \$20, \$50 and \$100-tickets sold by a concert organiser. $\frac{1}{2}$ of the number of tickets sold were \$10-tickets. $\frac{3}{10}$ of the number of tickets sold were \$20-tickets.

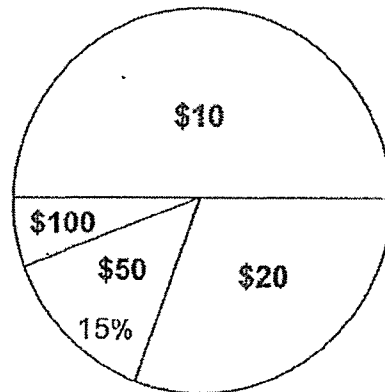

- (a) What fraction of the tickets sold were \$100-tickets?
Express your answer in the simplest form.

Ans: (a) _____ [1]

- (b) A total of \$10 810 was collected from the sale of all the tickets.
How much was collected from the sale of \$10-tickets?

Ans: (b) _____ [3]

- 11 A money box contained some money at first. A took $\frac{1}{2}$ the amount of money and another \$1500 from the box. After that, B took $\frac{1}{4}$ of the remaining amount of money and another \$850 from the box. In the end, C took the rest of the money left in the box. Given that C took \$1400, find the amount of money in the box at first.

Ans: _____ [4]

- 12 Sam wanted to fill an empty tank measuring 125 cm long and 80 cm wide with water. He turned on Tap A first and after 3 minutes, he turned on Tap B. Both taps were turned off at the same time when the tank was filled to the brim without overflowing.

The line graph shows the amount of water in the tank over 10 minutes.

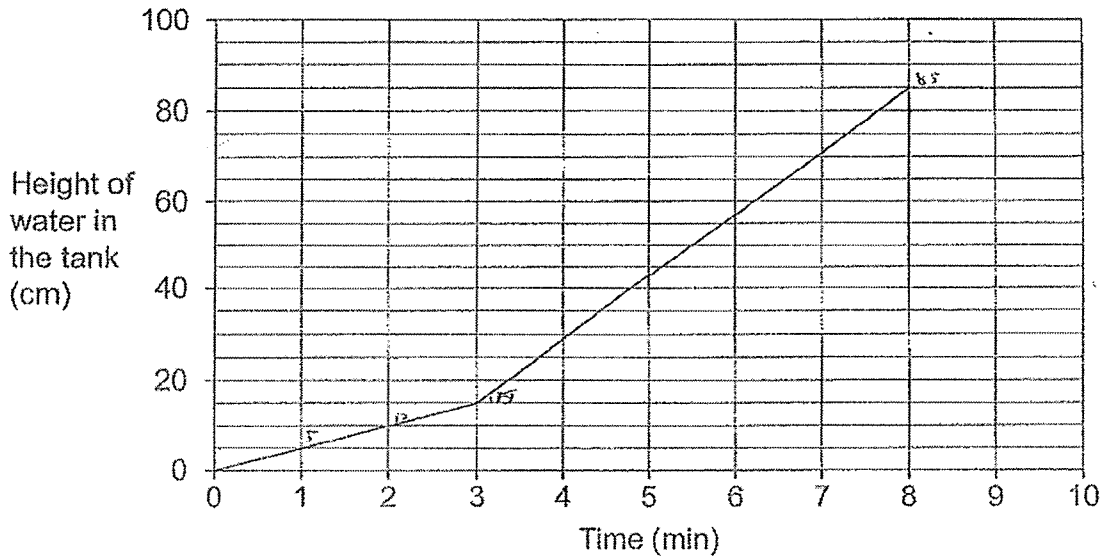

- (a) Find the volume of the tank.

Ans: (a) _____ [1]

- (b) In one minute, how many litres of water flowed from Tap B?

Ans: (b) _____ [3]

- 13 Last year, the ratio of the number of men to the number of women who signed up for a marathon was 5 : 4. This year, the number of men who signed up for the marathon increased by 30% and the number of women who signed up for the marathon decreased by 50%. A total of 4913 men and women signed up for the marathon this year. What is difference between the total number of people who signed up for the marathon in the two years?

Ans: _____ [3]

Please do not write in the margin.

- 14 Two tanks, A and B, are shown below. Tank A was filled to the brim with water. Water was transferred from Tank A to Tank B until the height of the water level in both tanks are the same. What is the new height of water level in each tank?

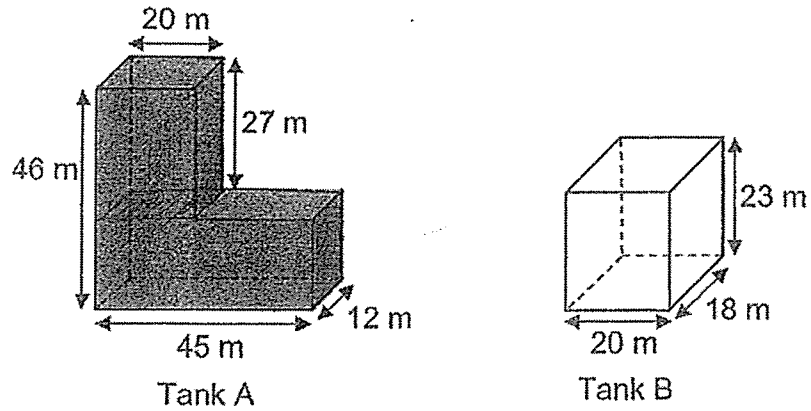

Ans: _____ [3]

15

The figure below shows a rectangle with 4 identical three-quarter circles. The length and breadth of the rectangle is in the ratio 13 : 10. Taking $\pi = 3.14$,

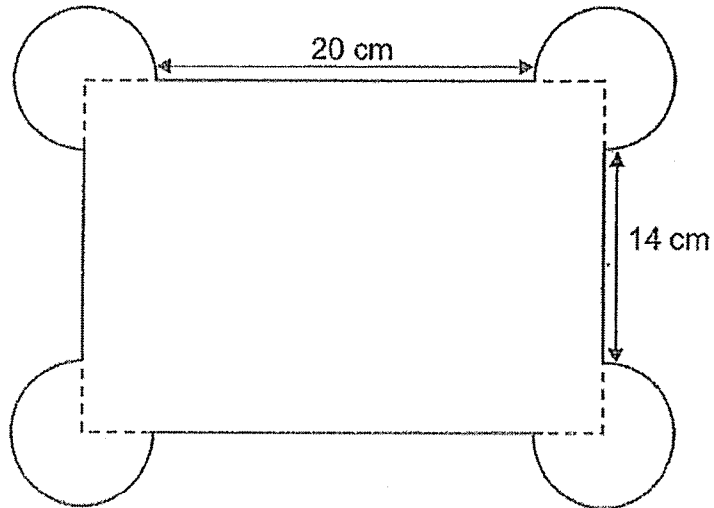

(a) find the perimeter of the figure.

Ans: (a) _____ [3]

(b) find area of the figure.

Ans: (b) _____ [2]

Please do not write in the margin.

- 16 (a) The figure below shows angles at a point O. Without using a protractor, draw another angle at O which is the same size as $\angle x$ in the figure below. Label the angle as y. [1]

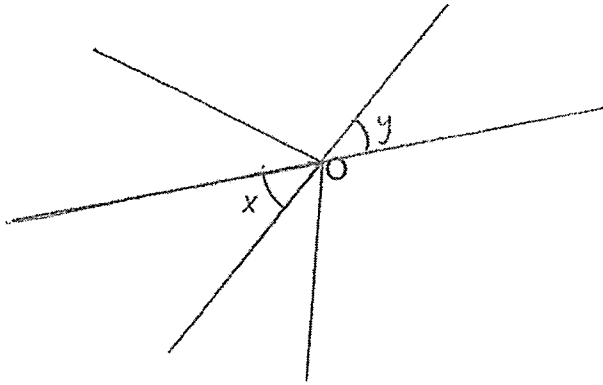

- (b) ABCD is a square and DEFG is a trapezium. AG and DH are straight lines. DG is parallel to EF.

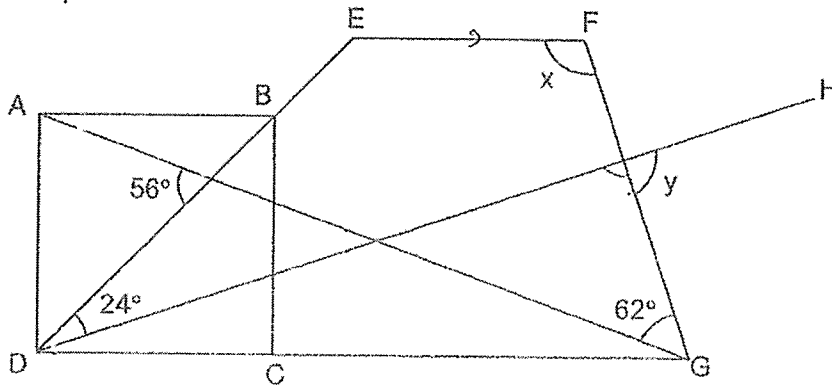

- (i) Find $\angle x$.

Ans: (ii) _____ [2]

- 17 Jamina uses circles and triangles to form figures that follow a pattern as shown below.

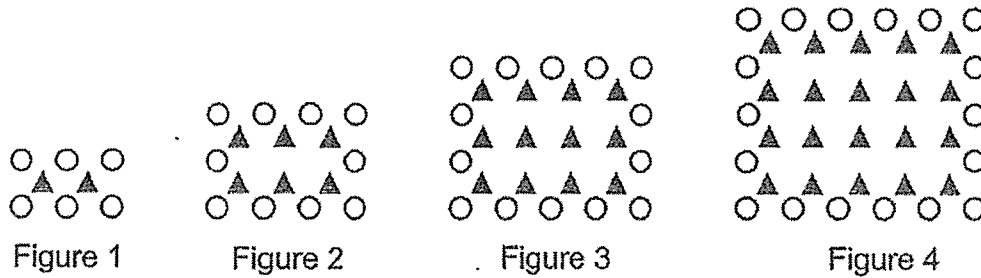

- (a) The table shows the number of triangles and circles for the first 4 figures. Complete the table for Figure 5. [1]

Figure Number	1	2	3	4	5
Number of triangles	2	6	12	20	
Number of circles	6	10	14	18	
Total number of triangles and circles	8	16	26	38	

- (b) A figure in the pattern has 240 triangles. What is the Figure Number?

Ans: (b) _____ [2]

- (c) What is the total number of triangles and circles in Figure 100?

Ans: (c) _____ [2]

End of Paper
Please do not write in the margin.

SCHOOL : HENRY PARK SCHOOL
 LEVEL : PRIMARY 6
 SUBJECT : MATH
 TERM : 2022 PRELIM

PAPER 1 BOOKLET A

3	2	4	2	2	3	2	2	1	2
---	---	---	---	---	---	---	---	---	---

3	4	3	4	3
---	---	---	---	---

PAPER 1 BOOKLET B

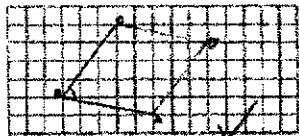
Q16) 2									
Q17) \$1.60									
Q18) 4									
Q19) 628									
Q20) a)C b)B									
Q21) 									
Q22) 105cm ³									
Q23) 4									
Q24) 40%									
Q25) 65 km/h									
Q26) 60k - 16									
Q27) 96cm									
Q28) 66cm									
Q29) <table border="1" data-bbox="331 1818 1375 1930" style="margin-left: auto; margin-right: auto;"> <tr> <td style="width: 33%;"></td> <td style="width: 33%;"></td> <td style="width: 33%;"></td> </tr> <tr> <td style="text-align: center;">_____</td> <td style="text-align: center;">_____</td> <td style="text-align: center;">_____</td> </tr> <tr> <td style="text-align: center;">_____</td> <td style="text-align: center;">_____</td> <td style="text-align: center;">_____</td> </tr> </table>				_____	_____	_____	_____	_____	_____
_____	_____	_____							
_____	_____	_____							

Q30) 72 cm ²

PAPER 2

Q1) \$14
Q2) \$450
Q3) 101.98cm
Q4) 15°
Q5) 82°
Q6) 744
Q7) 5
Q8) 90
Q9) a)51 + 5m b)93
Q10) a)1/20 b)\$2300
Q11) \$9000
Q12) a)850 000cm ³ b)90L
Q13) 289
Q14) 18.6 cm
Q15) a)124.52 cm b)604.78cm ²
Q16) a)  b)i) 107° ii)94°
Q17) a)30 / 22 / 52 b)15 c)10502