

AT / GAL / WSW / EL / LYL

Index
No.

--	--	--	--	--	--	--

SINGAPORE CHINESE GIRLS' SCHOOL

PRELIMINARY EXAMINATION 2021

PRIMARY 6

MATHEMATICS
PAPER 1

BOOKLET A

Name : _____ ()

17 August 2021

Class : Primary 6 SY / C / G / SE / P

		Marks attained	Max Mark	Parent's Signature
Paper 1	Booklet A		20	
	Booklet B		25	
Paper 2			55	
Total Marks			100	

15 Questions
20 Marks

Total Time for Booklets A and B: 1 h

INSTRUCTIONS TO CANDIDATES

Do not open this booklet until you are told to do so.

Follow all instructions carefully.

Answer all questions.

You are **not allowed** to use a calculator

Booklet A

Questions 1 to 10 carry 1 mark each. Questions 11 to 15 carry 2 marks each.
For each question, four options are given. One of them is the correct answer.
Make your choice (1, 2, 3 or 4). Shade the correct oval (1, 2, 3 or 4) on the Optical Answer Sheet. (20 marks)

1. The mass of a basketball is approximately _____.
 - (1) 25 g
 - (2) 2.5 kg
 - (3) 6900g
 - (4) 0.69 kg

2. Find the value of $2.4 \div 60$.
 - (1) 0.004
 - (2) 0.04
 - (3) 0.4
 - (4) 4

3. Which of the following, when rounded off to the nearest tenth, is 60.3?
 - (1) 59.32
 - (2) 59.93
 - (3) 60.26
 - (4) 60.36

4. How many factors of 36 are multiples of 4?
 - (1) 8
 - (2) 2
 - (3) 3
 - (4) 4

5. Arrange the following distances in descending order:

4.30 km , $4\frac{1}{3} \text{ km}$, $4 \text{ km } 103 \text{ m}$

- (1) $4\frac{1}{3} \text{ km}$, 4.30 km , $4 \text{ km } 103 \text{ m}$
(2) 4.30 km , $4\frac{1}{3} \text{ km}$, $4 \text{ km } 103 \text{ m}$
(3) $4 \text{ km } 103 \text{ m}$, $4\frac{1}{3} \text{ km}$, 4.30 km
(4) $4 \text{ km } 103 \text{ m}$, 4.30 km , $4\frac{1}{3} \text{ km}$

6. What is the approximate length of the paper clip below?

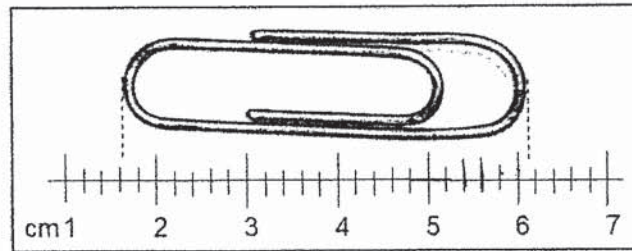

- (1) 4.25 cm
(2) 4.5 cm
(3) 4.8 cm
(4) 6.1 cm
7. The ratio of the number of girls to boys in a class is 4 : 5. Half of the girls in the class had long hair. What is the ratio of the number of girls with long hair to the number of students in class?
- (1) 1 : 4
(2) 1 : 9
(3) 2 : 5
(4) 2 : 9

8. In the figure below, 3 cubes weighed the same as 5 balls. What is the average mass of each object if the mass of a cube is 80g?

- (1) 10 g
 (2) 30 g
 (3) 48 g
 (4) 60 g

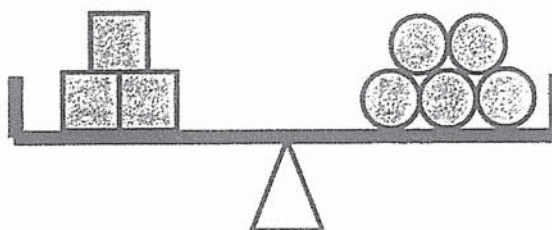

9. What is the value of $5 + \frac{10y}{4} - y + 2$ when $y = 4$?

- (1) 9
 (2) 11
 (3) 12
 (4) 13

10. The figure ABCD is a rectangle. Which angle is the same as $\angle ABD$?

- (1) $\angle ADE$
 (2) $\angle BDG$
 (3) $\angle CBD$
 (4) $\angle CFG$

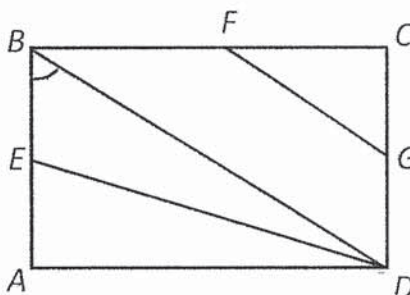

11. Auntie May had a roll of ribbon, 2m in length. She used 40 cm to wrap a present and cut the remaining into h pieces. How long is each piece?

- (1) $\frac{240}{h}$ cm
 (2) $\frac{200-40}{h}$ cm
 (3) $(\frac{200}{40} \div h)$ cm
 (4) $(200 - \frac{40}{h})$ cm

12. The bar graph shows the different ways students travel to school. What fraction of the students take the MRT to school?

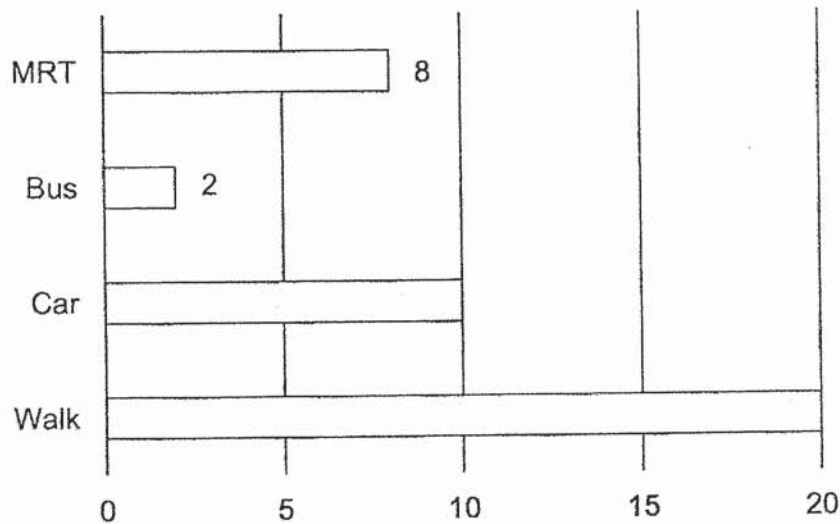

- (1) $\frac{1}{5}$
- (2) $\frac{2}{5}$
- (3) $\frac{1}{4}$
- (4) $\frac{4}{5}$
13. 10 girls and 5 boys lined up in a row. There were no boys standing next to each other. Between every two boys, there were 2 girls. The distance between two girls was 50 cm apart while the distance between a girl and a boy is 100 cm. How long was the line formed by the children?
- (1) 600 cm
- (2) 750 cm
- (3) 1000 cm
- (4) 1150 cm

14. The figure below, not drawn to scale, $\angle f$ is twice the sum of $\angle b$ and $\angle d$. Find the sum of $\angle a + \angle b + \angle c + \angle d + \angle e$.

- (1) 240°
 (2) 270°
 (3) 300°
 (4) 360°

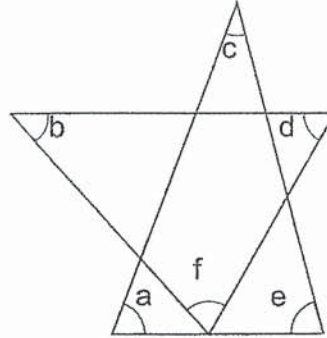

15. A table with 4 columns is filled with numbers in a certain pattern. The first 4 rows are shown in the table below.

	Column A	Column B	Column C	Column D
Row 1	0	1	2	3
Row 2	7	6	5	4
Row 3	8	9	10	11
Row 4	15	14	13	12
\vdots	\vdots	\vdots	\vdots	\vdots

In which column will the number 487 appear?

- (1) Column A
 (2) Column B
 (3) Column C
 (4) Column D

End of Booklet A

AT / GAL / WSW / EL / LYL

Index
No.

						-	
--	--	--	--	--	--	---	--

SINGAPORE CHINESE GIRLS' SCHOOL

PRELIMINARY EXAMINATION 2021

PRIMARY 6

MATHEMATICS
PAPER 1

BOOKLET B

Name : _____ ()

17 August 2021

Class : Primary 6 SY / C / G / SE / P

Paper 1	Mark attained	Max Mark
Booklet B		25

15 Questions
25 Marks

Total Time for Booklets A and B: 1 h

INSTRUCTIONS TO CANDIDATES

Do not open this booklet until you are told to do so.

Follow all instructions carefully.

Answer all questions.

You are **not allowed** to use a calculator

Booklet B

Questions 16 to 20 carry 1 mark each. Write your answers in the spaces provided. For questions which require units, give your answers in the units stated. **(5 marks)**

Do not write in
this column

16. Find the value of $3.06 - 1.2$.

Ans: _____

17. Express $3\frac{5}{8}$ as a decimal, rounded off to 2 decimal places.

Ans: _____

18. Nadine bought a mug that cost \$20 before GST. What is the amount she had to pay after adding 7% GST?

Ans: \$ _____

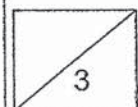

19. 5 years ago, William's father was 7 times as old as he was. William is 10 years old now. How old is William's father now?

Do not write in
this column

Ans: _____

20. If $99 \times 9 = h$, find 99×99 in terms of h .

Ans: _____

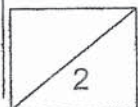

Questions 21 to 30 carry 2 marks each. Show your working clearly and write your answers in the spaces provided. For questions which require units, give your answers in the units stated. **(20 marks)**

Do not write in this column

21. Jimmy saved \$1.50 every day. Nora saved \$0.50 more than Jimmy each day. How much money did they save altogether after 3 days?

Ans: \$ _____

22. The rectangular tank below is filled with 11 cubic blocks. How many more cubic blocks is needed to fill the tank completely?

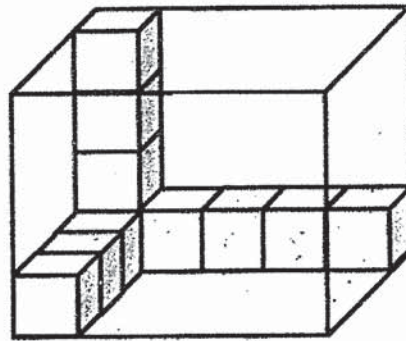

Ans: _____

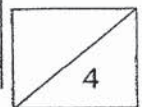

23. Peter and John were reading the same book. Peter started on Monday and read 10 pages each day. John started reading on Wednesday and they both completed reading the book on Sunday. Given that John read the same number of pages each day, how many pages did John read each day?

Do not write in this column

Ans: _____

24. Two identical parallelograms overlapped as shown below. Find $\angle a$.

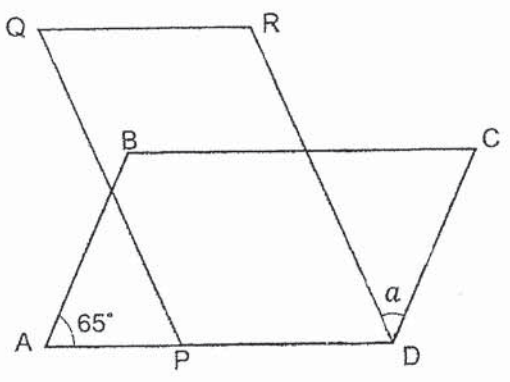

Ans: _____

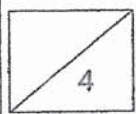

25. Bala had just enough money to buy either 12 erasers or 3 pens. He bought a pen and wanted to spend the rest of his money on erasers. How many erasers can he buy?

Do not write in this column

Ans: _____

26. The figure below shows two rectangles, ABCD and BEFD, overlapping. Find the area of the shaded part.

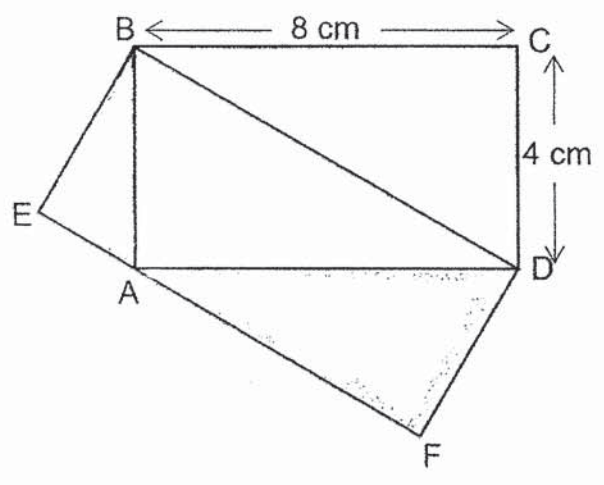

Ans: _____ cm²

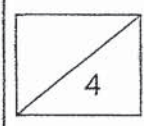

27. Mr Wong bought 3 2 l-bottled drinks for a party. He poured $\frac{1}{8}$ l of drinks into each cup. How many cups can Mr Wong fill?

Do not write in this column

Ans: _____

28. The figure below shows a square of side 60cm and 2 quadrants overlapping. Find the perimeter of the shaded part. Leave your answer in π .

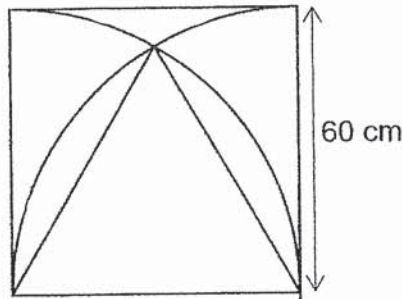

Ans: _____ cm

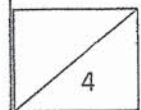

29. The graph below shows the number of chicken nuggets a group of children ate at a party. How many chicken nuggets did the children eat altogether?

Do not write in this column

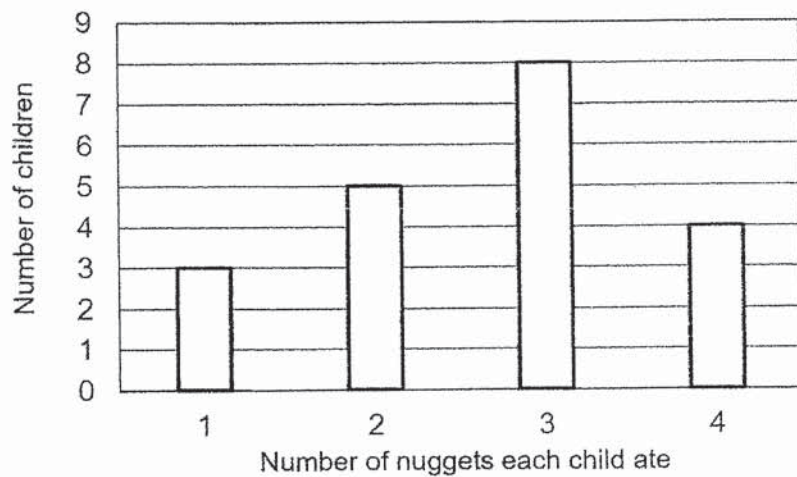

Ans: _____

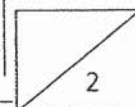

30. The figure ABCD, not drawn to scale, consists of 4 identical isosceles triangles.

Do not write in this column

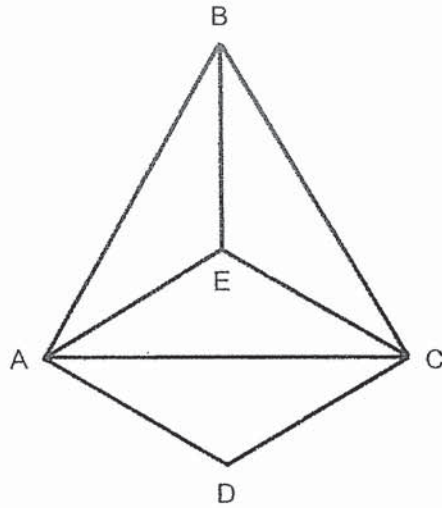

Each of the statements below is either true, false or not possible to tell from the information given. For each statement, put a tick ✓ to indicate your answer.

Statement	True	False	Not possible to tell
a) $\angle ADC$ is 90°			
b) Triangle ABC is an equilateral triangle.			

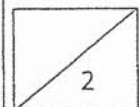

End of Booklet B

AT / GAL / WSW / EL / LYL

Index
No.

						-	
--	--	--	--	--	--	---	--

SINGAPORE CHINESE GIRLS' SCHOOL

PRELIMINARY EXAMINATION 2021

PRIMARY 6

MATHEMATICS

PAPER 2

Name : _____ ()

17 August 2021

Class : Primary 6 SY / C / G / SE / P

	Mark	Max Mark
Paper 2		55

Parent's Signature

17 Questions
55 Marks

Total Time for Paper 2: 1 h 30 min

INSTRUCTIONS TO CANDIDATES

Do not open this booklet until you are told to do so.

Follow all instructions carefully.

Answer all questions.

You **are allowed** to use the calculator

Questions 1 to 5 carry 2 marks each. Show your working clearly in the space below each question and write your answers in the space provided. For questions which require units, give your answers in the units stated. (10 marks)

Do not write in this column

1. At a sale, mugs were sold at \$1.90 each and a free mug was given for every 2 mugs purchased. How much must Benny pay if he needed to get 15 mugs?

Ans: \$ _____

2. The table records the time taken by four students to complete a race.

Student	Time in seconds
Ali	12.1
Bing Wen	11.9
Charlie	13.8
Devi	11.8

- (a) Who was the fastest?
(b) What was the average time taken by the four students to complete the race?

Ans: (a) _____

(b) _____ s

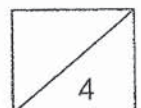

3. 3 pears cost \$1 more than 4 apples. Given that the cost of 4 apples is \$y,
(a) Express the cost of an apple in terms of y.
(b) Express the cost of 12 pears in terms of y.

Do not write in
this column

Ans: (a) \$ _____

(b) \$ _____

4. Joshua had a square piece of paper and cut it into 3 triangles. The ratio of the area of the triangles A to B to C is 1 : 2 : 3. Illustrate how Joshua cut the square piece of paper below and label triangles A and B clearly.

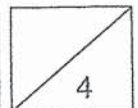
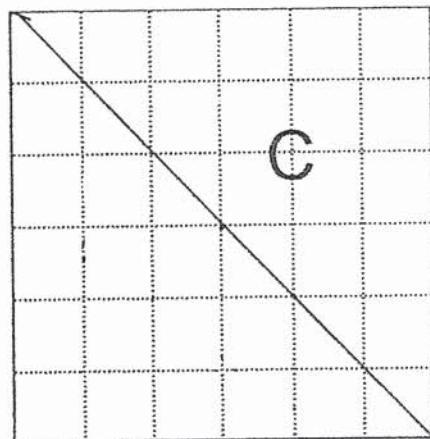

5. In the figure below, not drawn to scale, Rectangle ABCD is cut into 3 parts. The area of 2 of the rectangles are 20 cm^2 and 30 cm^2 . Find the area of the shaded rectangle.

Do not write in this column

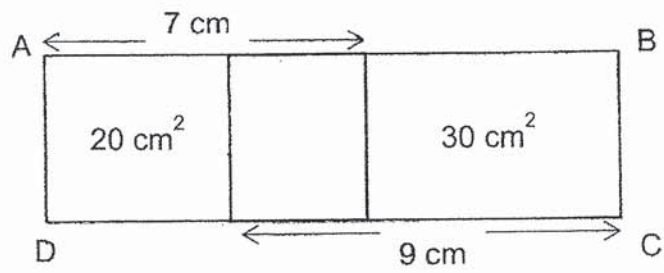

Ans: _____ cm^2 [2]

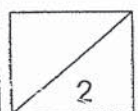

For questions 6 to 17, show your working clearly in the space below each question and write your answers in the spaces provided. The number of marks awarded is shown in brackets [] at the end of each question or part-question. (45 marks)

Do not write in this column

6. Mr Chan and Mr Toh had some money. $\frac{1}{4}$ of Mr Chan's money was \$33 more than $\frac{1}{3}$ of Mr Toh's. If they had \$1000 altogether, how much money does Mr Toh have?

Ans: _____ [3]

7. Mrs Anand had some pasta sauce and wanted to add some minced meat into the sauce. After adding 240 g of minced meat, $\frac{3}{5}$ of the mixture was made of sauce. She added more minced meat and, in the end, $\frac{9}{20}$ of the mixture was made of sauce. How much minced meat did Mrs Anand add to the pasta sauce altogether?

Ans: _____ [3]

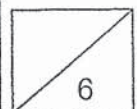

8. At ABC bookshop, there were 3 times as many pens as rulers. After selling an equal number of pens and rulers, there 5 times as many pens as rulers left. Given that there were 35 pens left, how many stationery did ABC bookshop sell altogether?

Do not write in this column

Ans: _____ [3]

9. In the space below, $\angle DAB$ is 55° . ABCD is a trapezium where AB is parallel to CD and BC is perpendicular to CD.
(a) Complete the trapezium by drawing 2 lines and label point C.
(b) Measure the length of CD.

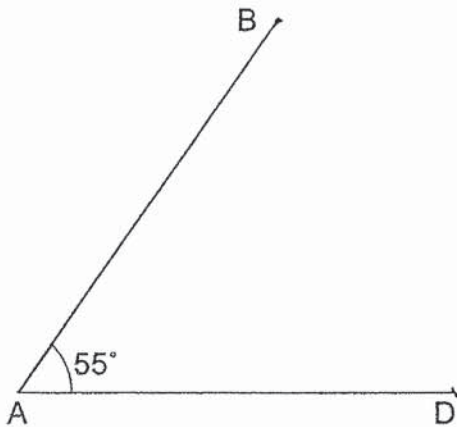

[2]

Ans: (b) _____ [1]

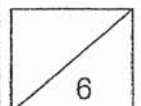

10. A gym ball, 20 cm in diameter, was rolled across the length of a 510-cm room and back to its original position. How many **complete rotations** did the gym ball make?

Do not write in this column

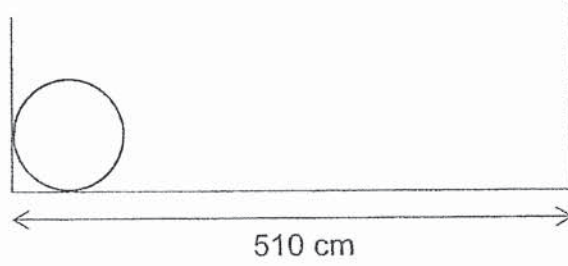

Ans: _____ [3]

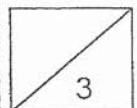

11. Danny stacked 8 cubes 2-cm cubes and glued them together to form the solid below.

Do not write in this column

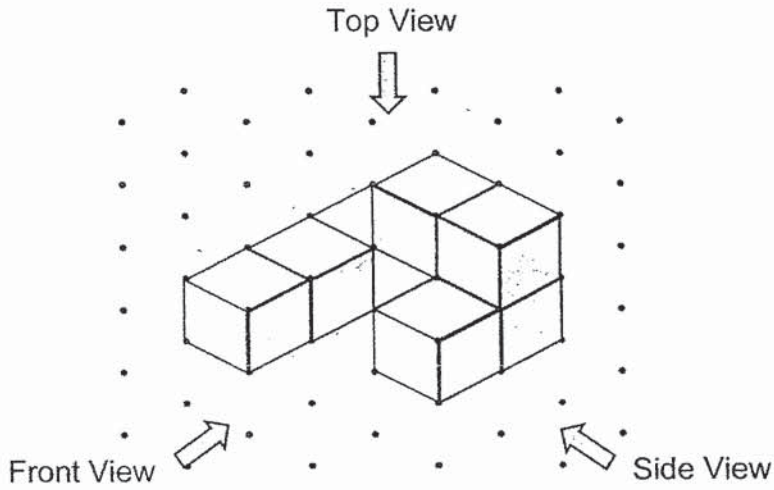

- (a) Draw the top and side view of the solid on the grids below.

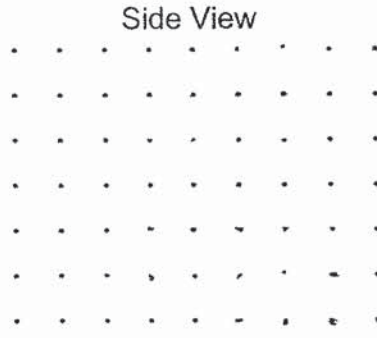
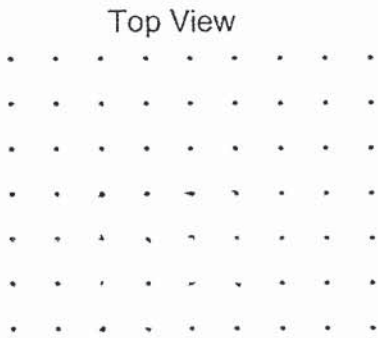

[2]

- (b) Danny decided to paint the solid, including the base, blue. What is the total surface area he had to paint?

Ans: (b) _____ [2]

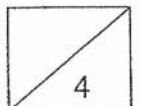

12. In the figure below, not drawn to scale, ABCD is a rectangle and EFDG is a square. Given that EGY and FGX are straight lines, and $\angle FDY$ is 235° , find
 (a) $\angle XGY$ and
 (b) $\angle FXA$

Do not write in this column

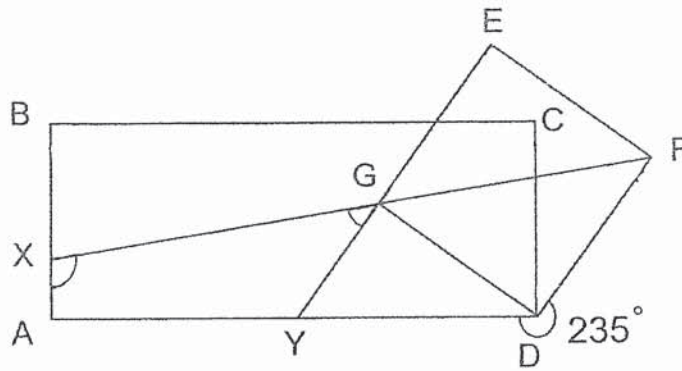

Ans: (a) _____ [1]

(b) _____ [3]

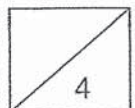

13. Mr Tan wanted to fill a tank, 120 cm long and 75 cm wide, with water. Tap A was turned on to fill the tank first while Tap B was turned on 3 minutes later. Mr Tan then left the taps running and only came back at the 12th minute mark. The graph below shows the height of the water in the tank over time.
- (a) Find the volume of the tank.
 (b) What is the rate of flow of water of Tap B in ℓ/min ?

Do not write in this column

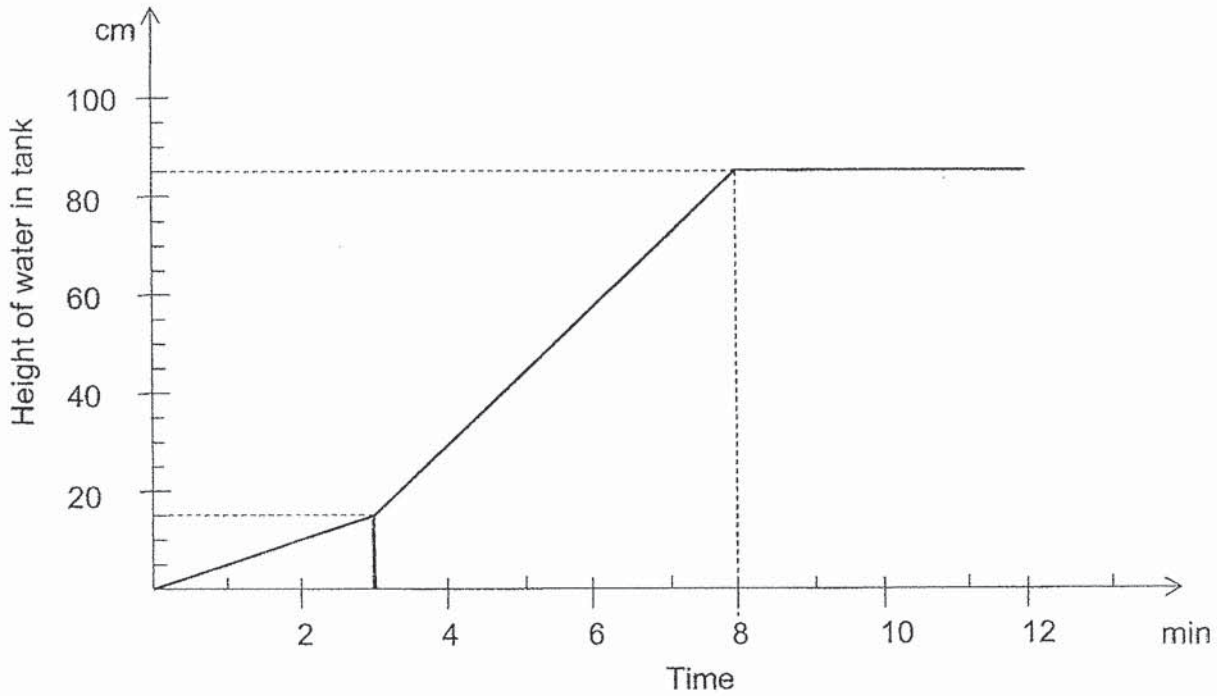

Ans: (a) _____ [2]

(b) _____ [3]

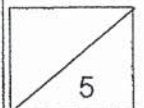

14. Dest Benki offered a combo deal where a refrigerator and a television set cost \$2340. In the end, it was a 22% discount of the original total.

Do not write in this column

- (a) How much was the total cost of a refrigerator and television set originally?
- (b) Given that the original cost of the television set was \$1100, find the original cost of the refrigerator.

Ans: (a) _____ [2]

(b) _____ [2]

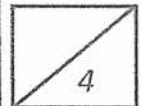

15. Sally wanted to make a card using semi-circles and quadrants of radius 1.5 cm all around a rectangular card. She attached the design using pins as shown below. The length of the rectangular card is 24 cm and its perimeter is 72 cm. Find the total area of the card.
(Using the value of π in the calculator, round off your answer to 2 decimal places.)

Do not write in
this column

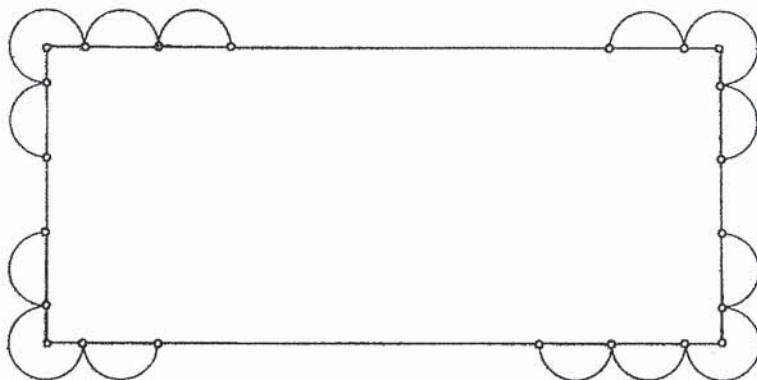

Ans: _____ [5]

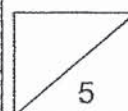

Do not write in
this column

16. Mrs Salim spent \$88.40 on some files and notebooks. She spent \$18.40 more on files than notebooks. She bought $\frac{3}{7}$ as many files as notebooks. Each file costs \$3.20 more than a notebook. How much does each file cost?

Ans: _____ [4]

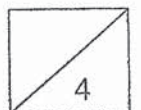

17. A group of students went on a trip to the Zoo and was split equally into two groups. Group A had 8 more girls than boys. When 4 boys from Group A joined group B, the number of boys in Group A and B became the same. Given that there are 56 girls altogether, how many students went to the Zoo?

Do not write in
this column

Ans: _____ [4]

End of Paper 2
~ Please check your work thoroughly. ~

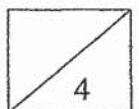

ANSWER KEY

YEAR : 2021
 LEVEL : PRIMARY 6
 SCHOOL : SCGS
 SUBJECT : MATHEMATICS
 TERM : PRELIMINARY



BOOKLET A (PAPER 1)

Q1	4	Q2	2	Q3	3	Q4	3	Q5	1
Q6	2	Q7	4	Q8	4	Q9	4	Q10	2
Q11	2	Q12	1	Q13	4	Q14	1	Q15	1

BOOKLET B (PAPER 1)

Q16	1.86	Q17	$5 \div 8 = 0.625$ $3.625 \approx 3.63$
Q18	100% - \$20 1% - \$0.20 7% - $\$0.20 \times 7 = \1.40 $\$20 + \$1.40 = \$21.40$	Q19	$10 - 5 = 5$ $10 - 5$ $70 - 5 \times 7 = 35$ $35 + 5 = 40$
Q20	$99 \times 99 = 99 (9 \times 11)$ $= 9 \times 11 = 11h$	Q21	$\$1.50 + \$0.50 = \$2.00$ $\$1.50 \times 3 = \4.50 $\$2.00 \times 3 = \6.00 $\$6.00 + \$4.50 = \$10.50$
Q22	$4 \times 3 = 12$ $3 \times 3 = 9$ $12 \times 3 = 36$ $36 + 9 + 12 + 12 = 69$	Q23	Total no. of pages = $10 \times 7 = 70$ $70 \div 5 = 14$
Q24	$\angle ADC = 180^\circ - 65^\circ = 115^\circ$ $115^\circ - 65^\circ = 50^\circ$	Q25	$12E = 3p$ $1p = 12 \div 3 = 4E$ $12 - 4 = 8$
Q26	$8 \times 4 = 32$ $32 \div 2 = 16 \text{cm}^2$	Q27	$2L \times 3 = 6L$ $6 \div \frac{1}{8} = \frac{6}{1} \times \frac{8}{1} = \frac{48}{1} = 48$
Q28	$90^\circ - 60^\circ = 30^\circ$ Arc - $(\frac{30}{360})(2 \times \pi \times 60)$ $= \frac{1}{12} \times 2 \times \pi \times 60 = 10\pi$ $10\pi + 10\pi + 60 = 20\pi + 60 \text{cm}$	Q29	$3 \times 1 = 3$ $5 \times 2 = 10$ $8 \times 3 = 24$ $4 \times 4 = 16$ $16 + 24 + 10 + 3 = 53$
Q30	a) False b) True		

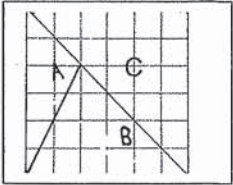
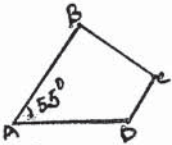
PAPER 2

Q1	$\$1.90 \times 10 = \19	Q2	a) Devi b) $49.6 \div 4 = 12.4s$
Q3	<p>a) $3p = 4a + \\$1$ $4a = \\$y$ $1a = \\$(\frac{y}{4})$</p> <p>b) $4 \times (y+1) = \\$(4y+4)$</p>	Q4	<p>$\frac{1}{2} \times 6 \times 6 = 18$</p> <p>C - 18units</p> <p>$3u - 18$</p> <p>A-$1u - 6$</p> <p>B- $12u$</p> 
Q5	Area = $5 \times 3 = 15cm^2$	Q6	<p>$33 \times 4 = 132$</p> <p>$1000 - 132 = 868$</p> <p>$7u \# 868$</p> <p>$1u = 868 \div 7 = 124$</p> <p>$3u = 124 \times 3 = \\$372$</p>
Q7	<p>$6u - 240$</p> <p>$1u - 40$</p> <p>$11u - 440g$</p>	Q8	<p>$5u - 35$</p> <p>$1u - 35 \div 5 = 7$</p> <p>$2u - 7 \times 2 = 14$</p>
Q9	<p>a)</p>  <p>b) 2.9cm</p>	Q10	<p>$510 - 20 = 490$</p> <p>$490 \div 20\pi \approx 7 \text{ rounds}$</p> <p>$7 \times 2 = 14$</p>
Q11	<p>a) Top View</p>  <p>Side View</p>  <p>b) Top = 6 Front = 5 Side = 5 $(5 + 5 + 6) \times 4 \times 2 = 128$</p>	Q12	<p>a) $\angle XGY = 45^\circ$</p> <p>b) $360^\circ - 90^\circ - 45^\circ - 125^\circ = 100^\circ$</p>
Q13	<p>a) $120 \times 75 \times 85 = 765000cm^3$</p> <p>b) $120 \times 75 \times 15 = 135000$ $135000 \div 3 = 45000$ $70 \times 120 \times 75 = 630000$ $45000 \times 5 = 225000$ $630000 - 225000 = 405000$ $405000 \div 5 = 81000 \approx 81L/m^3$</p>	Q14	<p>a) $100\% - 22\% = 78\%$ $78\% - \\$2340$ $1\% - \\$2340 \div 78 = \\30 $100\% - \\$30 \times 100 = \\3000</p> <p>b) $\\$3000 - \\$1100 = \\$1900$</p>
Q15	<p>$72 - 24 - 24 = 24$</p> <p>$24 \div 2 = 12$</p> <p>Area of rec = $12 \times 24 = 288$</p> <p>$12 \div 1.5 = 8$</p> <p>$8 - 6 = 2$</p>	Q16	<p>$35 \div 7 = 5$</p> <p>$53.40 \div 3 = 17.80$</p> <p>$12.80 \div 3.20 = 4 \text{ units}$</p> <p>$3 \times 4 = 12$</p> <p>$\frac{53.40}{12} = 4.45$</p>

	$24 \div 1.5 = 16$ $16 - 8 = 8$ Area of $\frac{1}{4}$ circle = $\pi \times 1.5 \times 1.5 \times \frac{1}{4}$ $= 1.767$ No. of $\frac{1}{4}$ circle = $32 + 2 + 8 + 8 + 2$ $= 52$ Area of all $\frac{1}{4}$ circle = 52×1.767 $= 91.884$ Area of total = $91.884 + 288$ $= 379.884 \approx 379.88 \text{ cm}^2$		
Q17	$1u + 8 + 1u + 16 = 56$ $2u + 24 = 56$ $2u = 32$ $1u = 16$ $1u + 1u + 8$ $16 + 16 + 8$ $= 32$		