



PRIMARY 5 END-OF-YEAR EXAMINATION

Name : _____ ()

Date: 27 October 2021

Class : Primary 5 ()

Time: 8.00 a.m. - 9.45 a.m.

Duration: 1 hour 45 minutes

SCIENCE BOOKLET A

INSTRUCTIONS TO CANDIDATES

1. Write your name, class and register number.
2. Do not turn over this page until you are told to do so.
3. Follow all instructions carefully.
4. Answer all questions.
5. Shade your answers on the Optical Answer Sheet (OAS) provided.

Booklet A (28 x 2 marks)

For each question from 1 to 28, four options are given. One of them is the correct answer. Make your choice (1, 2, 3 or 4) and shade your answer on the Optical Answer Sheet.

(56 marks)

1. The diagram below shows the fruits W and Y.

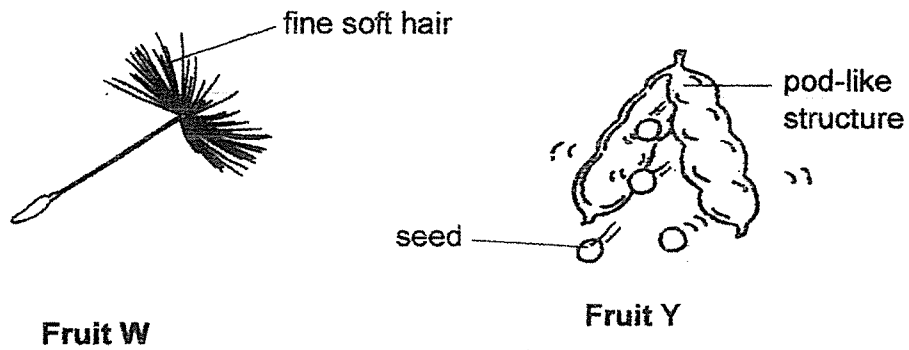

How are fruits W and Y dispersed?

	W	Y
(1)	animals	splitting
(2)	wind	animals
(3)	animals	wind
(4)	wind	splitting

2. Ali performed an experiment using a flower. The flower has parts A, B, C and D as shown below.

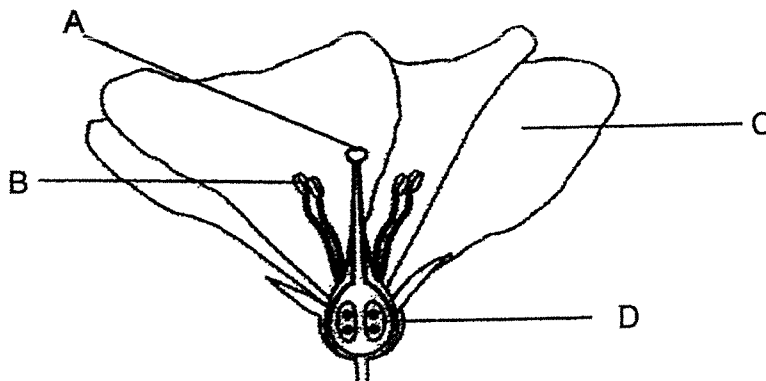





He dusted some pollen grains on the flower. Then, he removed two parts from the flower. After some time, he observed that the flower developed into a fruit.

Which of the following correctly shows the parts of the flower that have been removed?

	Parts Removed
(1)	A and D
(2)	B and C
(3)	B and D
(4)	C and D

3. Jack grew some seeds of a plant under different conditions on Day 1. He recorded his observations of the seeds on Day 5 as shown in the table below.

Tray	Soil	Presence of light	Appearance of seeds on Day 5
A	dry	no	
B	wet	yes	
C	dry	yes	
D	wet	no	

Based only on the results shown above, what can Jack conclude about the germination of seeds?

- (1) Light is required.
- (2) Water is required.
- (3) Light and air are required.
- (4) Water, air and warmth are required for germination.

4. The diagram below shows the female reproductive system of a human.

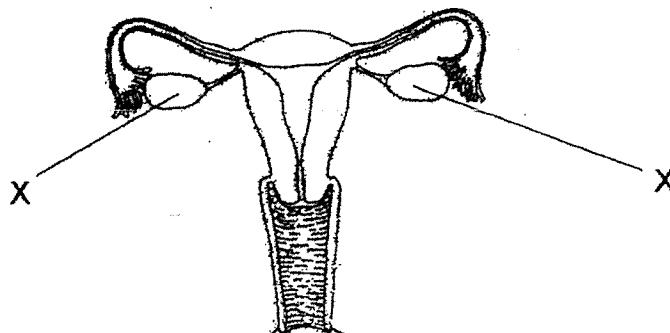

A woman will not be able to have babies if both parts X are removed. Which of the following reason explains why the woman will not be able to have babies?

- (1) No food will be provided for the baby.
 - (2) There is no place for the baby to develop.
 - (3) No eggs can be produced for fertilisation.
 - (4) No sperms can be produced for fertilisation.
5. Which of the following shows the correct difference between the reproductive cells in flowering plants and humans?

Male Reproductive Cell		
	In flowering plants	In humans
(1)	It cannot be seen with naked eye.	It can be seen with naked eye.
(2)	It is produced in the anther.	It is produced in the testes.
(3)	It fuses with the female reproductive cell during pollination.	It fuses with the female reproductive cell during fertilisation.
(4)	It contains traits of both parent plants.	It contains traits of the father only.

6. The diagram below shows the movement of substances X, Y and Q in a plant.

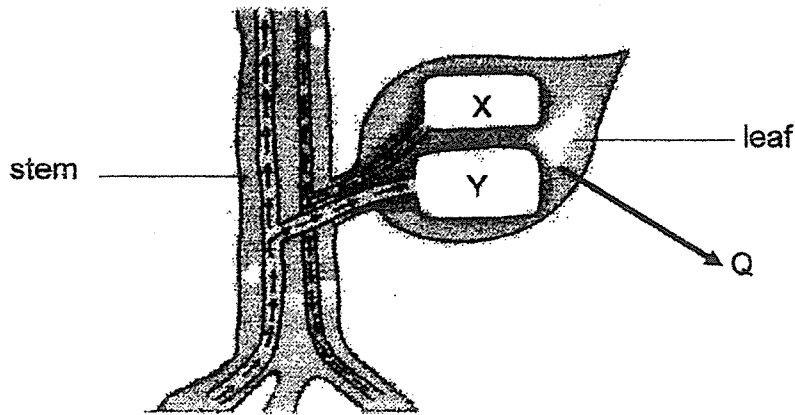

What are substances X, Y and Q?

	X	Y	Q
(1)	water	food	water vapour
(2)	food	oxygen	water
(3)	water	food	oxygen
(4)	food	water	water vapour

7. The diagram below shows the movement of blood in a human heart.

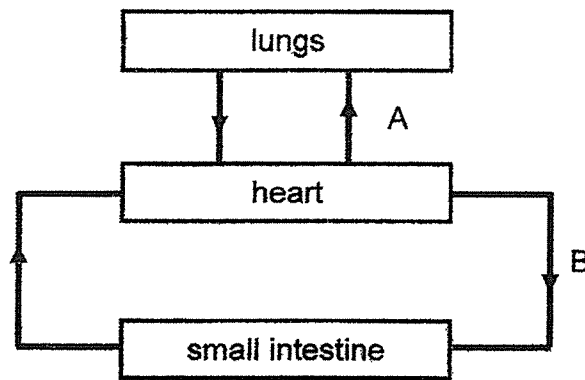

Which of the following correctly states the amount of gases in A and B?

	A	B
(1)	rich in carbon dioxide	rich in oxygen
(2)	poor in carbon dioxide	poor in oxygen
(3)	rich in carbon dioxide	poor in oxygen
(4)	poor in carbon dioxide	rich in oxygen

8. Jamus wants to find out the effect of overcrowding on the growth of Plant Y.

Pot	Number of seeds of Plant Y	Size of pot
A	15	big
B	5	small
C	10	medium
D	15	small
E	15	medium

Which three pots, A, B, C, D and/ or E should Jamus choose to have a fair test?

- (1) A, B and C
- (2) A, D and E
- (3) B, C and D
- (4) B, C and E

9. Aloysius took his pulse rate and breathing rate before and after a vigorous exercise. His results are in the table below.

		Pulse rate (beats per minute)	Breathing rate (breaths per minute)
At rest		70	15
After exercise ended	1 min	175	50
	2 min	136	35

What could his pulse rate and breathing rate most probably be, 3 minutes after he had ended his vigorous exercise?

	Pulse rate	Breathing rate
(1)	175	50
(2)	112	35
(3)	80	20
(4)	40	10

10. The picture below shows the respiratory system in a human body.

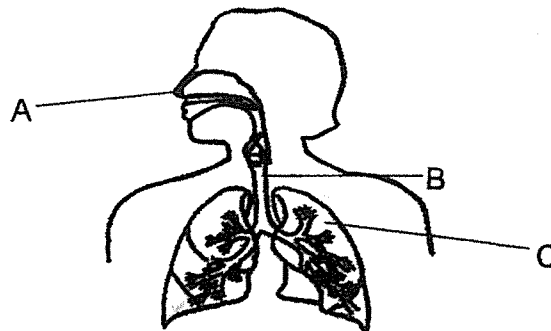

What are parts A, B and C?

	A	B	C
(1)	nose	gullet	lung
(2)	nose	windpipe	lung
(3)	mouth	gullet	stomach
(4)	nose	windpipe	stomach

11. The graph below shows the amount of undigested food before it enters the parts of the human digestive system. Parts A, B, C and D are not labelled in sequence of the digestive system.

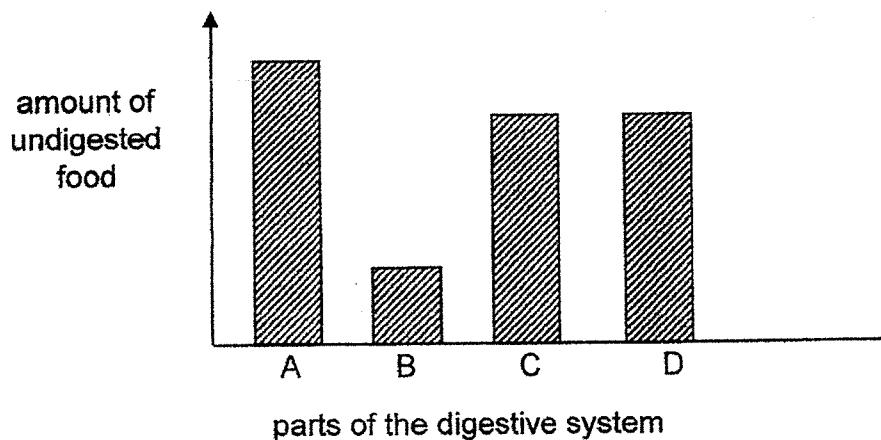

Which of the following correctly identifies parts A, B, C and D?

	A	B	C	D
(1)	mouth	small intestine	gullet	stomach
(2)	gullet	small intestine	stomach	mouth
(3)	mouth	gullet	small intestine	large intestine
(4)	mouth	gullet	stomach	small intestine

12. The diagram below shows a cell.

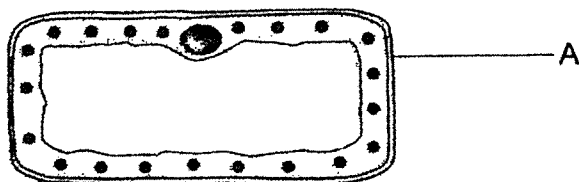

What is the function of part A?

- (1) It controls cell activities.
- (2) It gives the cell its fixed shape.
- (3) It traps sunlight for photosynthesis.
- (4) It contains information on characteristics to be passed down from one generation to another.

13. Nura placed some cells in a dish of liquid with substances A and B. After 5 hours, Nura drew the observations of her cells.

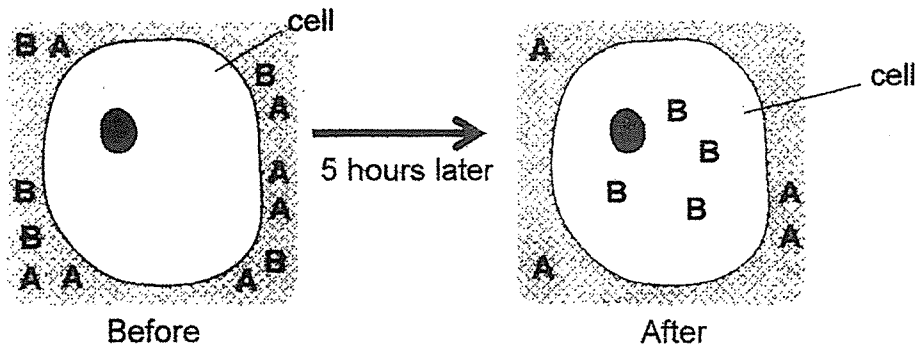

Which part of the cell is responsible for the above observations?

- (1) cell wall
 - (2) cytoplasm
 - (3) chloroplast
 - (4) cell membrane
14. Study the classification chart below.

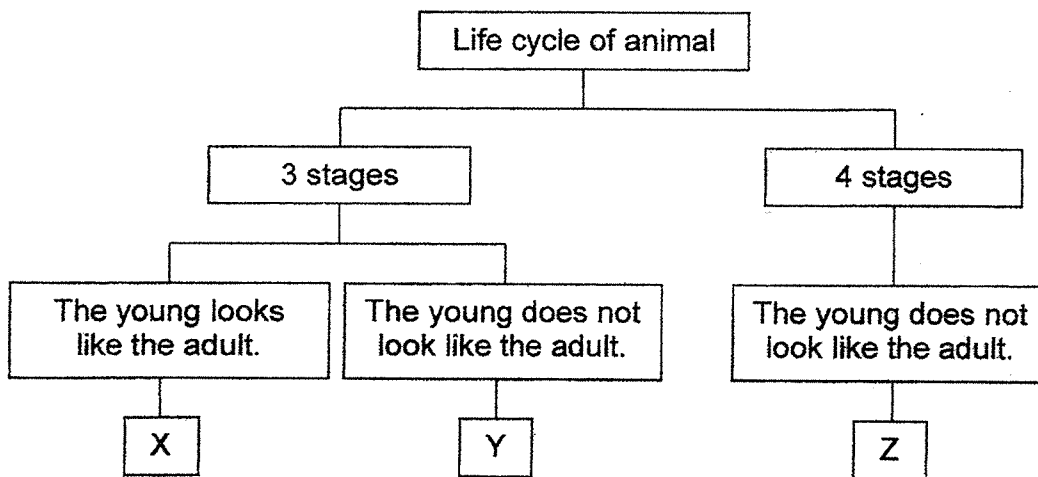

Which one of the following shows the animals represented by X, Y and Z?

	X	Y	Z
(1)	cockroach	beetle	mosquito
(2)	chicken	frog	butterfly
(3)	frog	chicken	butterfly
(4)	cockroach	mosquito	frog

15. Three plants, S, T and U, were planted on a piece of land as shown in Diagram 1 below. Diagram 2 shows the same piece of land a few months later with young plants growing.

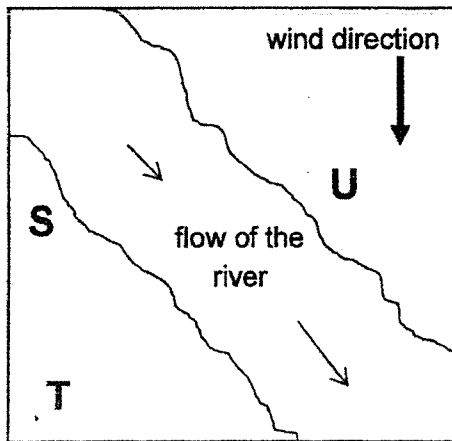

Diagram 1

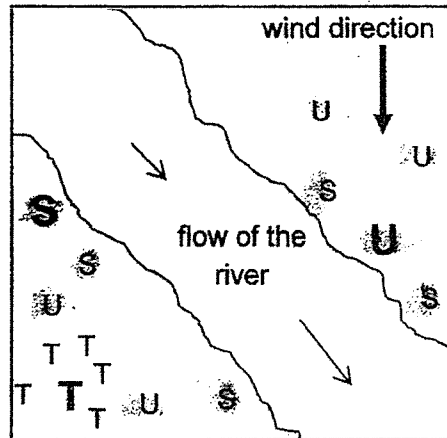

Diagram 2

Legend:	
S	: adult plant of S
S	: young plant of S
T	: adult plant of T
T	: young plant of T
U	: adult plant of U
U	: young plant of U

What are the methods of dispersal for the seeds of plants, S, T and U?

	S	T	U
(1)	water	splitting	animal
(2)	water	wind	splitting
(3)	wind	water	splitting
(4)	wind	splitting	water

16. Ali wanted to find the most suitable material to make a pair of shoes for himself to keep his feet dry on rainy days. He carried out an experiment with the set-up below. He poured 100 ml of water onto material R. He measured the amount of water collected in the beaker after 5 minutes.

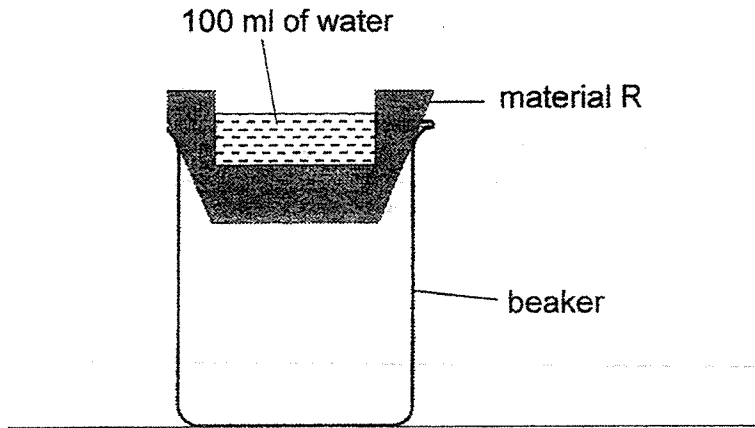

He repeated the experiment with materials S, T and U and recorded his results in the table below.

Material	After 5 minutes	
	Amount of water collected in the beaker (ml)	Amount of water left on the material (ml)
R	40	40
S	100	0
T	0	0
U	0	100

Which material should Ali use to make the pair of shoes?

- (1) R
- (2) S
- (3) T
- (4) U

17. The diagram below shows the processes, A, B, C and D, involved in the changes of the state of water.

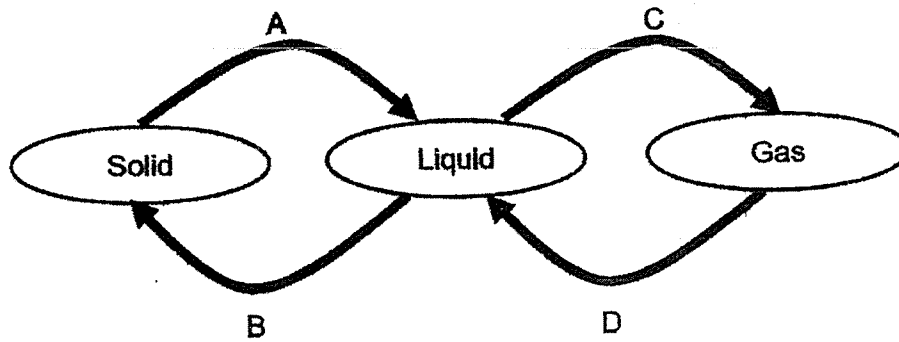

Which of the following correctly states if heat is gained or lost in each of the process?

	A	B	C	D
(1)	heat gain	heat gain	heat loss	heat loss
(2)	heat gain	heat loss	heat gain	heat loss
(3)	heat loss	heat gain	heat loss	heat gain
(4)	heat loss	heat loss	heat gain	heat gain

18. The table below shows the boiling point and melting point of substance X.

Substance X	
Melting point	Boiling point
50°C	170°C

What will be the state of substance X at 25°C and 165°C?

state of substance X		
	at 25°C	at 165°C
(1)	solid	gas
(2)	solid	liquid
(3)	liquid	gas
(4)	liquid	liquid

19. Daniel conducted an experiment using four identical towels, P, Q, R and S. He soaked each towel in 200 ml of water. Then, he folded each towel differently and hung them in the sun as shown below.

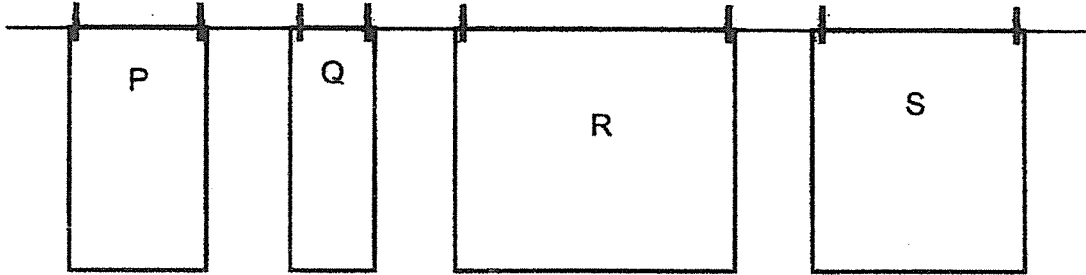

He recorded the mass of each towel after 30 minutes.

Which of the following graph correctly shows the mass of each towel?

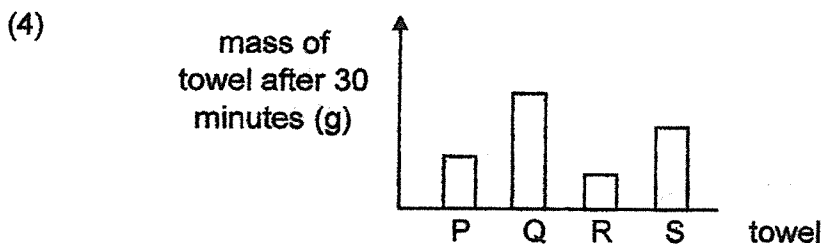
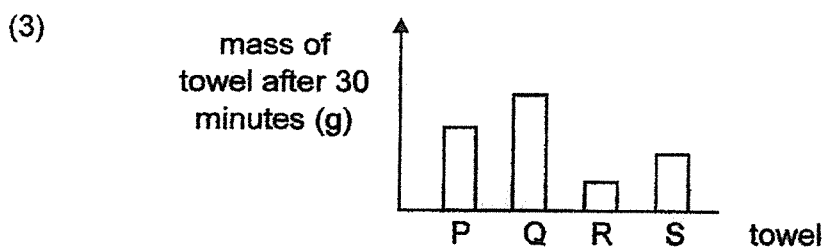
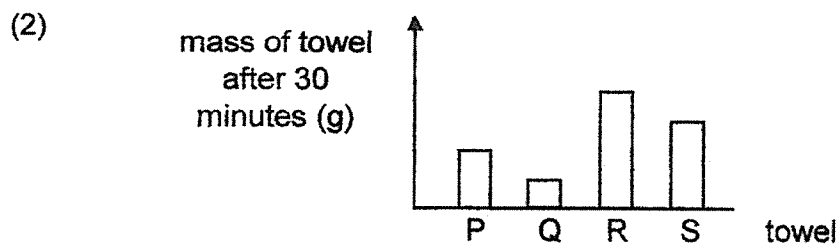
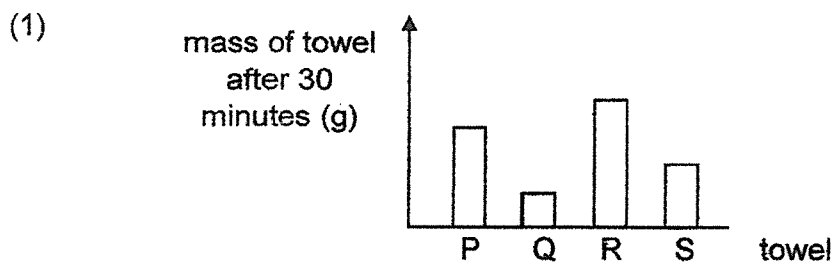

20. Sarah placed two glasses of water in a room at 30°C as shown in the diagram below. The amount of water in each glass is the same.

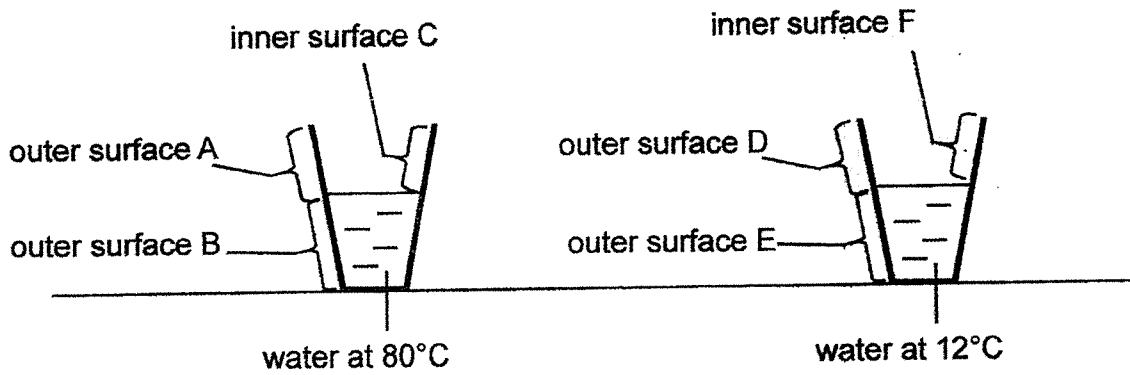

After a short while, Sarah observed that water droplets were formed on some parts of each glass. On which parts of the glasses would water droplets be observed?

- (1) *B and F*
 - (2) *C and E*
 - (3) *A, B and F*
 - (4) *B, D and F*
21. Fahan has a wooden pencil with an exposed material X as shown in the diagram below.

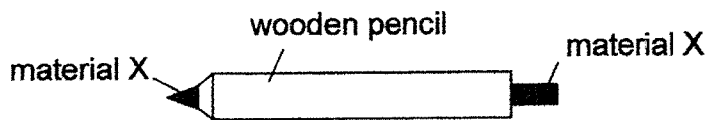

Which of the electric circuits should Fahan use to test if material X is a conductor of electricity?

- (1)
- (2)
- (3)
- (4)

22. Materials P and Q were connected to circuits A and B as shown in the diagrams below. The bulb in circuit A did not light up, but the bulb in circuit B lit up.

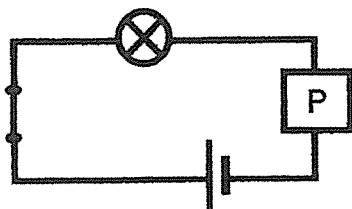

Circuit A

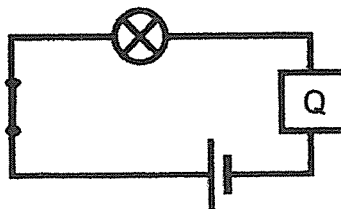

Circuit B

What could materials P and Q be?

	material P	material Q
(1)	iron	aluminium
(2)	rubber	plastic
(3)	glass	steel
(4)	steel	rubber

23. The diagram below shows a heat lamp used for keeping food warm. When the lamp is brighter, it gives off more heat.

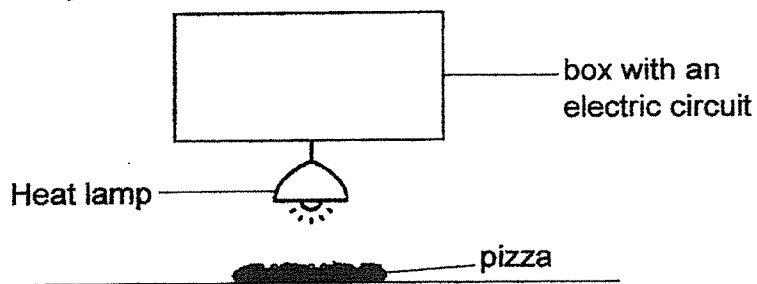

In which electric circuit shown below will the pizza be the warmest?

(1)

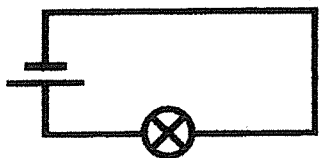

(2)

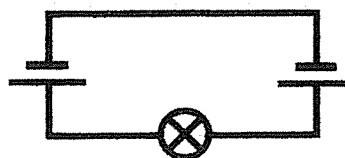

(3)

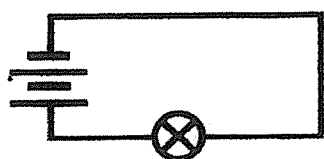

(4)

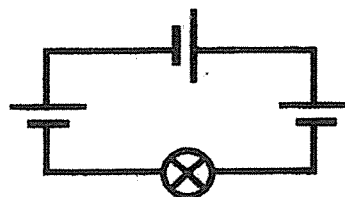

24. Four identical 10 cm long metal rods were each placed into different amount of water in the four beakers as shown below.

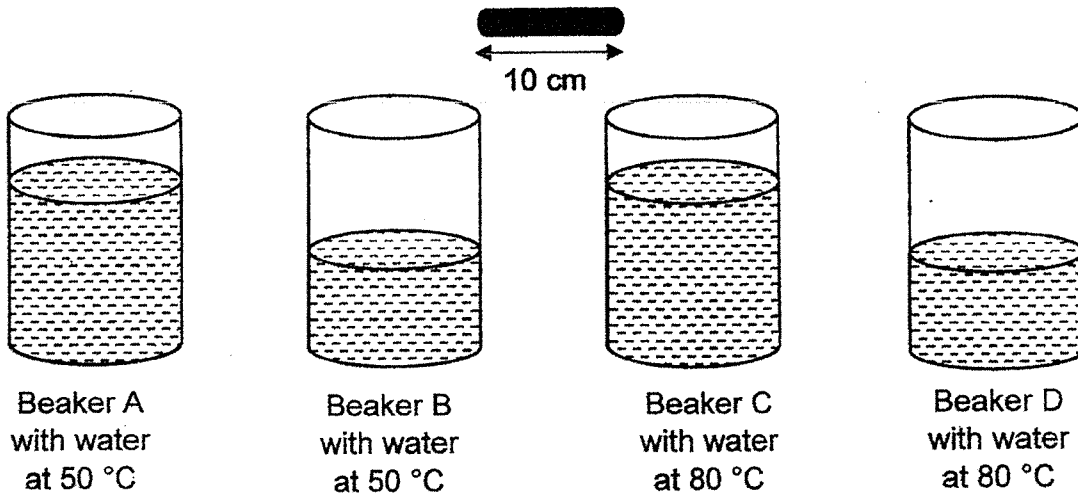

Which of the above beakers would have the longest metal rod after 5 minutes?

- (1) A
- (2) B
- (3) C
- (4) D

25. Three identical magnetic toy cars, X, Y and Z, were placed apart. When car Z was moved to the left, car X and car Y were pushed to the left as shown below.

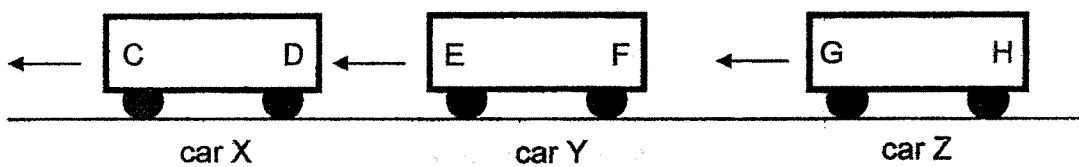

Based on the diagram above, what could be the poles at C, E and H?

	C	E	H
(1)	south	north	south
(2)	north	south	south
(3)	south	south	north
(4)	north	north	north

26. Ziko had four wooden blocks of different width, w , as shown below.

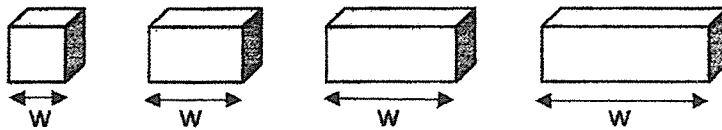

He put the blocks on a moving belt in a random order. Their positions are marked by X as shown in the diagram below. The arrow shows the direction in which the belt was moving.

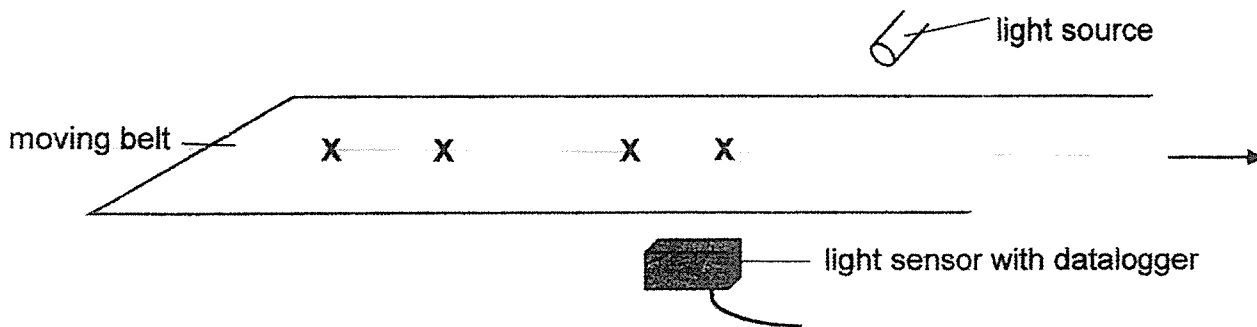

A light sensor was used to detect the wooden blocks on the belt. The graph below shows the results of the datalogger when the belt was switched on.

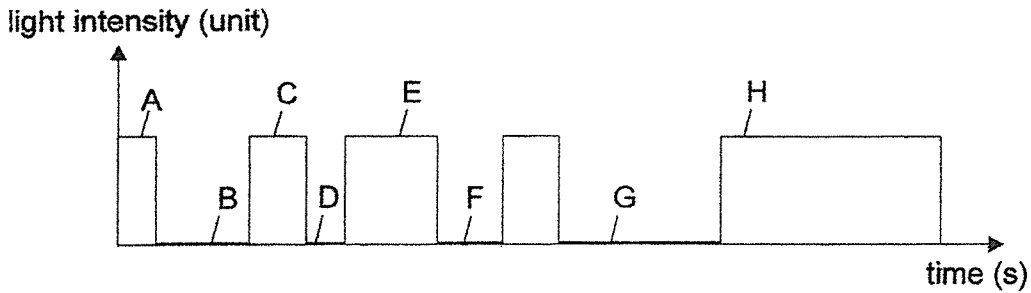

Which letter in the graph represent the blocks with shortest and longest w ?

	shortest w	longest w
(1)	A	B
(2)	C	H
(3)	D	G
(4)	F	E

at room temperature

27. Dhiya had two thick glasses, A and B, stuck together as shown in the diagram below.

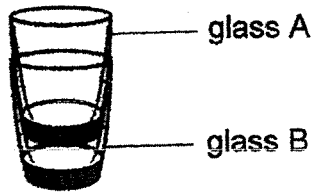

Which of the following methods could she use to separate the two glasses without breaking them?

<p>A</p> <p>ice cubes added into glass A</p>	<p>B</p> <p>water at 60°C</p>
<p>C</p> <p>water at 80°C poured into glass A</p>	<p>D</p> <p>water at 80°C poured into glass A</p> <p>water at 60°C</p>

- (1) A only
- (2) D only
- (3) A and B only
- (4) C and D only

28. Mr Tan filled three identical cylinders, J, K and L, each with either air, sponge or plasticine. The three cylinders are all fitted with pistons as shown in the diagram below.

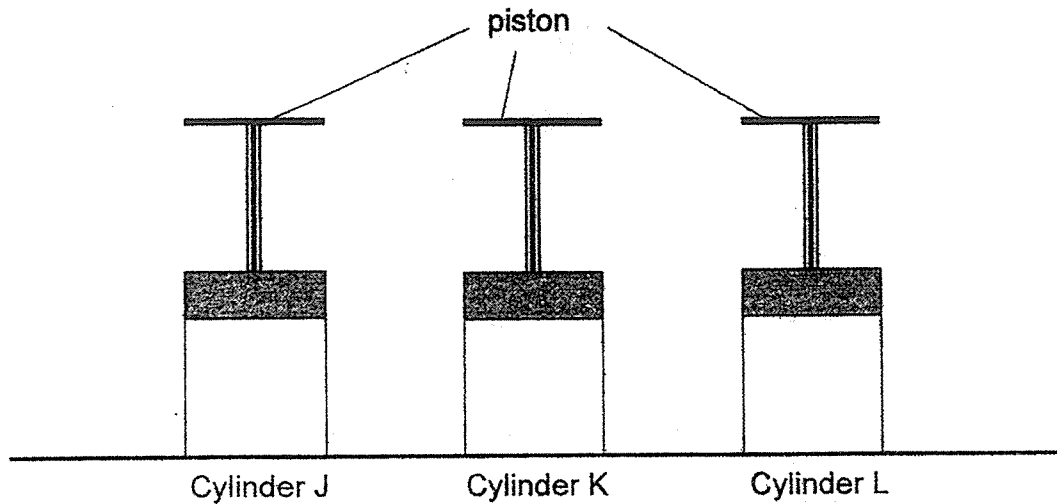

Then, Mr Tan placed identical weights on the pistons. The diagram below shows his observations.

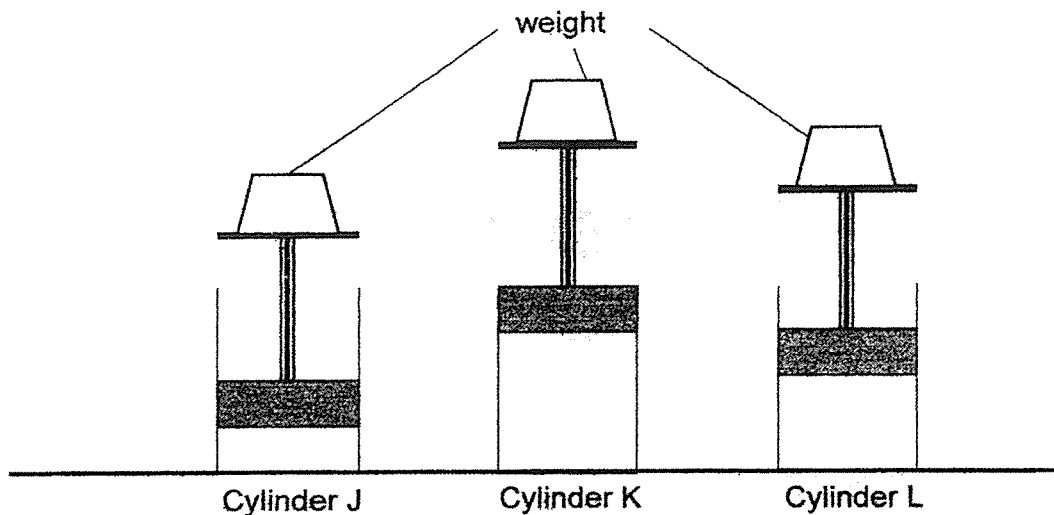

Which of the following correctly shows the substance in cylinders J, K and L?

	Cylinder J	Cylinder K	Cylinder L
(1)	air	sponge	plasticine
(2)	air	plasticine	sponge
(3)	sponge	air	plasticine
(4)	plasticine	sponge	air

End of Booklet A



PRIMARY 5 END-OF-YEAR EXAMINATION

Name : _____ ()

Date: 27 October 2021

Class : Primary 5 ()

Time: 8.00 a.m. – 9.45 a.m.

Parent's Signature : _____

Duration: 1 hour 45 minutes

SCIENCE

BOOKLET B

INSTRUCTIONS TO CANDIDATES

1. Write your name, class and register number.
2. Do not turn over this page until you are told to do so.
3. Follow all instructions carefully.
4. Answer all questions.
5. Write your answers in the booklet.

Booklet A	56
Booklet B	44
Total	100

Booklet B (44 marks)

For questions 29 to 40, write your answers clearly in this booklet.

The number of marks available is shown in brackets [] at the end of each question or part question.

(44 marks)

29. The diagrams below show the male and female reproductive systems of a human.

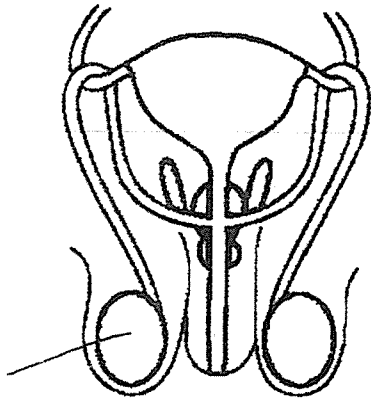

male reproductive system

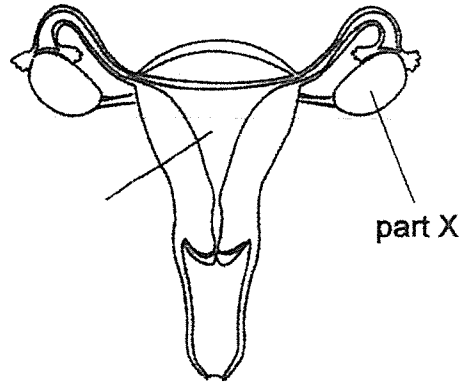

female reproductive system

(a) In the above diagram, identify and label the part where the fertilised egg develops. [1]

(b) In the above diagram, identify and label the part where the sperm is produced. [1]

(c) Which part of the plant reproductive system has the same function as part X? [1]

Score	3
-------	---

30. The diagram below shows fruit X.

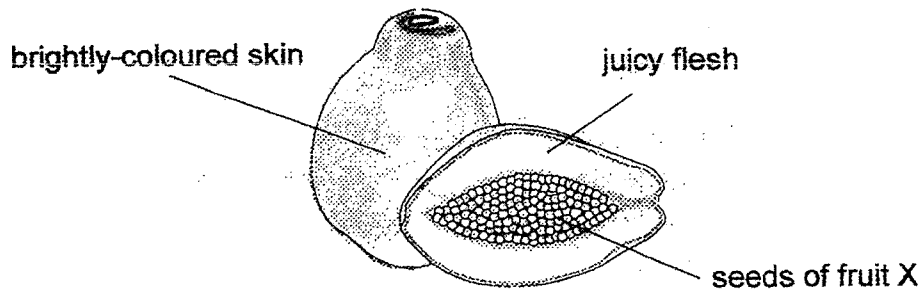

(a) State the method of dispersal of fruit X. [1]

(b) Based on the diagram, explain how seeds of fruit X are dispersed. [2]

(c) State one advantage of having many seeds in fruit X.

Score	4
-------	---

31. Study the flowchart below.

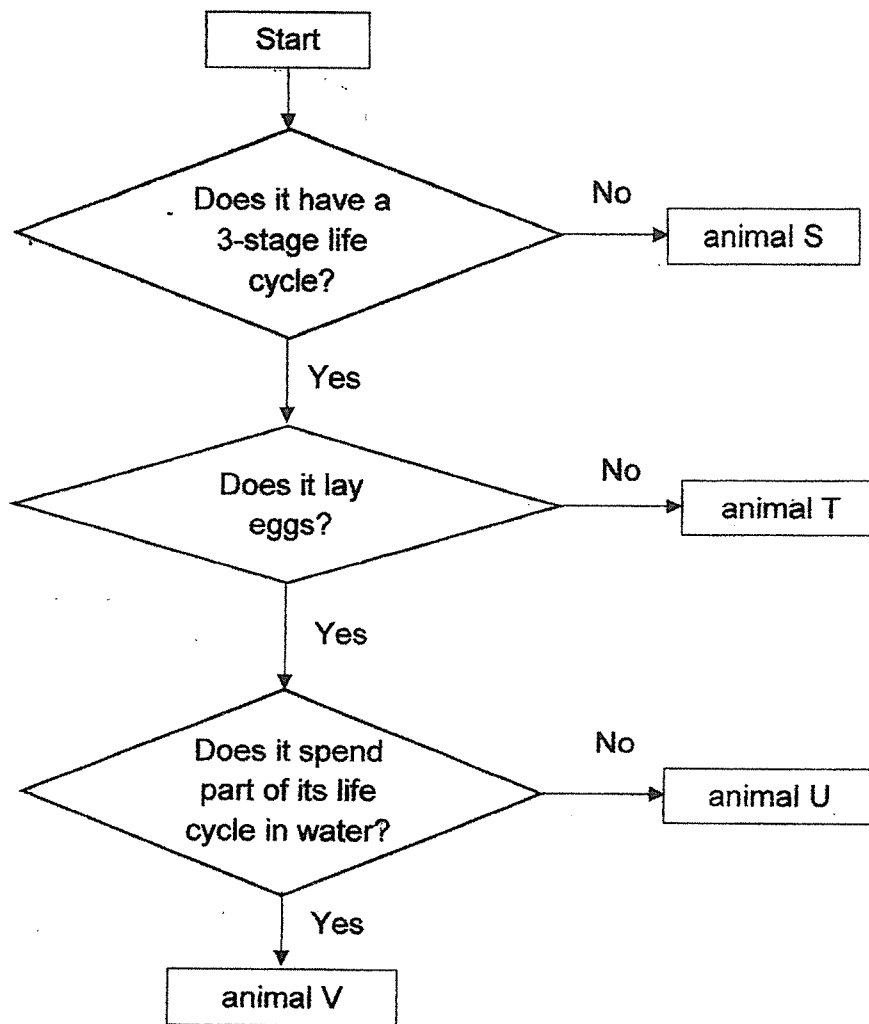

(a) Based on the flowchart, state a difference between animal S and animal T. [1]

(b) Based on the flowchart, state two characteristics of animal V [1]

(c) Which animal, S, T, U or V, is likely to be a grasshopper? [1]

Score	3
-------	---

32. The table below shows the characteristics of cells P, Q and R.

Cell P	Cell Q	Cell R
Has a fixed shape	Does not have a fixed shape	Has a fixed shape
Can photosynthesise	Cannot photosynthesise	Cannot photosynthesise

(a) From the information above, identify whether cells P, Q and R is an animal cell or plant cell. [1]

Plant cell: _____

Animal cell: _____

(b) Name a cell part that can be found in cell P but not in cell Q? [1]

Eugene discovered a single-celled organism S as shown in the diagram below. He concluded that organism S does not eat other organisms for food.

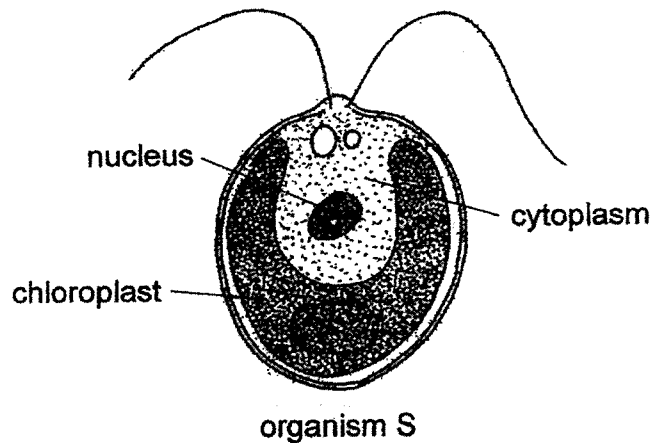

(c) Explain how Eugene arrived at his conclusion. [1]

Score	3
-------	---

33. Whenever Joanne takes a hot shower, the mirror in the bathroom mists up and she is unable to see her reflection clearly.

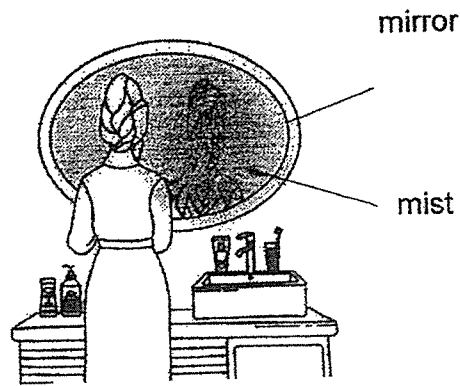

(a) Explain why the mirror mists up.

[2]

Joanne ties her hair up after her shower as shown in the diagram below.

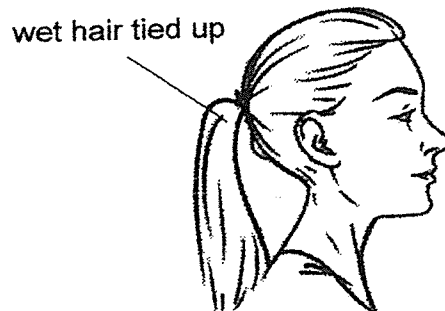

(b) Her mother advised her to let her hair down so that her hair could dry faster. Explain why Joanne's mother is correct.

[2]

Score	4
-------	---

Joanne wants to use a hairdryer to dry her hair. The hairdryer has three settings for wind speed and two settings for temperature.

(c) Which settings should Joanne choose to dry her hair fastest? Put a tick in the each of the table below. [1]

Wind speed	Low	Medium	High

Temperature	Low	High

Score	1
-------	---

34. (a) State a difference between evaporation and boiling. [1]

The diagram below shows the processes involved in the water cycle.

(b) Complete the water cycle in the diagram below. [1]

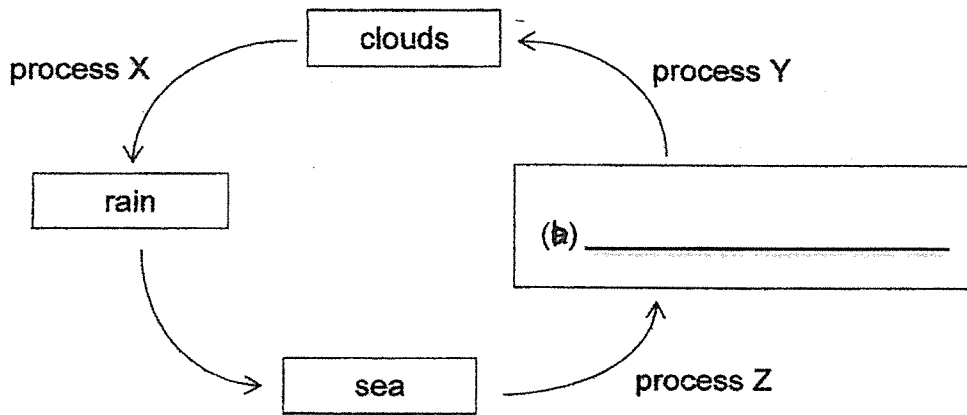

c (b) Based on the diagram above, which process, X, Y or Z, is involved when a puddle disappears on a hot day? [1]

(d) For each of the following, put a tick in the correct box to show how each activity helps to conserve water. [1]

	Activity	Reduce	Reuse	Recycle
(i)	Turning off the tap when brushing teeth.			
(ii)	Treating sewage water so that it can be used to wash our hands.			

Score	4
-------	---

35. Dinesh has four jackets, A, B, C and D, made of different materials. He set up an experiment shown below to find out how much light jacket A reflects. He repeated the experiment for jackets B, C and D using the same set-up.

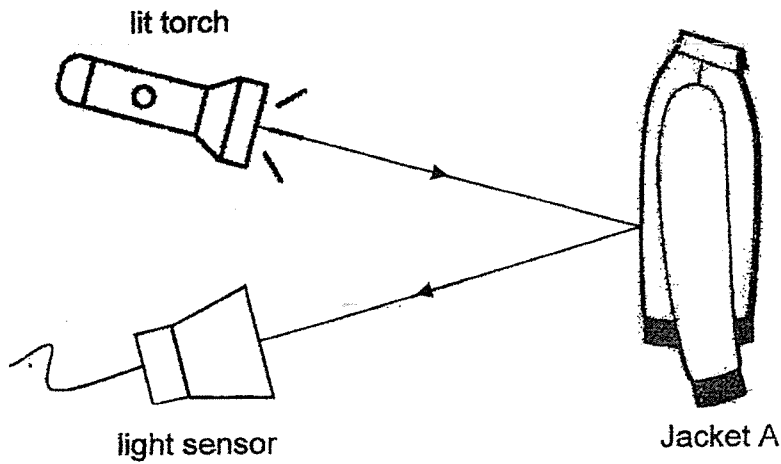

His results are shown in the table below.

Jacket	Light sensor reading (units)
A	1100
B	3500
C	4600
D	2700

- (a) State another variable to be kept constant to ensure a fair test. [1]

- (b) Based on the results, which jacket should Dinesh wear if he intends to go cycling on the road at night? Explain your answer. [2]

Score	3
-------	---

36. The table below shows the amount of oxygen in the air at different heights above sea level.

Height above sea level (m)	Percentage of oxygen in the air (%)
0	20.9
1000	20.1
2000	19.4
3000	18.6

- (a) What is the relationship between the height above sea level and the percentage of oxygen in the air? [1]

The graph below shows the breathing rate of an adult at different heights above sea level.

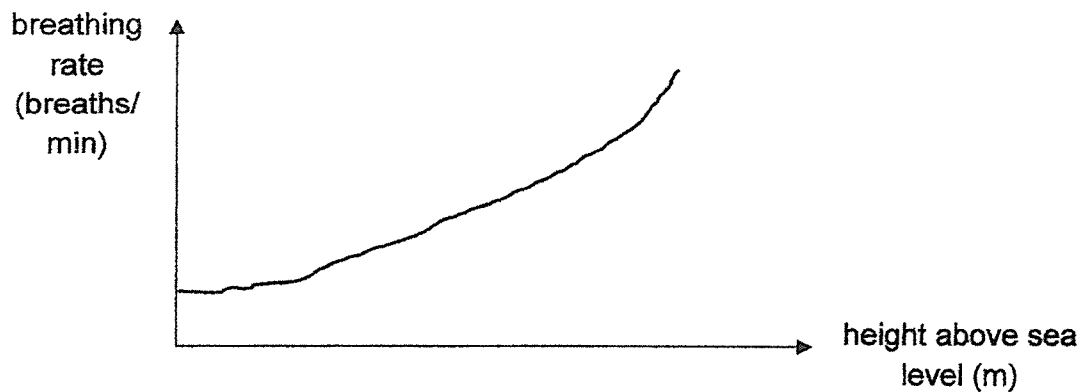

- (b) Based on the table above explain why breathing rate of an adult increases as the height above the sea level increases. [1]

The graph below shows Robin's heart rate as he climbed up a mountain.

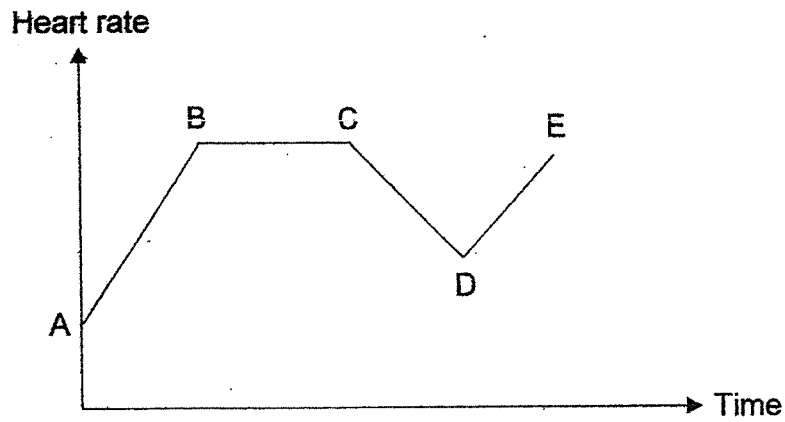

- (c) Based on the graph above, at which point, A, B, C, D or E, in the graph did Robin start taking a break? [1]

- (d) Explain your answer in (c), relating it to the rate of substances transported within the body. [2]

Score	3
-------	---

37. Ramly used a circuit tester as shown below to test a circuit card.

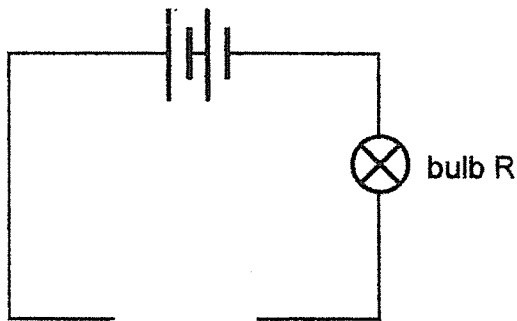

circuit tester

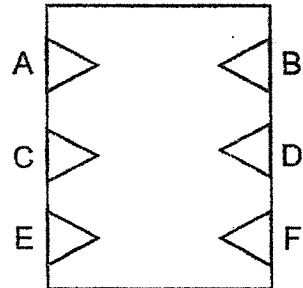

circuit card

The table below shows the results when the circuit tester is connected to the points, A, B, C, D, E or F, on the circuit card.

Circuit tester connected to the circuit card at the points	Does the bulb light up?
A and B	Yes
A and C	No
B and D	Yes
D and E	No
C and F	Yes

In the circuit card below, draw 3 lines to show how the points, A, B, C, D, E and F, are connected with 3 separate wires. [2]

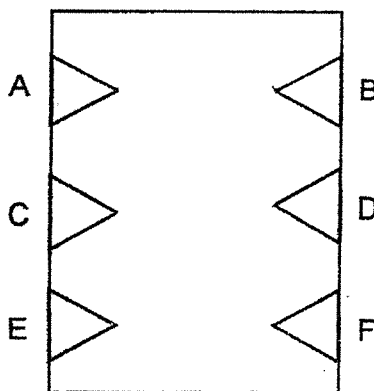

Score	2
-------	---

38. Vanessa set up a circuit as shown below.

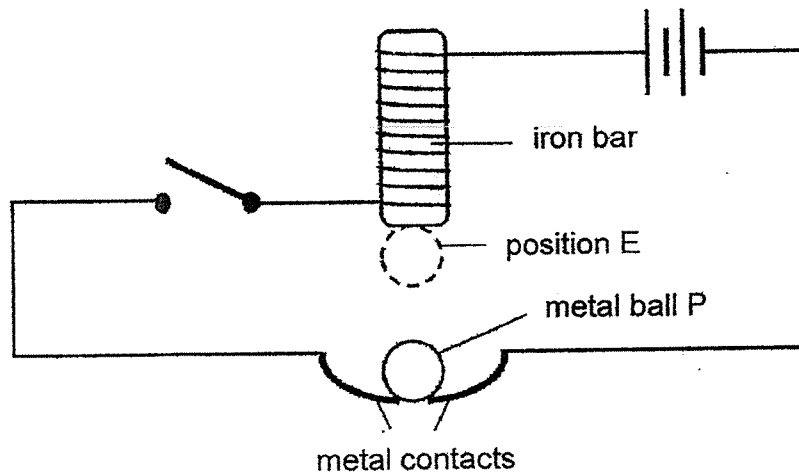

When the switch was closed, ball P moved up and down between the iron bar and the metal contacts repeatedly.

(a) Give an example of a metal that ball P is made of. [1]

(b) Explain why ball P is able to move to position E when the switch is closed. [2]

(c) Suggest two changes to the set-up such that the metal ball P moves to position E faster. [2]

Method 1: _____

Method 2: _____

Score	5
-------	---

39. Raudah set up a circuit as shown below.

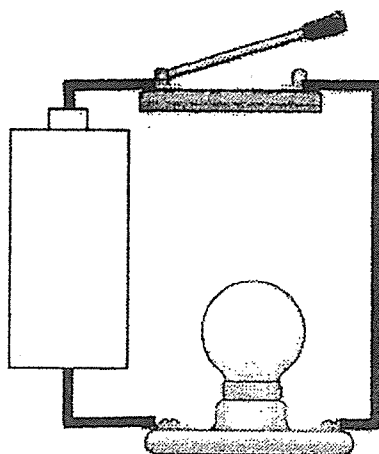

(a) Draw Raudah's circuit using circuit symbols in the space below. The battery has been drawn for you.

[2]

A large empty rectangular box provided for the student to draw the circuit using standard circuit symbols.

Score	2
-------	---

Raudah measured the brightness of the bulb using a light sensor. She repeated the experiment using different number of batteries and recorded her results in the table below.

Number of batteries	Brightness of the bulb (units)
1	1500
2	2500
3	3500
4	4500
5	0

(b) What is the aim of Raudah's Experiment? [1]

(c) Based on Raudah's results, what happened when five batteries were used? [1]

Score	2
-------	---

40. Shu Hui had four containers, J, K, L, and M of the same size but made of different materials. She put 100 g of ice into each container and placed the containers into a tank of water at 80°C at the same time.

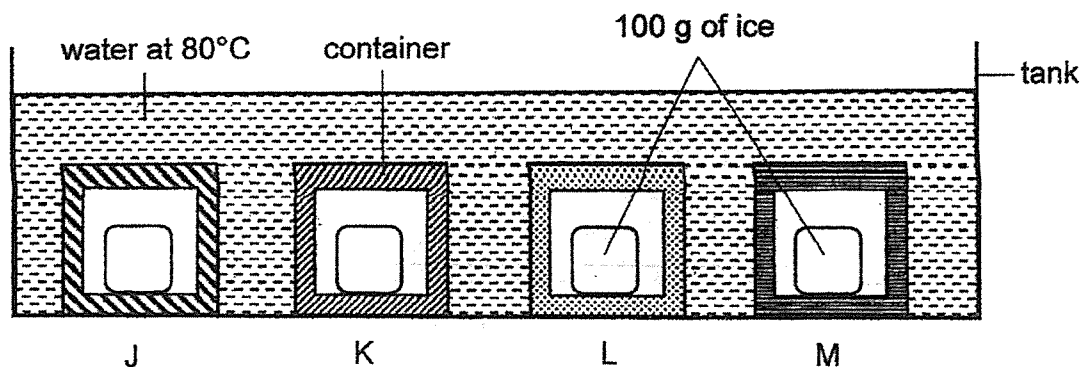

After 10 minutes, Shu Hui measured the mass of the ice left in each container and recorded her results in the table below.

Container	Mass of ice left (g)
J	25
K	40
L	80
M	30

- (a) Arrange the containers, J, K, L and M, starting from the poorest conductor of heat to the best conductor of heat. [1]

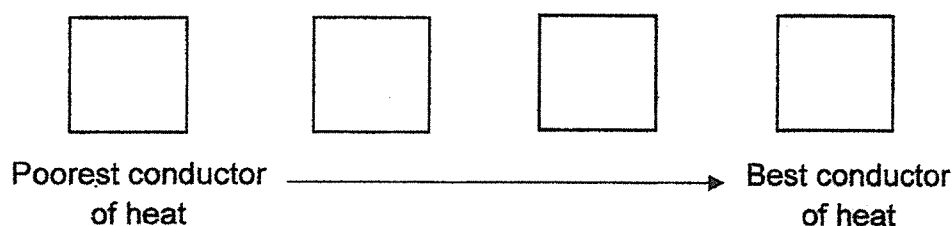

Wendy also used hot water at 80°C in a tank and 100 g of ice in each container J, K, L and M in a similar set-up as Shu Hui's experiment but the ice in her set-up melted faster.

- (b) What could Wendy have changed in her set-up? [1]

Score	2
-------	---

Then, Shu Hui emptied containers J and L and filled both fully with hot water at 90°C . She left them on a table at room temperature.

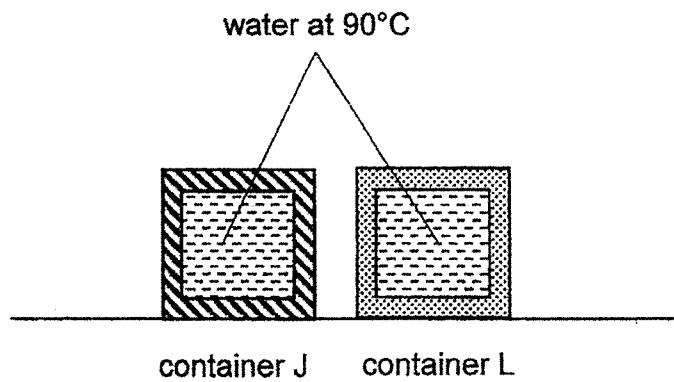

She measured the temperature of the water in both containers over a period of time and plotted the results in the graph as shown below.

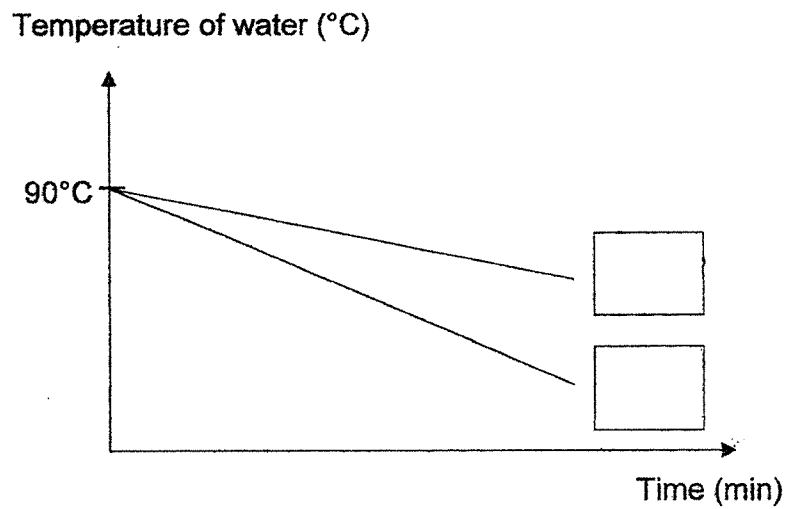

(c) Identify and fill in letters J and L in the boxes above.

[1]

End of Paper

Score	1
-------	---

ANSWER KEY

YEAR : 2021
LEVEL : PRIMARY 5
SCHOOL : TAO NAN
SUBJECT : SCIENCE
TERM : SA2

BOOKLET A

Q1	4	Q2	2	Q3	2	Q4	3	Q5	2
Q6	4	Q7	1	Q8	2	Q9	3	Q10	2
Q11	1	Q12	2	Q13	4	Q14	2	Q15	1
Q16	4	Q17	2	Q18	2	Q19	3	Q20	2
Q21	4	Q22	3	Q23	3	Q24	3	Q25	2
Q26	3	Q27	3	Q28	2				

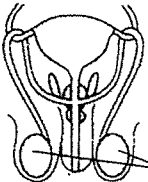
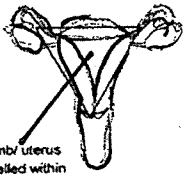
Qn	P5 Suggested Answers for EOY Science
29a	<div style="display: flex; justify-content: space-around; align-items: center;">  <div style="text-align: center;">(b) Testes/testis</div>  <div style="text-align: center;">(a) Womb/uterus (labelled within the marked area) [1]</div> </div>
29c	Ovary
30a	By animals
b	<p>The animals eat the fruit swallowing the seeds (c). The seeds are then passed out in their droppings (e1) away from the parent plant (e2).</p> <p>or</p> <p>The animals eat the fruit (c) and then throws the seeds (e1) away from the parent plant (e2).</p>
c	It increases the chance of the seeds germinating into new plants.
31a	Animal S does not have a 3-stage life cycle but animal T has a 3-stage life cycle. ("T is a 4-stage life cycle" is not based on the flowchart.)
b	<p>Any 2 characteristics:</p> <ul style="list-style-type: none"> - has a 3-stage life cycle - lays eggs - spends part of its life cycle in water
c	U
32a	Plant cell: P, R Animal cell: Q
b	Chloroplast/ cell wall
c	Organism S has chloroplast to help it make food.
33a	<p>Explanation on presence of warmer water vapour Water vapour in the air gained heat from the hot water. OR The hot water evaporated into water vapour.</p> <p>Explanation on Temperature difference & Condensation The water vapour touches the cooler surface of the mirror loses heat and condenses into water droplets.</p>

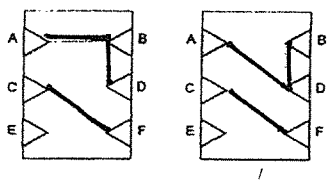
b	Letting down her hair increases the exposed surface area of the wet hair/ water in the hair to the surroundings. This increases the rate of evaporation of water . (Must make mention of <i>water</i> or <i>wet hair</i>)				
c	Windspeed: High		Temperature: High		
34a	Evaporation takes place at any temperature but boiling takes place at a fixed temperature/ boiling point. (Do not state 100 °C unless mention water)				
b	Water vapour				
c	Process Z				
d		Activity	Reduce	Reuse	Recycle
	(i)	Turning off the tap when brushing teeth.	✓		
	(ii)	Treating sewage water so that it can be used to wash our hands.			✓
35a	Distance between the jacket and the torch/ light sensor OR Brightness of the torch				
b	Jacket C. C reflects the most light (c) so drivers can see him most clearly (e). (Comparison)				
36a	As the height above sea level increases (decreases), the percentage of oxygen in the air decreases (increases).				
b	There is less oxygen in the air (c) hence, a person has to breathe faster to take in sufficient oxygen (e).				
c	C				
d	The heart rate starts to decrease at C because less oxygen and less food are sent to all parts of the body.				
37					
38a	Iron/ nickel/ steel/ cobalt				

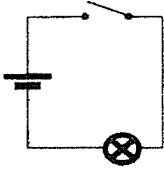
b	<p>Explanation on the circuit When the switch is closed, there is a closed circuit/ electricity can flow through the circuit (c1).</p> <p>Explanation on the magnetic attraction of P The iron bar becomes an electromagnet (e1) which would attract metal ball P (c1) as P is a magnetic material (e2)</p>
c	<p>Increase the number of coils of wire around the iron bar. or</p> <p>Increase the number of batteries used.</p>
39a	<p>Correct symbols – bulb, open switch. Correct sequence of arrangement of bulb, switch and wires. No gaps</p> 
b	<p>To find out how the number of batteries affect the brightness of the bulb OR To find out how many batteries will be needed to fuse a bulb.</p>
c	<p>The bulb fused/ was blown.</p>
40a	<p>L, K, M, J</p>
b	<p>Any of the following: Placed cloth/bubble wrap around the tank. Placed the set up at a location with a higher room temperature. Heated the tank of water using a burner <i>Crush the ice. (increase ESA)</i> <i>Used more water at 80°C (more heat energy)</i></p>
c	