

NANYANG PRIMARY SCHOOL

PRIMARY 5 SCIENCE

END-OF-YEAR EXAMINATION

27 OCTOBER 2021

BOOKLET A

Total duration for Booklets A and B: 1 h 45 min

Name: _____ ()

Class: Primary 5 ()

**DO NOT OPEN THIS BOOKLET UNTIL YOU ARE TOLD TO DO SO.
FOLLOW ALL INSTRUCTIONS CAREFULLY.**

Booklet A consists of 18 printed pages including this cover page.

Section A: Multiple Choice Questions [56 marks]

For each question from 1 to 28, four options are given. One of them is the correct answer. Indicate your choice in this booklet and shade the correct oval (1, 2, 3 or 4) on the Optical Answer Sheet provided.

1. Which one of the following diagrams correctly shows the development of a flowering plant?

(1)

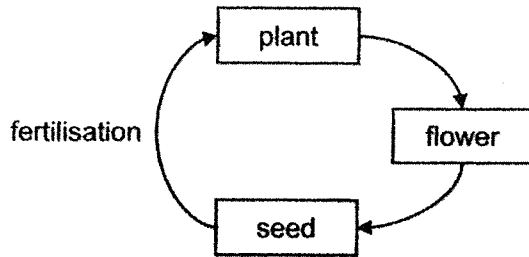

(2)

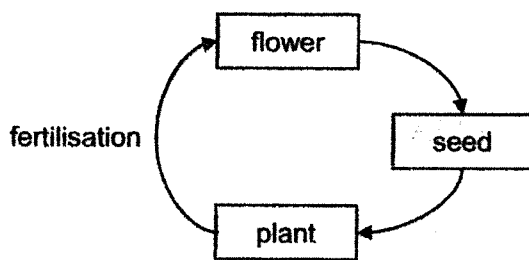

(3)

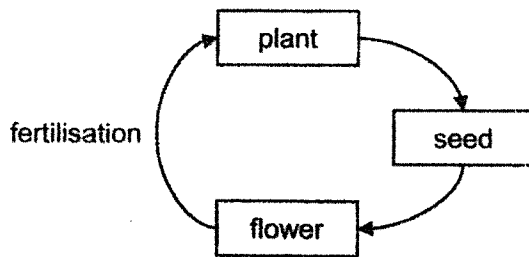

(4)

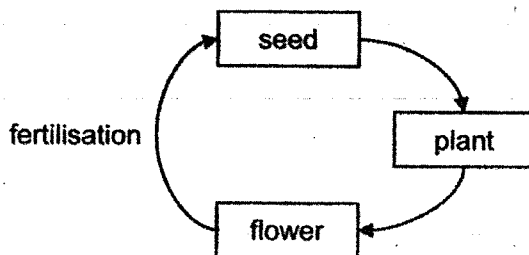

2. Which one of the following correctly states the male and female reproductive cells in humans?

	Male reproductive cell	Female reproductive cell
(1)	sperm	egg cell
(2)	pollen grains	ovules
(3)	pollen grains	egg cell
(4)	sperm	ovules

3. Susan cut out the food-carrying tubes of a plant. One week later, she observed the plant and drew her observation in the diagram shown below.

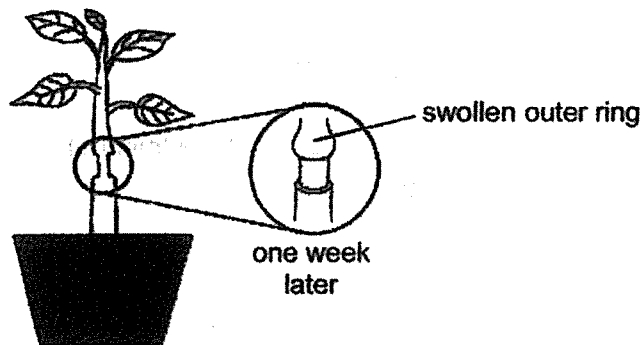

Which one of the following correctly explains her observation of the stem after one week?

- (1) Food cannot be transported from the roots to the leaves so food is stored at the part of the stem above the cut.
- (2) Food cannot be transported from the leaves to the roots so food is stored at the part of the stem above the cut.
- (3) Water cannot be transported from the roots to the leaves so water is stored at the part of the stem above the cut.
- (4) Water cannot be transported from the leaves to the roots so water is stored at the part of the stem above the cut.

4. The graph below shows the changes in Joshua's heart rate before, during and after running. He was running at the same speed throughout.

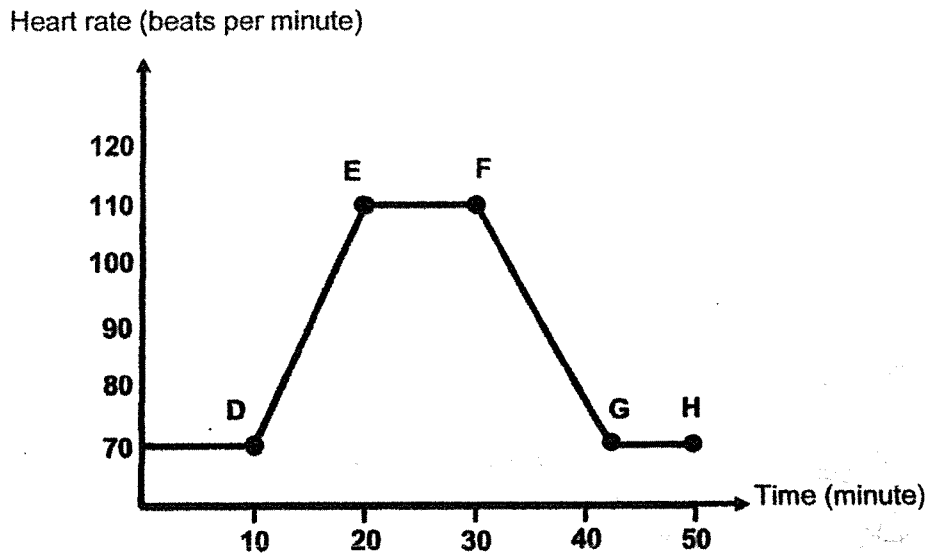

At which points did Joshua start and stop running?

	Started running	Stopped running
(1)	Point D	Point F
(2)	Point D	Point G
(3)	Point E	Point F
(4)	Point F	Point H

5. Study the diagram of the cell below carefully.

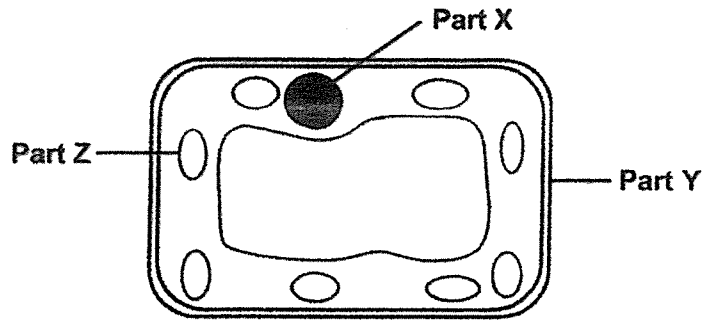

Which of the following shows the correct function of parts, X, Y and Z?

	Part X	Part Y	Part Z
(1)	controls all the activities in the cell	contains chlorophyll that traps light to make food	supports and gives the cell a regular shape
(2)	contains chlorophyll that traps light to make food	supports and gives the cell a regular shape	controls all the activities in the cell
(3)	supports and gives the cell a regular shape	controls all the activities in the cell	contains chlorophyll that traps light to make food
(4)	controls all the activities in the cell	supports and gives the cell a regular shape	contains chlorophyll that traps light to make food

6. Thomas observed the life cycle of an insect over some time and recorded his observations in the diagram shown below.

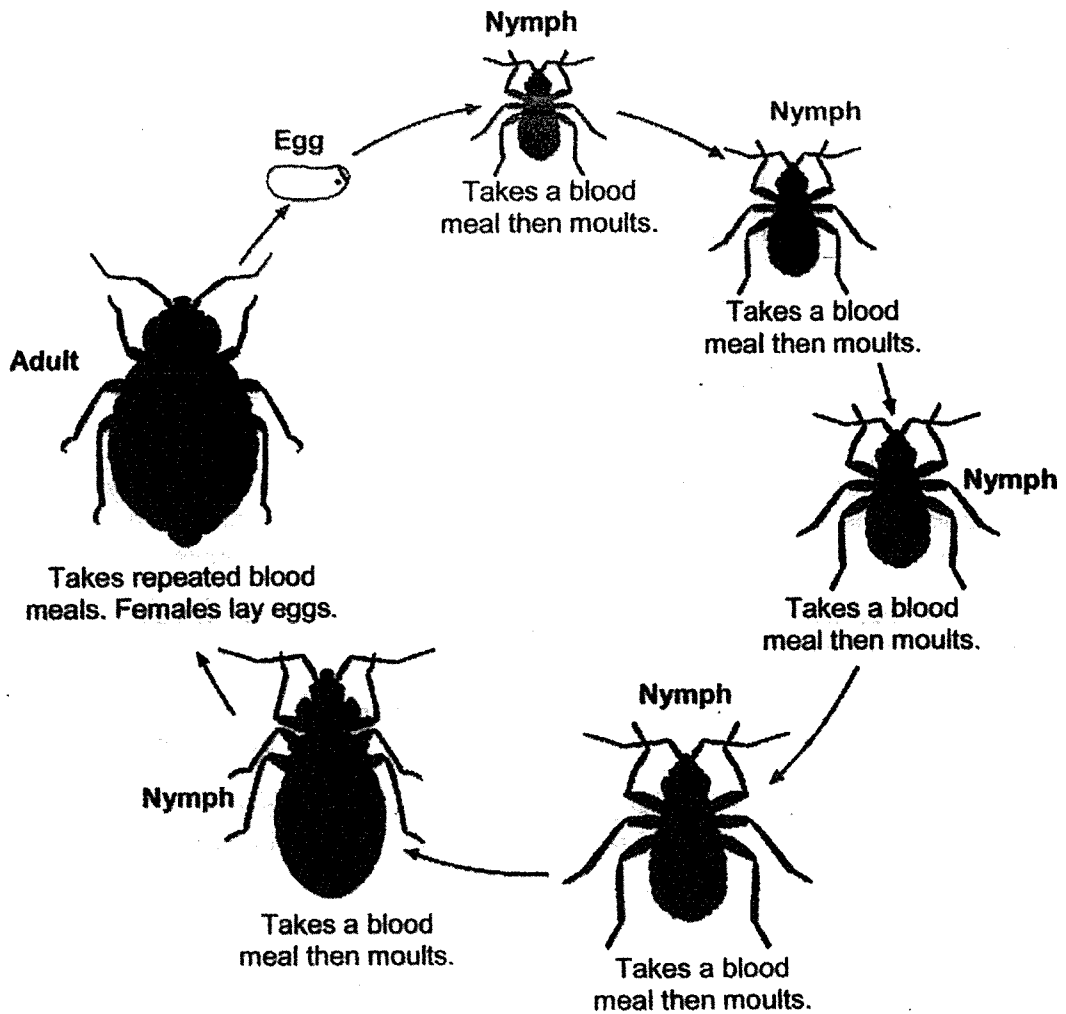

Based on his observations, he made the following statements.

- A The insect reproduces by laying eggs.
- B The insect moults during its nymph stage.
- C The insect takes five blood meals before it becomes an adult.

Which of his statement(s) is/are correct?

- (1) B only
- (2) A and C only
- (3) B and C only
- (4) A, B and C

7. The life cycle of a plant is shown in the diagram below.

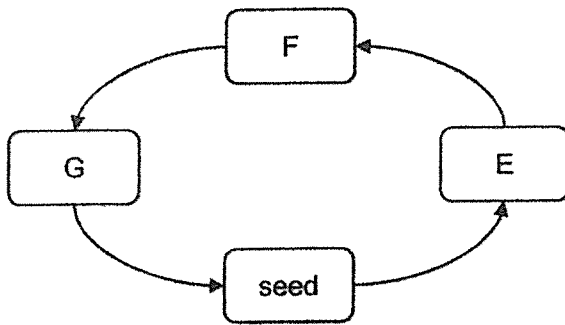

Which of the following correctly describes the possible observations at stages E, F and G?

	E	F	G
(1)	fruit appears	flower appears	root and shoot appear
(2)	root and shoot appear	fruit appears	flower appears
(3)	root and shoot appear	flower appears	fruit appears
(4)	flower appears	root and shoot appear	fruit appears

8. The diagram below represents the human digestive system.

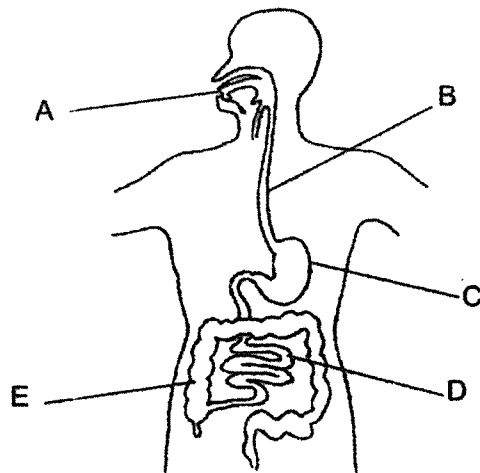

Which parts of the digestive system produce digestive juices?

- (1) B and D only
- (2) A, B and E only
- (3) A, C and D only
- (4) C, D and E only

9. Geraldine made the following statements about the functions of the human skeletal system.

- A It gives the body its shape. ✓
- B It protects some organs in the body. ✓
- C It carries digested food to all parts of the body.
- D It works with the muscular system to enable the body to move. ✓

Which of the statements made by Geraldine are true?

- (1) A and B only
- (2) C and D only
- (3) A, B and D only
- (4) A, C and D only

10. Study the diagram below. P, Q, R and S represent four different processes that involve changes in the state of water.

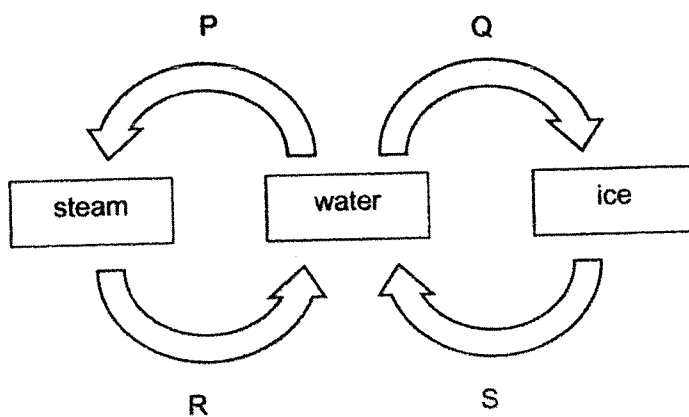

Which of these processes, P, Q, R or S, take place at a fixed temperature?

- (1) P and R only
- (2) P, Q and S only
- (3) Q, R and S only
- (4) P, Q, R and S

11. Lindy set up an experiment to collect water in the basin, as shown in the diagram below. She placed the set-up under the sun for two hours.

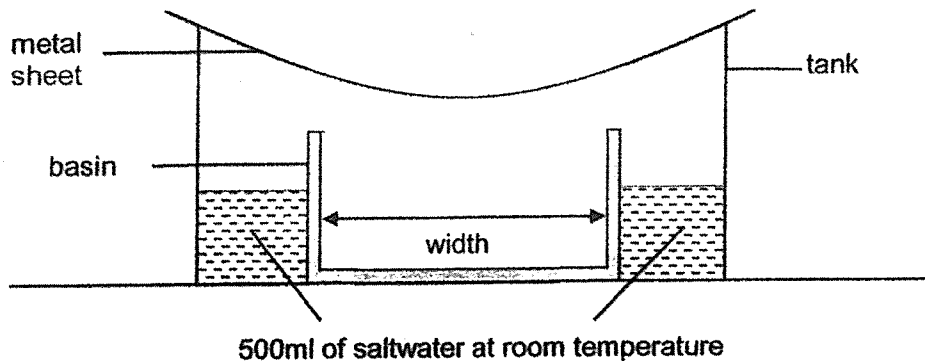

She observed that there was 100ml of water collected in the basin after two hours.

Which one of the following changes to the set-up will enable Lindy to collect the most amount of water in the basin?

- (1) Increase the width of the basin.
 - (2) Decrease the width of the basin.
 - (3) Increase the amount of saltwater.
 - (4) Decrease the amount of saltwater.
12. Study the diagram of the water cycle below.
X and Y are two processes that take place in the water cycle.

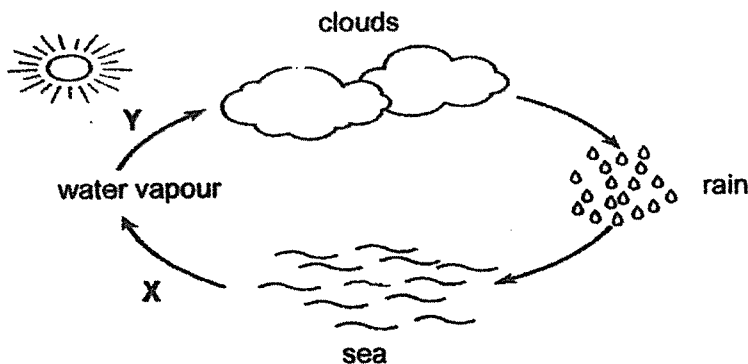

Which of the following statements about the water cycle are correct?

- A The water vapour lost heat during process Y.
 - B Process X does not take place at a fixed temperature
 - C There is a change in the state of water during process X.
 - D Process Y occurs when there is a temperature difference.
- (1) A and D only
 - (2) A, B and C only
 - (3) B, C and D only
 - (4) A, B, C and D

13. Which one of the following actions help to conserve water?

- (1) Using a hose to wash the car.
- (2) Switching off the fan when not in use.
- (3) Using running water from the tap to rinse your mouth.
- (4) Taking a 5 minute shower instead of a bath in the fully-filled bathtub.

14. Sophie set up 4 circuits, A, B, C and D, with identical bulbs and working batteries as shown below.

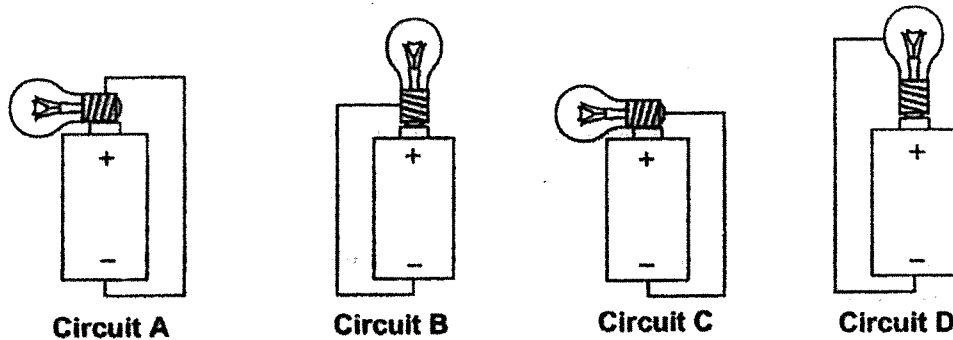

In which of the above circuits will the bulb light up?

- (1) A and D only
 - (2) B and C only
 - (3) A, B and C only
 - (4) B, C and D only
15. A circuit is set up using 2 new batteries, 3 working identical bulbs, B1, B2 and B3 and 3 switches, S and S2, as shown in the diagram below.

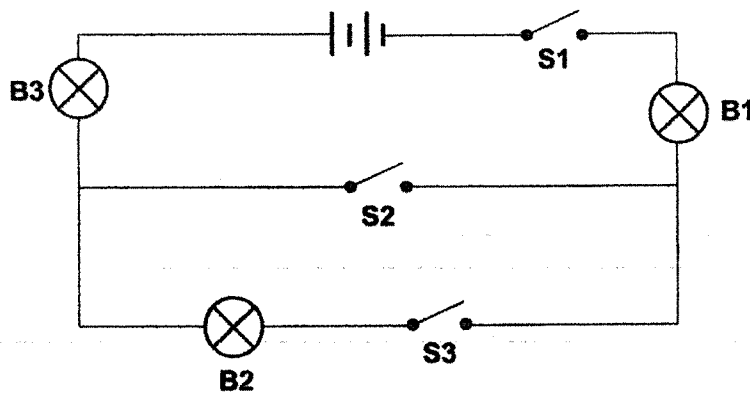

Which of the following will allow only B1 and B3 to light up?

	S1	S2	S3
(1)	open	closed	closed
(2)	open	open	closed
(3)	closed	open	open
(4)	closed	closed	open

16. Jamal set up a circuit as shown below.

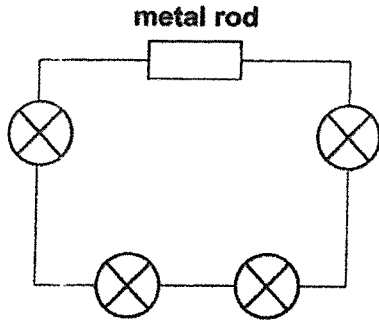

He observed that all the bulbs did not light up.

Which of the following shows why all the bulbs in Jamal's circuit did not light up?

- (1) There is no switch in the circuit.
- (2) There is no battery in the circuit.
- (3) The metal rod is an electrical insulator.
- (4) There are too many bulbs in the circuit.

17. Jeremiah set up a circuit as shown below using 2 new batteries, a switch and 3 bulbs. Objects, X, Y and Z, were made of different materials.

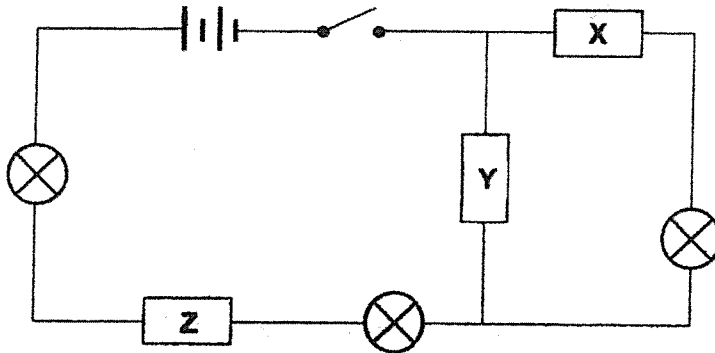

When he closed the switch, he observed that only 2 bulbs lit up.

Which of the following correctly shows the most likely materials used to make objects, X, Y and Z?

	Object X	Object Y	Object Z
(1)	steel	wood	plastic
(2)	copper	iron	steel
(3)	wood	copper	iron
(4)	plastic	steel	wood

20. Mei Li set up the circuit as shown below.

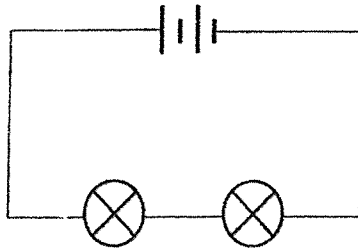

Which of the following can Mei Li do to increase the brightness of the bulbs?

- A Remove one battery.
- B Add one more bulb in series.
- C Add one more battery in series.
- D Arrange the bulbs in parallel to each other.

- (1) A and C only
- (2) C and D only
- (3) B, C and D only
- (4) A, B, C and D

21. Ahmad set up 4 circuits with different arrangements of working identical bulbs and batteries. All the bulbs lit up.

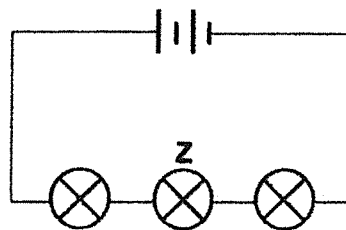
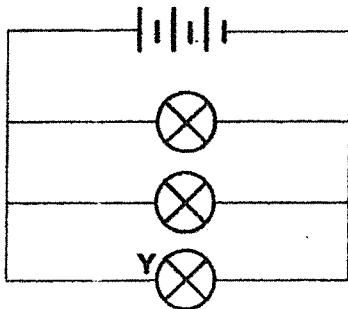
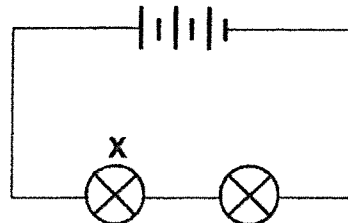
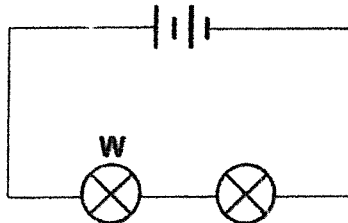

Which one of the following shows the correct arrangement of the bulbs from the dimmest to the brightest?

	Dimmest	→	Brightest
(1)	W,	X,	Y, Z
(2)	X,	Z,	W, Y
(3)	Y,	X,	W, Z
(4)	Z,	W,	X, Y

22. Pei Xin made the following statements.

- A Put many plugs into one socket.
- B Use electrical equipment with exposed wires.
- C Do not touch the switch when your hands are wet.
- D Never try to repair any faulty electrical equipment yourself.

Which of the statements she made are examples of using electricity safely?

- (1) A and B only
- (2) C and D only
- (3) A, C and D only
- (4) A, B, C and D

23. Study the flowchart below.

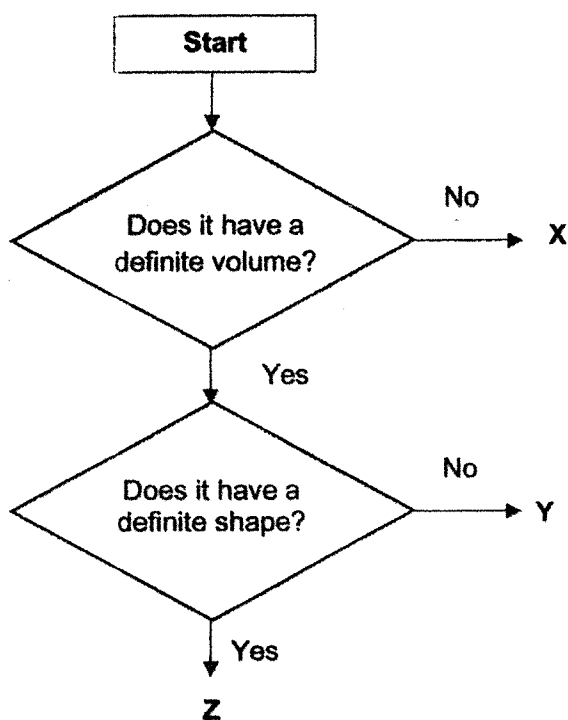

Based on the above flowchart, which one of the following best represents X, Y and Z?

	X	Y	Z
(1)	coffee	eraser	water vapour
(2)	book	oil	shadow
(3)	oxygen	milk	marble
(4)	shadow	water vapour	tea

24. John filled a container with water as shown in Figure A below. He then gently lowered a rock into the container and the water that overflowed from it was collected in a measuring cylinder as shown in Figure B.

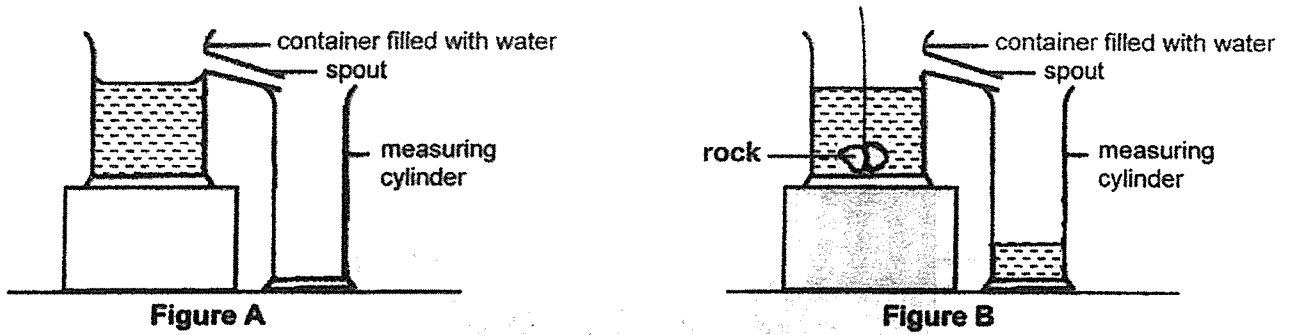

Based on the above experiment, which one of the following can John conclude?

- (1) Matter has mass.
- (2) Matter occupies space.
- (3) Solids have a definite shape.
- (4) Liquids cannot be compressed.

Study the diagram below and answer Questions 25 and 26.

The diagram below shows Mr Rahim performing a puppet show. Shadows of the puppets are cast on the screen and the audience watches the puppet show from the other side of the screen.

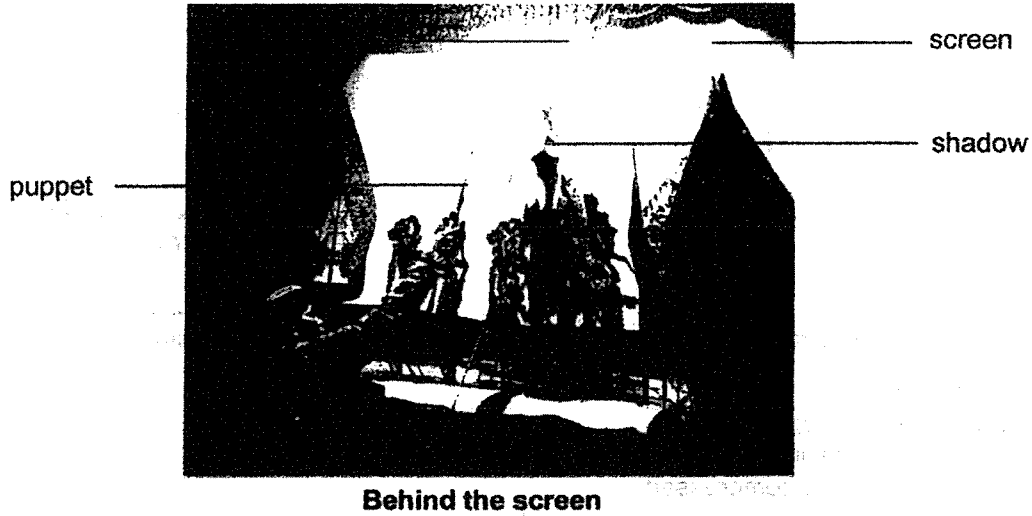

Using different materials for his puppets, Mr Rahim formed dark shadows and different colour shadows.



25. Which of the following explains how the dark shadows and different coloured shadows were formed?

	Allows some light to pass through	Does not allow light to pass through
(1)	screen	puppet
(2)	puppet	screen
(3)	puppet and screen	puppet
(4)	puppet	puppet and screen

26. Mr Rahim changed the size of the shadows by changing the distance between the puppet, the screer and the light source.

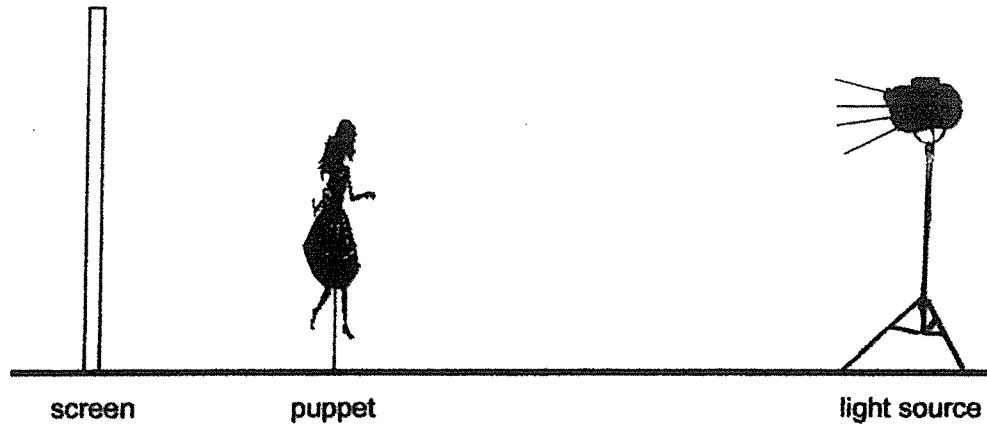

Which of the following action(s) would allow Mr Rahim to form a bigger shadow of the puppet on the screen?

- P Move the puppet closer to the screen.
- Q Move the puppet closer to the light source.
- R Move the light source further away from the puppet.

- (1) P only
- (2) Q only
- (3) P and R only
- (4) Q and R only

27. Viknash put some ice cubes on a metal tray as shown in the diagram below.

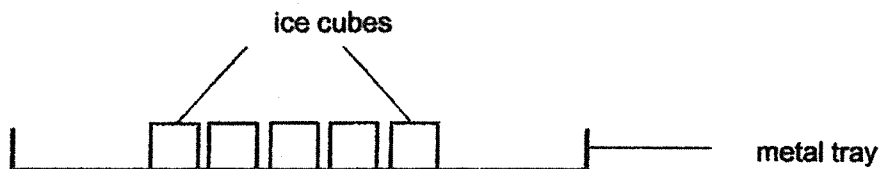

After 10 minutes, he observed that the ice cubes had melted and the metal tray felt cold.

Which of the following statements correctly explain Viknash's observations?

- A The metal tray lost heat to the ice cubes.
- B The ice cubes lost heat to the metal tray.
- C The ice cubes gained heat from the surroundings.

- (1) A only
- (2) B only
- (3) A and B only
- (4) A and C only

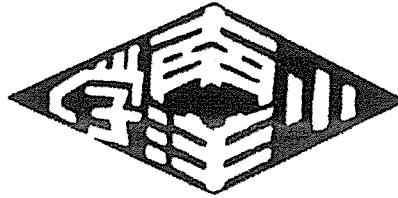

**NANYANG PRIMARY SCHOOL
PRIMARY 5 SCIENCE
END-OF-YEAR EXAMINATION**

27 OCTOBER 2021

BOOKLET B

Total duration for Booklets A and B: 1 h 45 min

Name: _____ ()

Class: Primary 5 ()

Marks Scored:

Booklet A:		56
Booklet B:		44
Total:		100

Any query on marks awarded should be raised by the next day. We seek your understanding in this matter as any delay in the confirmation of marks will lead to delays in the generation of results.

Parent's signature:

**DO NOT OPEN THIS BOOKLET UNTIL YOU ARE TOLD TO DO SO.
FOLLOW ALL INSTRUCTIONS CAREFULLY.**

Booklet B consists of 15 printed pages including this cover page.

Section B: Open-Ended Questions [44 marks]

Write your answers to Questions 29 to 40 in the spaces provided.

29. The graph below shows the amount of oxygen found in blood samples taken from four different blood vessels P, Q, R and S in the human body.

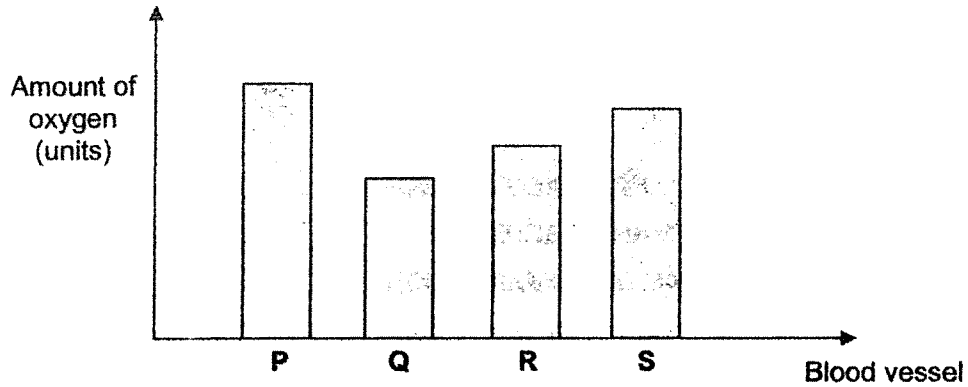

- (a) Based on the results, label the circles in the diagram below with the blood vessels, P, Q, R and S to show the correct movement of blood. Each letter can only be used once. [2]

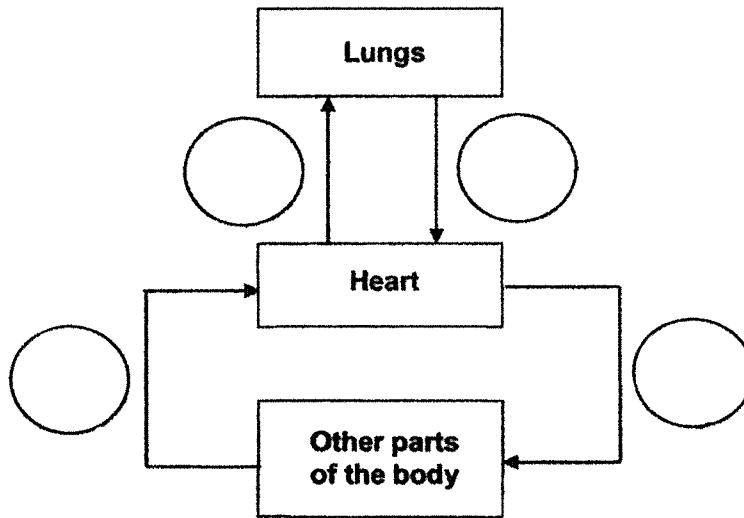

- (b) State the function of the heart in the circulatory system. [1]

- (c) Explain why the heart rate of a person increases when he exercises. [1]

30. Amy conducted an experiment to measure the amount of oxygen present in the water of her fish tank at different temperatures. She counted the breathing rate of the fish by the number of times the gill covers opened and closed. Her results are shown in the graph below.

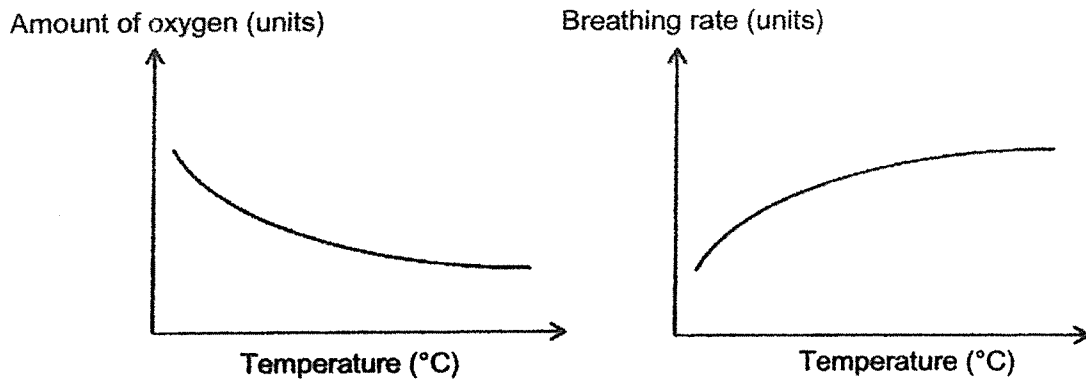

- (a) State the organ that fishes use to take in dissolved oxygen from the water. [1]

- (b) She observed that the breathing rate of her fish increased as the temperature of the water in the fish tank increased. Give a reason for this observation. [2]

- (c) Which variable did Amy change in her experiment? [1]

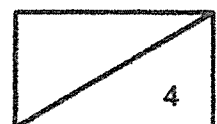

31. The following diagram shows the different parts of a flower.

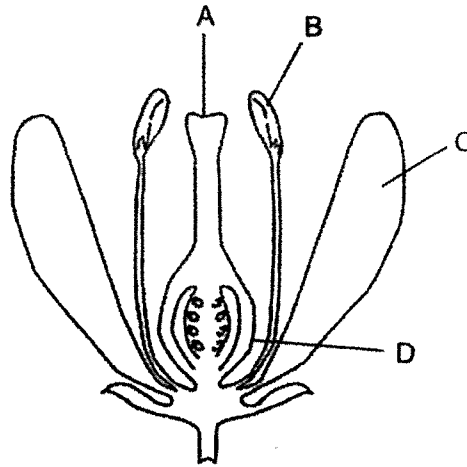

Alice conducted an experiment with three flowers, X, Y and Z, from the same plant. She removed different flower parts from the three flowers as shown in the table below. The flower had not been pollinated before the parts are removed.

Flower	Parts removed
X	A and D
Y	B and C
Z	A, C and D

(a) State all the flower(s), X, Y or Z, that will definitely **not develop** into a fruit. Explain your answer. [2]

(b) In the diagram below, draw an arrow to show how pollination takes place in the flower. [1]

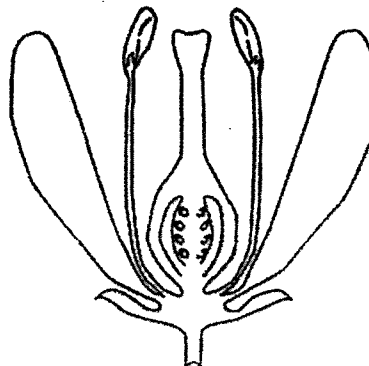

The diagram below show the human male and female reproductive systems.



(c) On the diagram above, mark with an 'X' the part of the human reproductive system that carries out the same function as part B in the diagram shown on page 4. [1]

(d) Describe how fertilisation takes place in humans. [1]

32. The diagram below shows the life cycles of insects R and S.

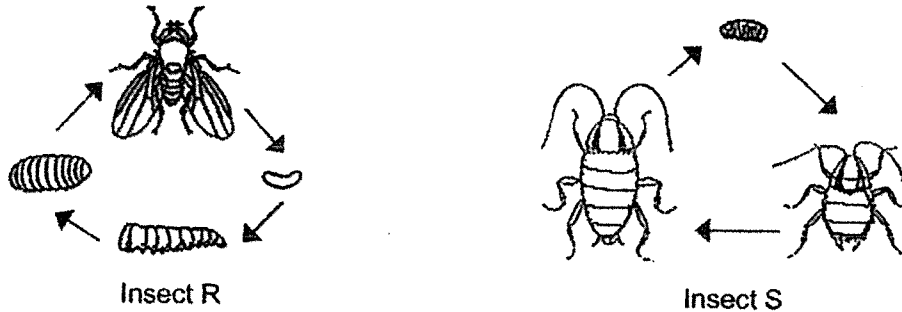

(a) Classify the two insects by writing R and S in the correct boxes provided below. [1]

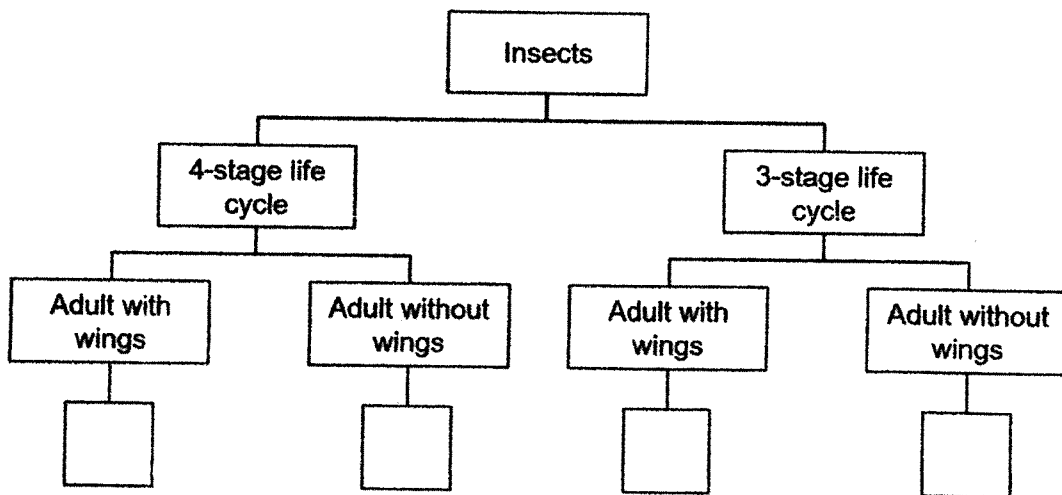

(b) Based only on your observations of the life cycles of insects R and S, state another difference between the young and adult of insects R and S that is not stated in the classification chart shown. [1]

(c) State two similar characteristics between insects R and S. [2]

Similarity 1: _____

Similarity 2: _____

33. The graph below shows the changes in the mass of a young plant and its seed leaves during germination.

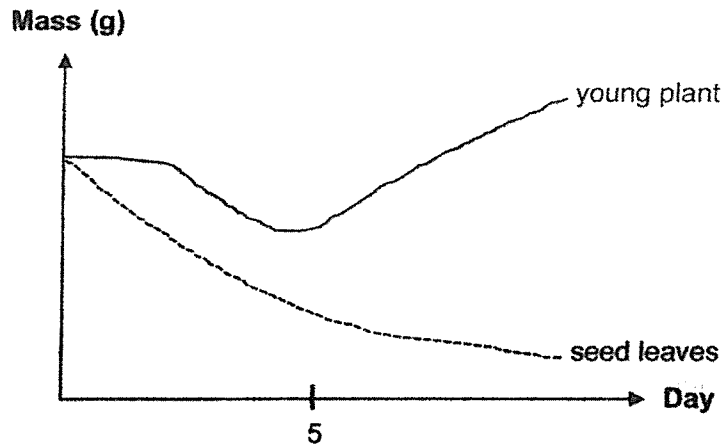

- (a) State how the mass of the seed leaves changes over time. Explain why. [2]

- (b) Explain why the mass of the young plant increased after day 5? [1]

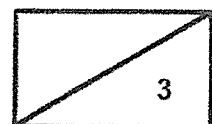

34. The table below shows the amount of undigested food found leaving the different parts, V, W, X, Y and Z of Peter's digestive system. Digestion starts when Peter chews his food at part V before swallowing.

Mass of undigested food leaving the different parts (g)				
V	W	X	Y	Z
100	(a) _____	80	30	30

- (a) Write, in the table above, the most likely mass of the undigested food leaving part W of Peter's digestive system. [1]
- (b) Identify part Z. Explain why the amount of undigested food remained the same as it moved from part Y to Z. [1]

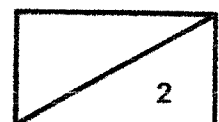

35. The diagram below shows the human digestive system.

(a) Label the organs in the boxes (i), (ii), (iii) and (iv) provided below. [2]

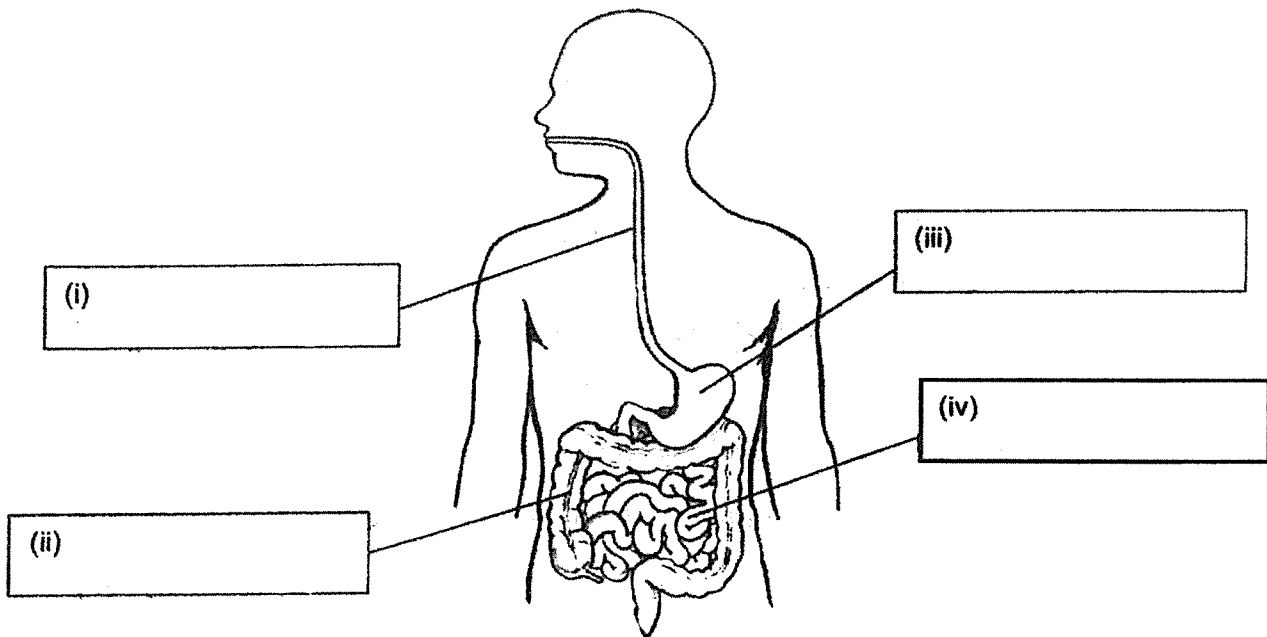

The digestive system and circulatory system work together in the small intestine.

(b)(i) Describe what happens to the digested food in the small intestine. [1]

(b)(ii) Describe the function of the circulatory system in the small intestine. [1]

36. Mary took a beaker of ice cubes and placed it on a table at room temperature as shown in the diagram below.

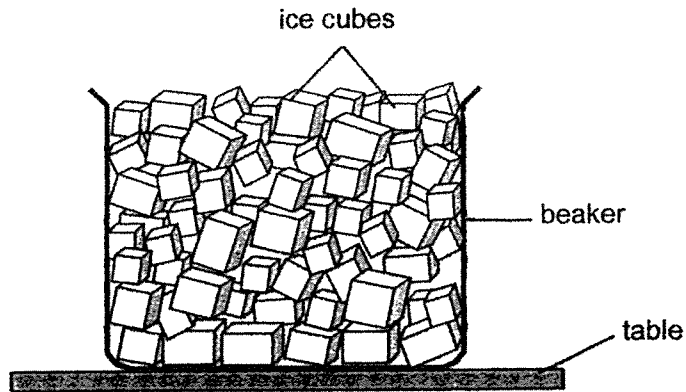

After two minutes, Mary noticed some water droplets forming.

- (a) Draw and label in the diagram above where the water droplets were formed after two minutes.

- (b) Explain how the water droplets were formed.

- (c) Explain why the water droplets could not be seen after some time.

37. Maryam set up a circuit with 3 working batteries, 4 switches, S1, S2, S3 and S4, and 4 identical bulbs, W, X, Y and Z, as shown below.

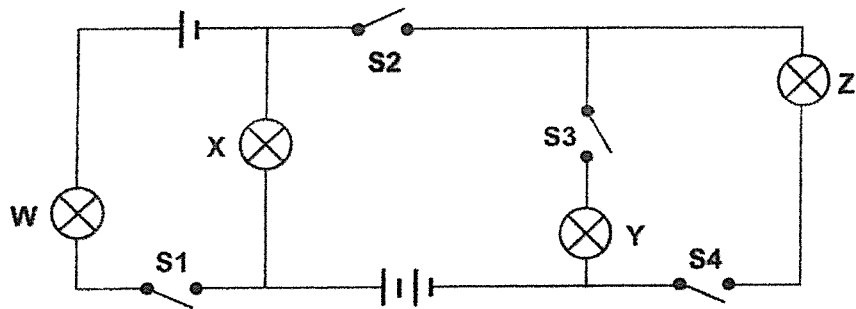

- (a) State the switch(es) that must be closed in order for only bulbs, X, Y and Z to light up. [1]

Maryam then made a circuit card with 6 contact points, P, Q, R, S, T and U, using steel clips. The wires under the circuit card are not shown.

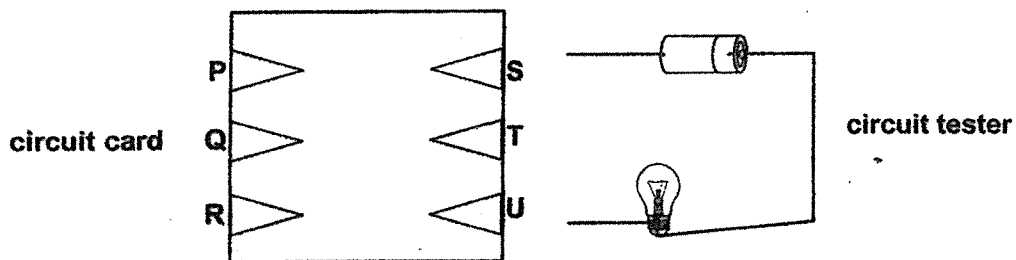

She then connected the circuit tester to different pairs of contact points on the circuit card to see if the bulb lights up. She recorded the results in the table below.

Points connected to the circuit tester	Did the bulb light up?
P and S	Yes
R and T	No
Q and R	Yes
R and S	Yes
Q and U	No

- (b) Based on the results above, draw the lines to represent the wires that connect the contact points under the circuit card in the diagram below. [1]

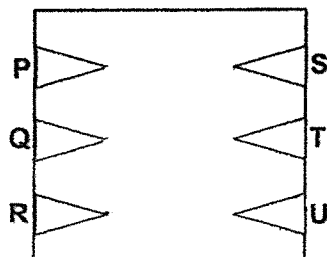

38. Sebastian set up a circuit with 2 working batteries, 3 identical bulbs, X, Y and Z, and strip M, as shown below. He observed that all the bulbs were lit up when the switch was closed.

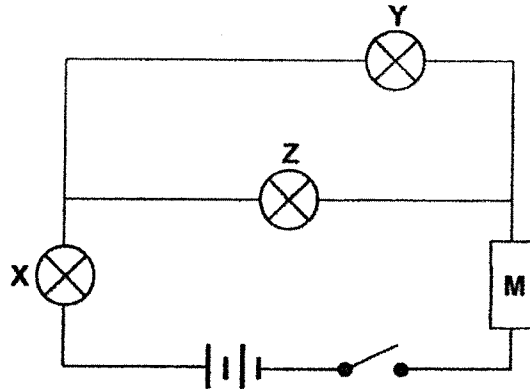

- (a) What material is strip M most likely made of? Explain your answer. [1]

A few days later, he observed that all the bulbs did not light up. He tested the electrical components and found out that the batteries and 2 of the bulbs were in working condition. He concluded that 1 of the bulbs had fused.

- (b)(i) Identify which one of the bulbs had fused. [1]

- (b)(ii) Explain why the rest of the working bulbs could not light up when the bulb you had identified fused. [1]

39. Hui Ling set up 2 circuits, J and K, using the same number of batteries and identical bulbs.

In circuit J, she used one arrangement of bulbs. She changed the number of bulbs in the circuit before measuring its brightness using the data logger.

In circuit K, she used a different arrangement of bulbs. She also changed the number of bulbs in the circuit before measuring its brightness using the data logger.

She then recorded the brightness of the bulbs in both circuits in the table below.

	Number of bulbs			
	1	2	3	4
Brightness of bulbs in Circuit J (units)	30	15	X	7.5
Brightness of bulbs in Circuit K (units)	30	30	30	30

(a) Based on the information above, state the aim of Hui Ling's experiment? [1]

(b) What is a possible reading of X? [1]

_____ units

(c) Based on the results above, how did Hui Ling arrange the bulbs in both Circuits J and K? [1]

Circuit	Arrangement
J	
K	

(d) Suggest one change to the circuit that Hui Ling can do to increase the brightness of the bulbs in circuit K without removing any bulb from the circuit. Explain your answer. [2]

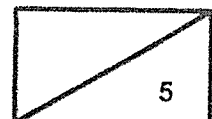

40. Evelyn made an electromagnet as shown in the diagram below.

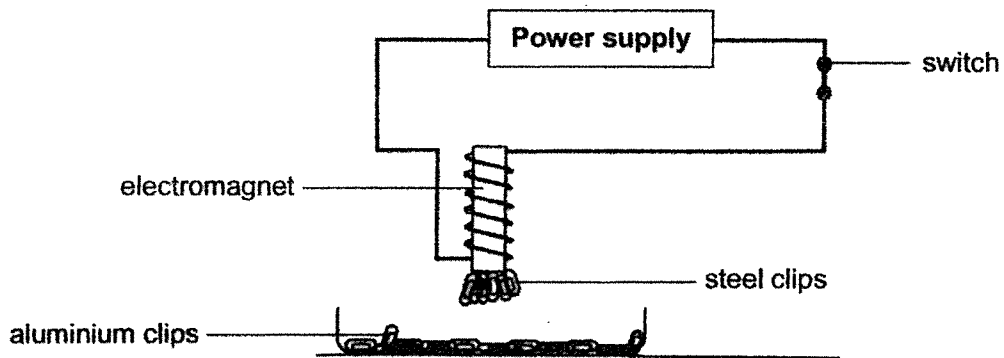

She tested the magnetic strength of the electromagnet and recorded her results in the table below.

	Aluminium clips	Steel clips
Number of clips attracted	0	5

(a) Give a reason why the electromagnet did not attract any aluminium clips. [1]

(b) Without changing the distance between the electromagnet and the steel clips, suggest a way Evelyn could have her electromagnet attract more steel clips. [1]

(Continue Question 40)

The diagram below shows the electromagnetic door lock in Evelyn's office.

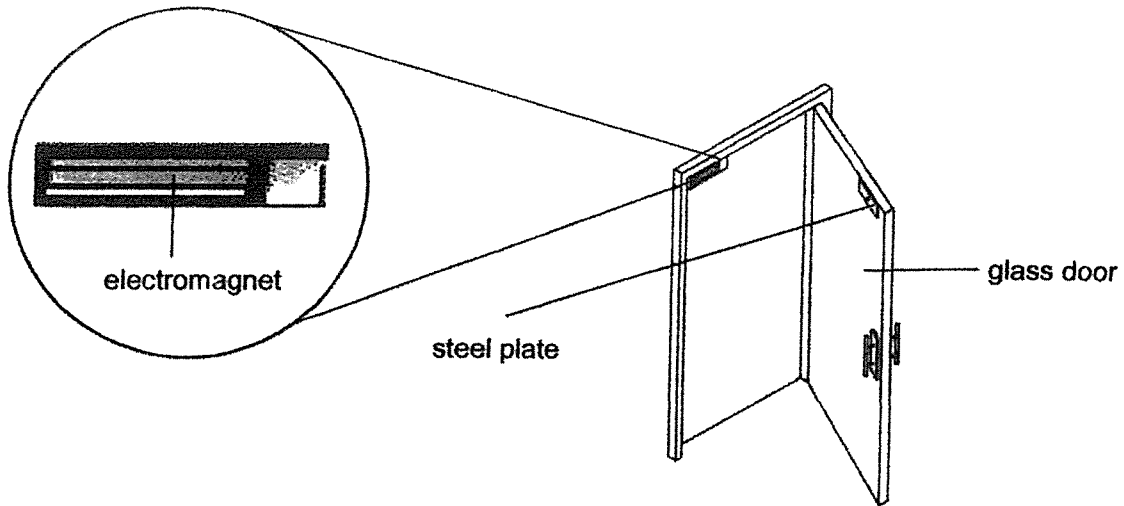

- (c) Explain how the electromagnetic door lock above works when Evelyn presses a switch to open the glass door. [2]

~ END OF BOOKLET B ~

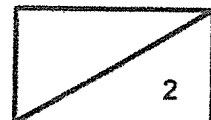

**Nanyang Primary School
P5 SCIENCE END OF YEAR EXAM 2021
SUGGESTED ANSWER KEY**

Section A

1	4	11	2	21	4
2	1	12	4	22	2
3	2	13	4	23	3
4	1	14	2	24	2
5	4	15	4	25	3
6	4	16	2	26	2
7	3	17	3	27	4
8	3	18	1	28	1
9	3	19	4		
10	2	20	2		

Section B

Qn	Answer
29(a)	
29(b)	The heart pumps blood to all parts of the body.
29(c)	The heart pumps blood rich in digested food/ oxygen to the different parts of her body faster. OR The heart pumps blood rich in carbon dioxide/ wasted materials away from the different parts of her body faster.
30(a)	Gills
30(b)	The amount of oxygen in the water decreased so the fishes breathed faster to take in more/ enough oxygen.
30(c)	Temperature of water
31(a)	Flower X and Z. The stigma/ A and the ovary/ D have been removed so pollination and fertilization cannot take place.
31(b)	
31(c)	
31(d)	A sperm / male reproductive cell fuses with an egg / female reproductive cell.

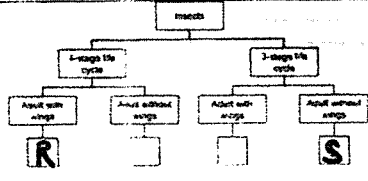
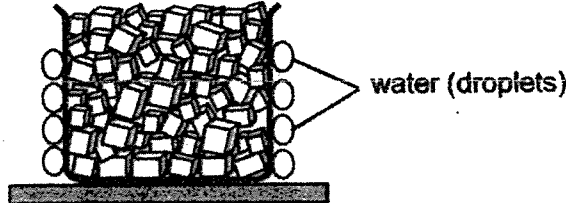
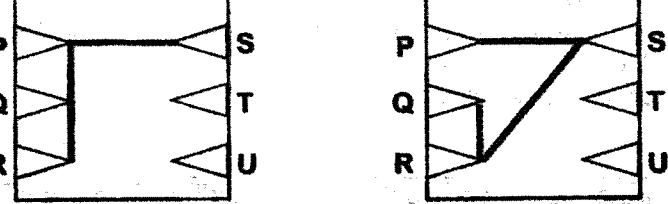
32(a)	
32(b)	The young of insect R does not look like the adult but the young of insect S looks like the adult.
32(c)	Two similarities: Any 2 (have three body parts/ have six legs/ have hard outer covering/ lay eggs/ have egg stage/ have feelers/ moult)
33(a)	The mass of the seed leaves decrease as the seedling used the (stored) food/ nutrients in the seed leaves.
33(b)	The plant has leaves to make food.
34(a)	100
34(b)	Z is the large intestine. There is no digestion occurring in Part Z.
35(a)	(i) gullet (iii) stomach (ii) large intestine (iv) small intestine
35(bi)	Digested food is absorbed into the blood(stream).
35(bii)	The circulatory system transports the digested food/ nutrients to all parts of the body.
36(a)	
36(b)	Warmer (surrounding) water vapour comes into contact with the cooler (outer) surface of the beaker, lost heat and condense into water droplets.
36(c)	The water (droplets) gained heat (from the surrounding air) and evaporated.
37(a)	S2, S3 and S4
37(b)	
38(a)	Metal/ Steel/ Copper/ Iron. It is an electrical conductor.
38b(i)	Bulb X
38(bii)	When bulb X is fused, it becomes an open circuit so electricity cannot flow through.
39 (a)	To find out how the arrangement of bulbs affects the brightness of the bulbs.
39(b)	7.5 < X < 15 units
39(c)	J- Series K- Parallel
39(d)	Increase the number of batteries connected to the circuit so more electricity is flowing through each bulb.
40(a)	Aluminium is a non-magnetic material.
40(b)	Increase the number of coils of wire around the electromagnet. OR Increase the number of batteries used.
40(c)	When the switch is pressed, the electric circuit is opened so electricity could not flow through the circuit. The electromagnet is no longer magnetic so it does not attract the steel plate on the door.

END