



**NAN HUA PRIMARY SCHOOL  
END-OF-YEAR EXAMINATION 2021  
PRIMARY 5**

**SCIENCE**

**BOOKLET A**

**28 Multiple Choice Questions (56 marks)**

**Total Time for Booklets A and B : 1 hour 45 minutes**

**INSTRUCTIONS TO CANDIDATES**

1. Write your name and index number in the space provided.
2. Do not turn over the page until you are told to do so.
3. Follow all instructions carefully.
4. Answer all questions.
5. Shade your answers in the Optical Answer Sheet (OAS) provided.

**Marks Obtained**

<b>Booklet A</b>		<b>/ 56</b>
<b>Booklet B</b>		<b>/ 44</b>
<b>Total</b>		<b>/ 100</b>

**Name:** \_\_\_\_\_ (       )       **Class:** P 5 S \_\_\_\_\_

**Date:** 27 October 2021

**Parent's Signature:** \_\_\_\_\_

**Section A: (28 × 2 marks = 56 marks)**

For each question from 1 to 28, four options are given. One of them is the correct answer. Make your choice (1, 2, 3 or 4) and shade your answer on the Optical Answer Sheet.

1 The diagram below shows parts of a plant.

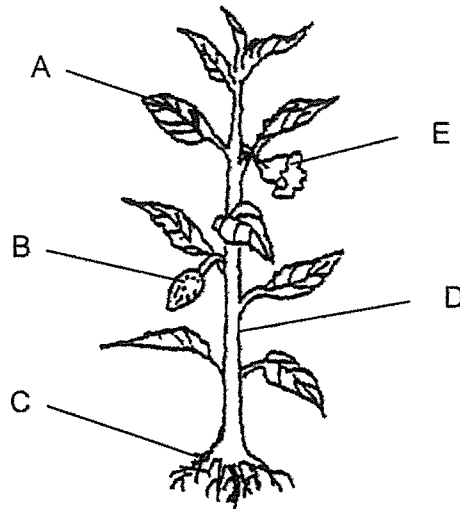

Plants take in water and carbon dioxide to make food in the presence of sunlight. Which of the following are plant parts that need to work together for the plant to make food?

- (1) A and E only
- (2) A, C and D only
- (3) A, C and E only
- (4) B, C and D only

2 Study the classification chart and the three animals, P, Q and R.



P

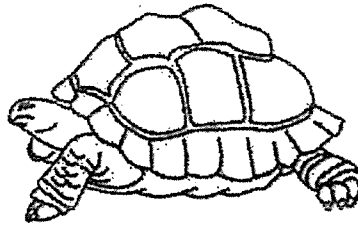

Q



R

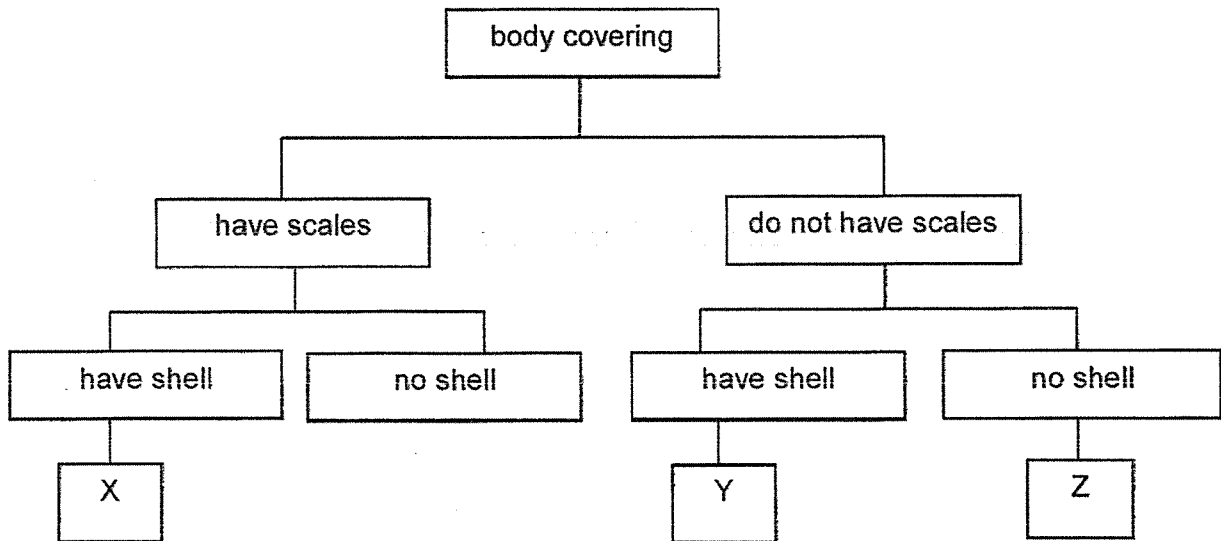

Which of the following shows the correct classification of animals P, Q and R in boxes X, Y and Z?

	X	Y	Z
(1)	Q	P	R
(2)	Q	R	P
(3)	R	P	Q
(4)	R	Q	P

3 Which organ in the digestive system does the absorption of digested food take place?

- (1) gullet
- (2) stomach
- (3) small intestine
- (4) large intestine

4 The diagram shows part of the human body.

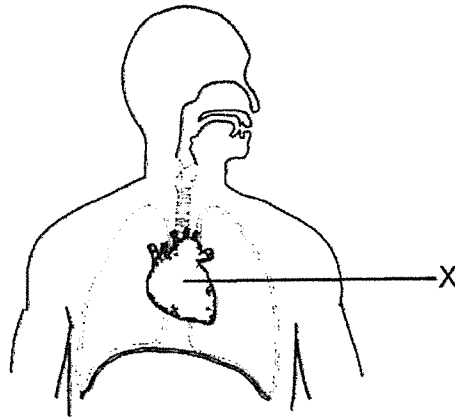

Organ X pumps blood around the body. Which system does organ X belong to?

- (1) digestive system
- (2) muscular system
- (3) circulatory system
- (4) respiratory system

5 Which one of the following statements about the function of the blood vessels is correct?

- (1) The blood vessels pump blood around the body.
- (2) The blood vessels transport blood throughout the body.
- (3) The blood vessels transport food and water throughout the plant.
- (4) The blood vessels allow oxygen to flow from the nose to the lungs.

6 The diagram below shows the flow of blood in certain parts of the body at rest.

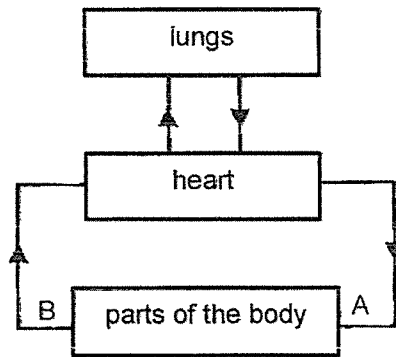

Which one of the following shows the correct comparison of oxygen and carbon dioxide in the blood at A and B?

	Blood at A	Blood at B
(1)	low in oxygen	low in carbon dioxide
(2)	low in oxygen	high in carbon dioxide
(3)	high in oxygen	low in carbon dioxide
(4)	high in oxygen	high in carbon dioxide

7 The diagram below shows parts of a fish, labelled S, T and U.

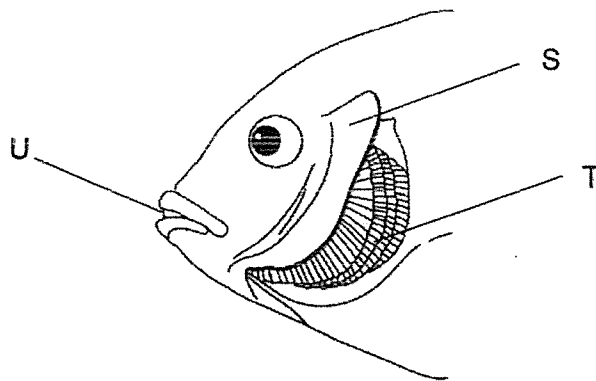

Based on the diagram above, which of the following statement(s) is/are correct?

- A Carbon dioxide is exchanged for oxygen at T.
- B S absorbs dissolved oxygen from the water for the fish to breathe.
- C Water containing dissolved oxygen enters the fish through U and leaves through T.

- (1) A only
- (2) A and C only
- (3) B and C only
- (4) A, B and C

- 8 The diagram below shows the lungs of a man. The arrows show the directions of air flow in and out of the lungs respectively.

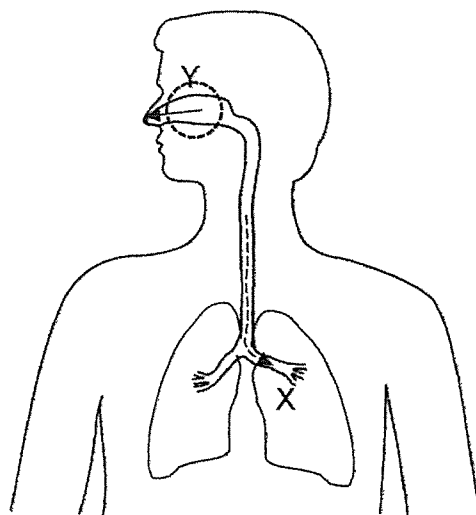

Which of the following shows correctly the amount of oxygen in the air that enters X when the man breathes in and the air that he breathes out at Y?

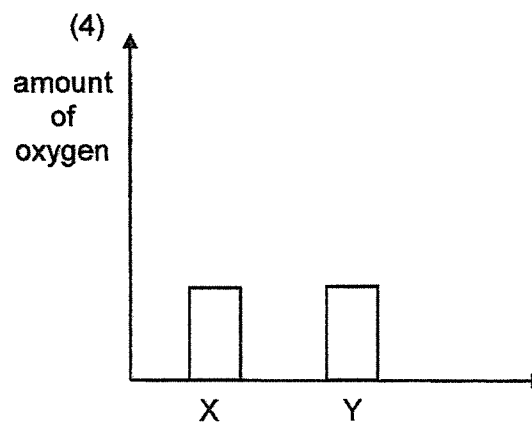
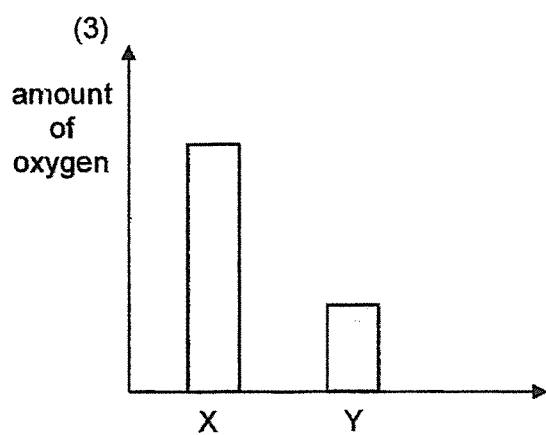
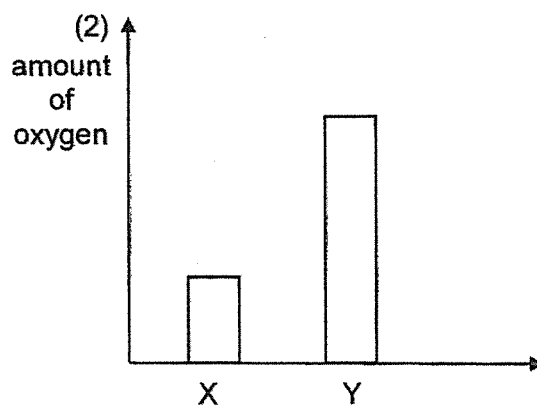
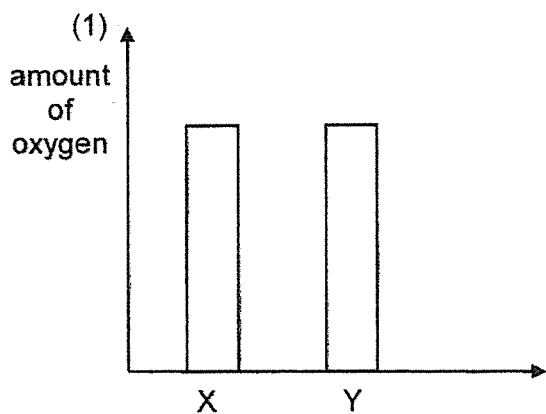

- 9 The diagram below shows how sand is separated from water using a filter paper. The filter paper only allows water to pass through it but not the sand.

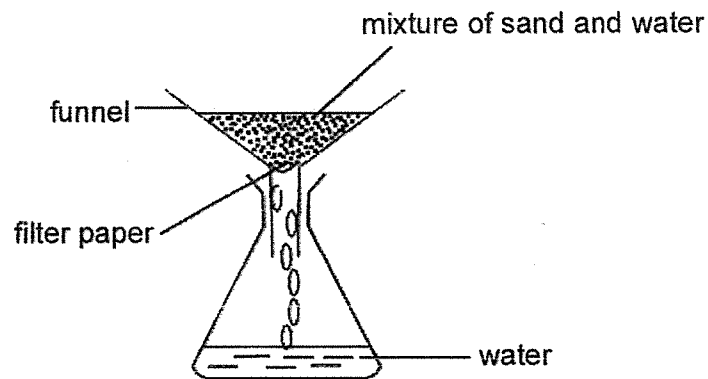

Which part of a cell has a similar function as the filter paper?

- (1) nucleus
  - (2) cell wall
  - (3) cytoplasm
  - (4) cell membrane
- 10 The diagrams below show two different types of cells, A and B.

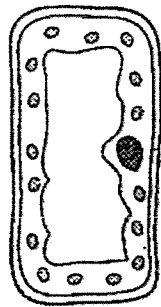

cell A

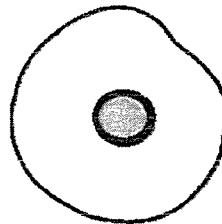

cell B

Based on your observations of the cells shown above, which of the following cell parts are found in cell A but not in cell B?

- A the nucleus
  - B the cell wall
  - C the chloroplasts
  - D the cell membrane
- (1) A and B only
  - (2) A and D only
  - (3) B and C only
  - (4) C and D only

11 Which of the statements about life cycles of animals are true?

- A The young and the adult look similar for all animals.
- B All life cycles of all animals involve growth and reproduction.
- C Different types of animals have different number of stages in their life cycles.
- D The young of some animals go through a different number of stages of life cycles from their parents.

- (1) A and B only
- (2) A and C only
- (3) B and C only
- (4) C and D only

12 Which of the following graphs below shows the correct relationship between the mass of the seed leaves and the height of the plant as the young plant grows during germination?

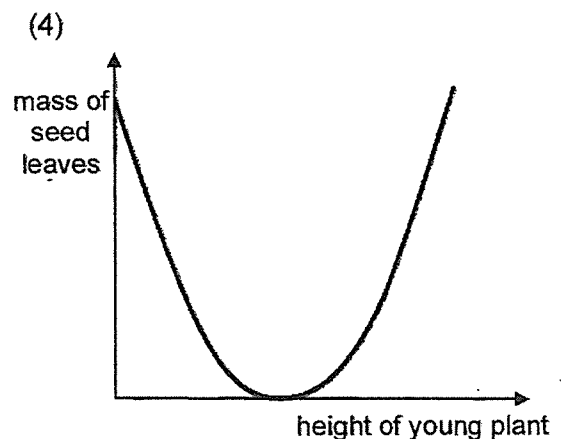
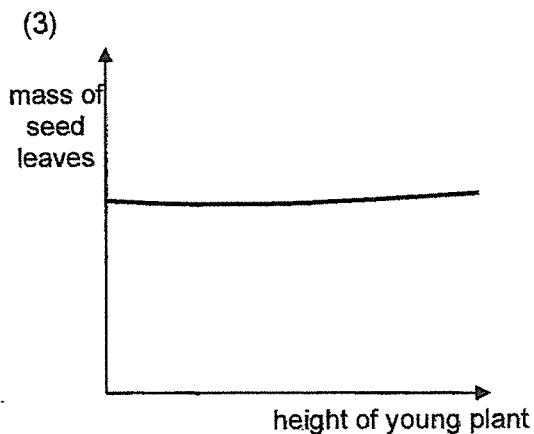
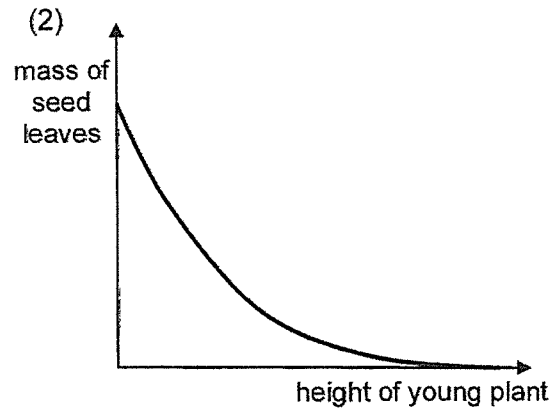
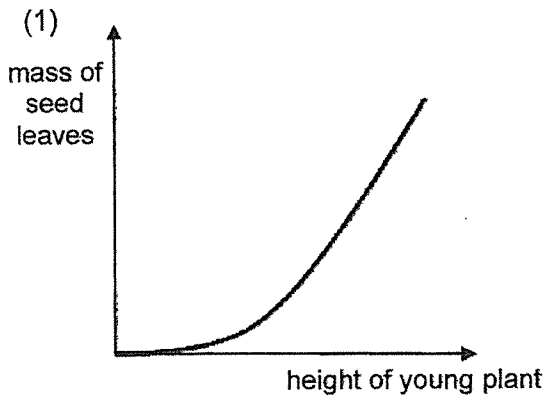



13 The diagrams below show the reproductive systems of a human and a plant.

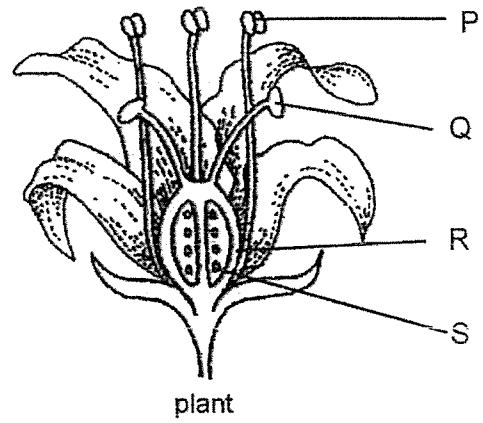
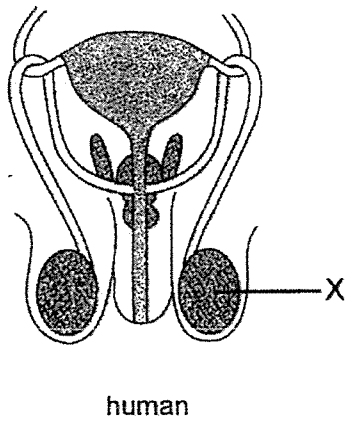

Which part, P, Q, R or S, in the reproductive system of the plant has a similar function as part X in the reproductive system of the human?

- (1) P
- (2) Q
- (3) R
- (4) S

- 14 The diagram below shows two similar plants, A and B, of the same kind but they produce different coloured flowers.

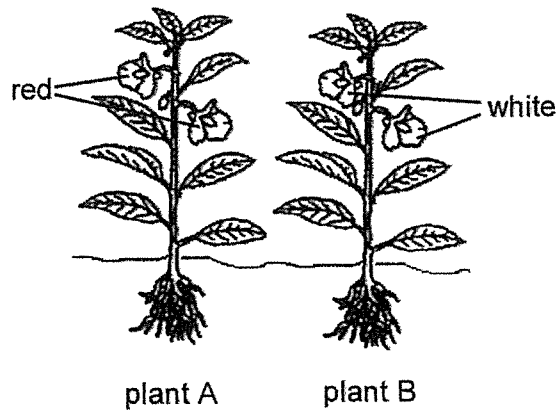

A farmer planted the seeds from plant A but not the seeds from plant B. Why do these seeds grow into new plants that produce only red flowers?

- A Seeds from plant A have characteristics of the red flower.
- B Seeds from plant A only have characteristics of the white flower.
- C The new plants will inherit the characteristics of the red flower from the parent plant.

- (1) B only
- (2) C only
- (3) A and B only
- (4) A and C only

- 15 The diagram below shows the fruit of a flowering plant.

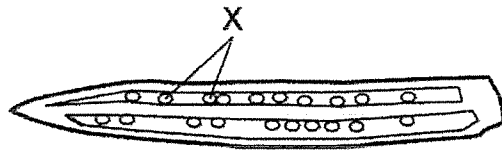

Which of the following statements about X are true?

- A X helps in the fertilisation process.
- B X are the pollen grains of the flower.
- C X are formed from the ovules of the flower.
- D X can be germinated to grow into new plants.

- (1) A and B only
- (2) B and C only
- (3) C and D only
- (4) A, C and D only

- 16 The diagram below shows a flower of plant Y. The reproductive parts are hidden in the flower.

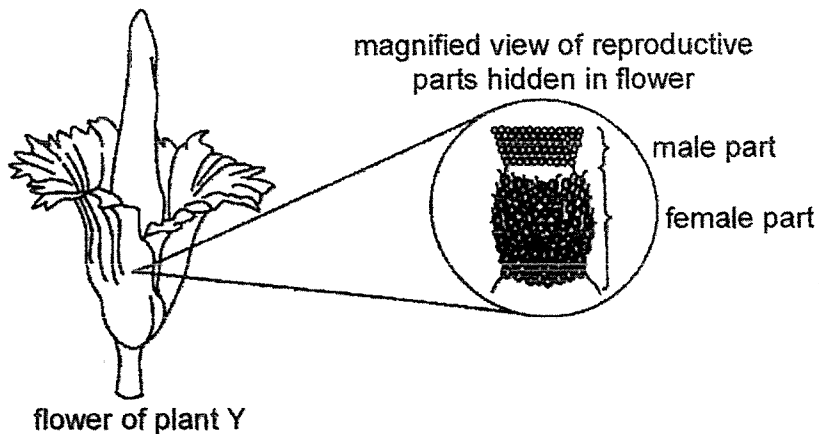

The flower gives off a strong scent. It was observed that the female part of the flower opens first for two days and then dies, before the male part opens and dies. How is plant Y pollinated?

	Method of pollination	Number of flowers involved in the pollination
(1)	wind	one
(2)	wind	two
(3)	insect	one
(4)	insect	two

- 17 The diagram below shows a way to separate a mixture of materials. The mixture is poured onto a moving belt Z.

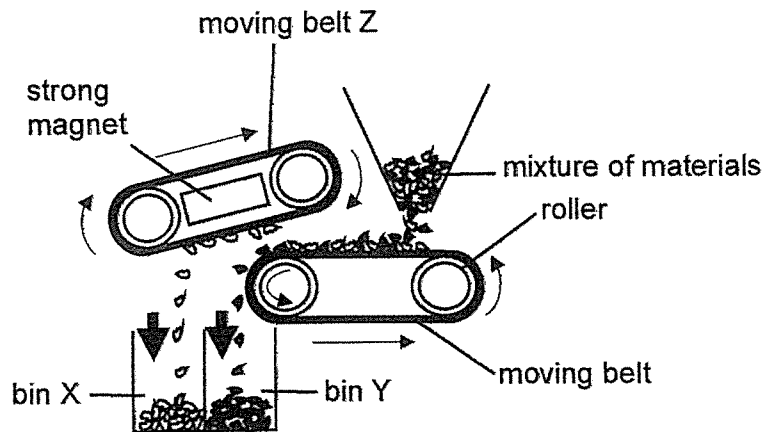

What could be the material collected in bins X and Y?

	Bin X	Bin Y
(1)	iron	steel
(2)	steel	wood
(3)	wood	glass
(4)	glass	plastic



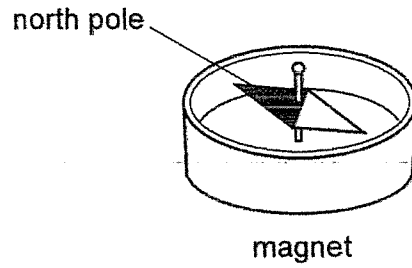

- 18 The diagram below shows a compass. The compass has a small magnet that can rotate freely.

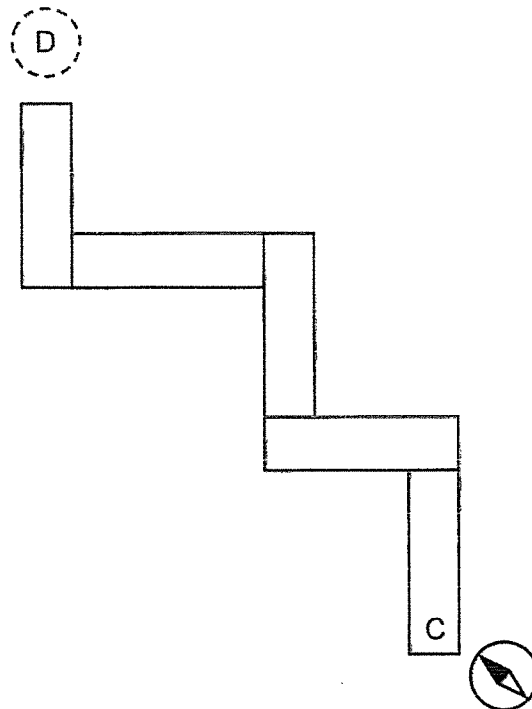

Alan arranged four bar magnets such that they were attracted to one another. A compass was placed near end C and the direction of the compass needle is shown below.



Which one of the following showed the direction of the needle when the compass was placed at D?

- (1)  (2)  (3)  (4) 

- 19 Sean conducted an experiment as shown below. He filled up a displacement can with water and slowly lowered a stone in. The water that flowed out from the displacement can was collected in a measuring cylinder.

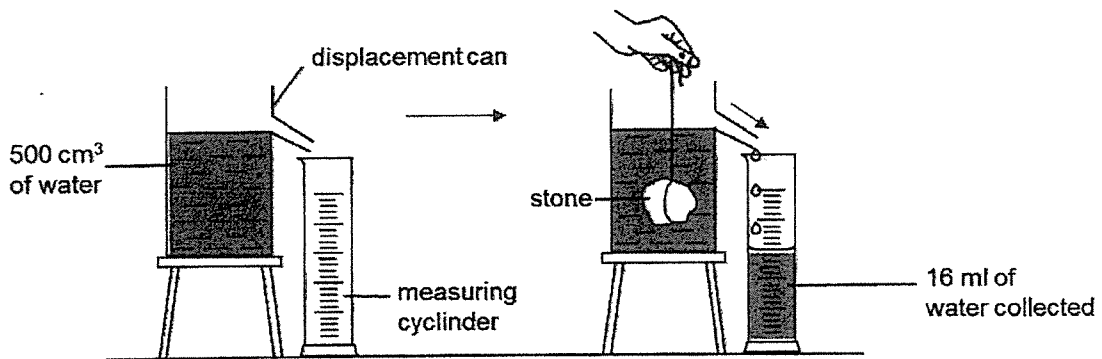

What could Sean conclude from this experiment?

- (1) The mass of the stone was 16 g.
  - (2) The stone compressed the water in the displacement can.
  - (3) The volume of the water left in the displacement can was still  $500 \text{ cm}^3$ .
  - (4) The volume of the water in the measuring cylinder was the volume of the stone.
- 20 The diagram below shows a water tank used for flushing a toilet bowl. Lesser volume of water was required to fill the water tank when a rock was placed in it.

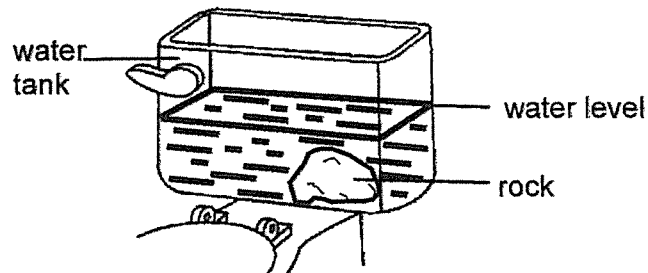

Based on the diagram above, which of the following statements are correct?

- A The rock compresses the water in the water tank.
  - B The water level will decrease when the rock is removed.
  - C The volume of the rock stays the same when it is taken out of the water.
- (1) A and B only
  - (2) A and C only
  - (3) B and C only
  - (4) A, B and C

- 21 Deon placed three solids of the same size but made of materials S, T and U into a container of water. The diagram below shows his observation.

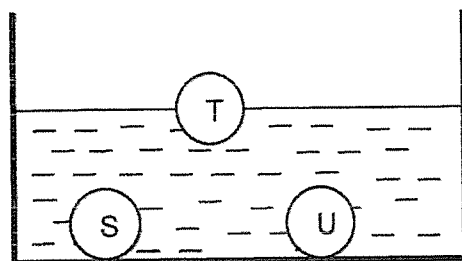

He made two statements:

- A "S and U are the same material."  
B "T and U are different material."

Which statement(s) can be concluded from his observation?

- (1) A only  
(2) B only  
(3) A and B  
(4) None of the above
- 22 Mrs Tan set up the following experiment in a dark room. The light sensor on screen gave a reading of 60 units.

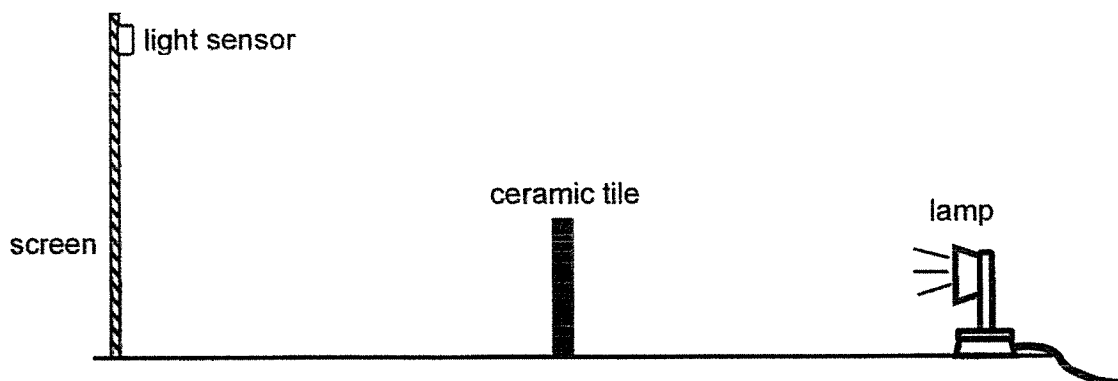

As Mrs Tan moved one object in the set-up, the reading on the light sensor increased slowly to 70 units and then dropped to 0 unit suddenly.

Which object did Mrs Tan move and in which direction?

- (1) lamp towards ceramic tile  
(2) ceramic tile towards screen  
(3) lamp away from ceramic tile  
(4) screen away from ceramic tile

23 The properties of materials P, Q, R and S are shown below.

Properties	Material P	Material Q	Material R	Material S
strength	×	✓	✓	✓
flexibility	✓	×	✓	✓
waterproof	✓	✓	×	✓
transparency	✓	✓	✓	×

Which material, P, Q, R or S, is most suitable to be use to make part W? Part W of the car needs to withstand strong wind and heavy rain.

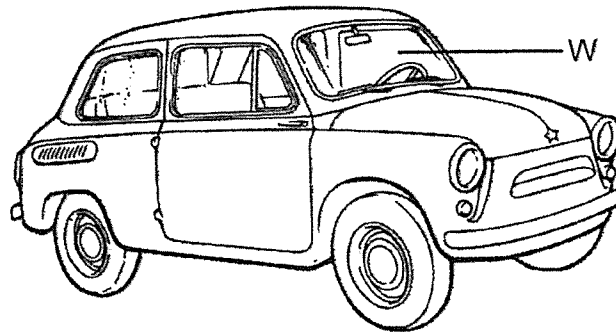

- (1) Material P
- (2) Material Q
- (3) Material R
- (4) Material S



24 Susie stuck her spoon into her bowl of ice cream as shown in the diagram below.



After a while, when she touched the spoon with her fingers, she found that it felt cold. Which of the following statements correctly explained her observation?

- (1) Heat travelled from her fingers to the spoon.
- (2) Heat travelled from the ice cream to the spoon.
- (3) Coldness travelled from the spoon to her finger.
- (4) Coldness travelled from the ice cream to the spoon.

25 Mr Muthu poured boiling water into a glass as shown in the diagram below.

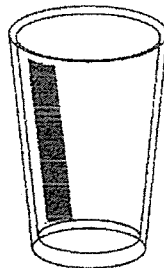

The glass cracked as he was pouring it. What could be the cause of the crack?

- (1) There was uneven expansion of the glass.
- (2) The boiling water expanded more than the glass.
- (3) The glass could not hold the mass of the boiling water.
- (4) The glass conducted the heat from the water too quickly.

26 A group of pupils set up the circuit below.

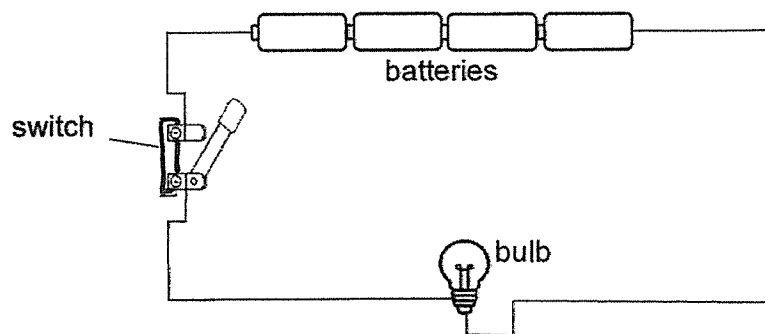

When the switch was closed, the bulb lighted up for a while, then it became unlit. Which of the following could be the possible reason for this observation?

- (1) The switch was closed too quickly.
- (2) The bulb was not connected correctly.
- (3) Too many batteries were used in the circuit.
- (4) The batteries were arranged in the wrong direction.

27 Study the set-up below.

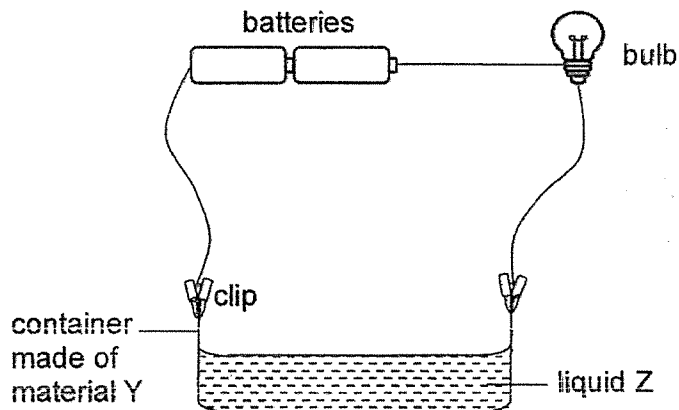

When the clips were connected to the container, the bulb lit. Which of the following is/are the possible reason(s) for the bulb to light up?

	<b>Container made of material Y</b>	<b>Liquid Z</b>
A	insulator of electricity	electrical conductor
B	insulator of electricity	electrical insulator
C	conductor of electricity	electrical conductor
D	conductor of electricity	electrical insulator

- (1) A only
- (2) A and B only
- (3) B and D only
- (4) C and D only

28 Study the circuit shown below.

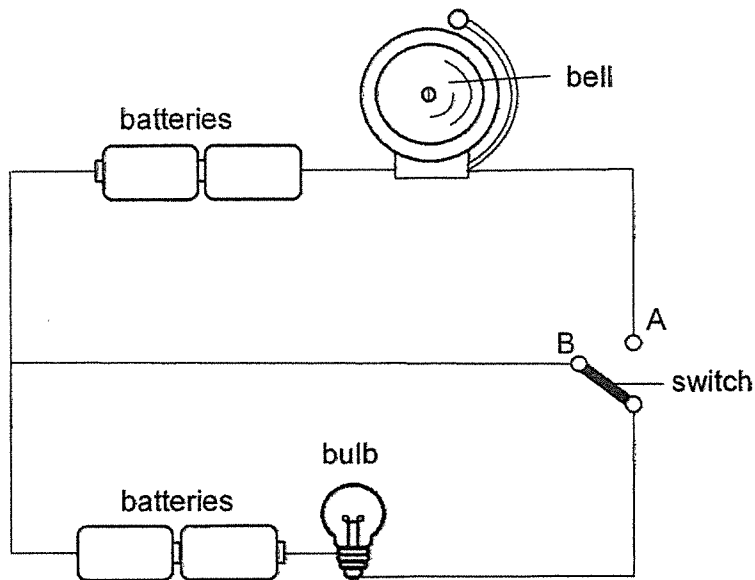

Siti observes that the bulb lights up when the switch closes at point B.  
 What happens to the bell and the bulb when the switch closes at point A instead?

	Bell	Bulb
(1)	rings	lights up
(2)	rings	does not light up
(3)	does not ring	lights up
(4)	does not ring	does not light up



**NAN HUA PRIMARY SCHOOL  
END-OF-YEAR EXAMINATION 2021  
PRIMARY 5**

**SCIENCE**

**BOOKLET B**

**13 Open-ended questions (44 marks)**

**Total Time for Booklets A and B: 1 hour 45 minutes**

**INSTRUCTIONS TO CANDIDATES**

1. Write your name and index number in the space provided.
2. Do not turn over the page until you are told to do so.
3. Follow all instructions carefully.
4. Answer all questions.
5. Write your answers in this booklet.

**Marks Obtained**

<b>Section B</b>		<b>/ 44</b>
------------------	--	-------------

**Name:** \_\_\_\_\_ ( )

**Class: P 5 S** \_\_\_\_\_

**Date: 27 October 2021**

**Parent's Signature:** \_\_\_\_\_

---

This booklet consists of 19 pages.

**Section B: (44 marks)**

Write your answers to question 29 to 40.

The number of marks available is shown in brackets [ ] at the end of each question or part question.

- 29 The diagram below shows how substances are transported in different parts of the plant. The arrows represent the movement of food and substances P and Q.

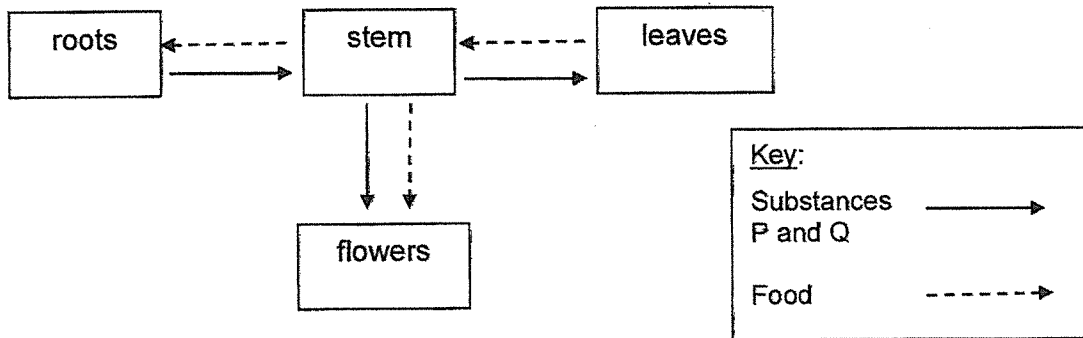

Identify substances P and Q that are taken in by the plant. Describe how the substances are taken in and transported to the flowers. [2]

---

---

---

Score	2
-------	---

30 The diagram below shows how Siti's heart rate changed over a period of time.

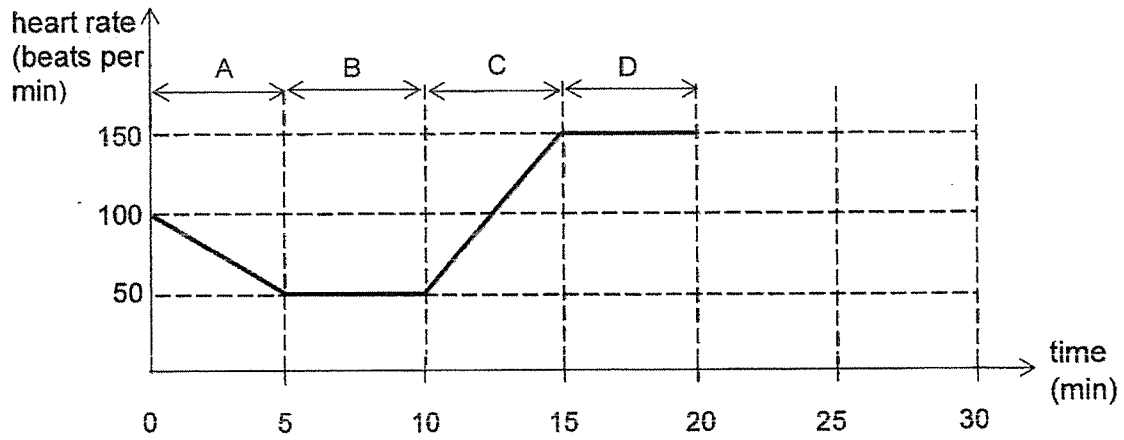

- (a) Siti started jogging at the 10<sup>th</sup> minute. State the change in her heart rate from the 10<sup>th</sup> to 15<sup>th</sup> minute. Explain your answer. [2]

---

---

---

---

- (b) Based on the graph above, during which period, A, B, C or D, was the amount of oxygen taken in by Siti the greatest? [1]

---

Score	3
-------	---

31 The following diagram shows plant A with two of its parts labelled.

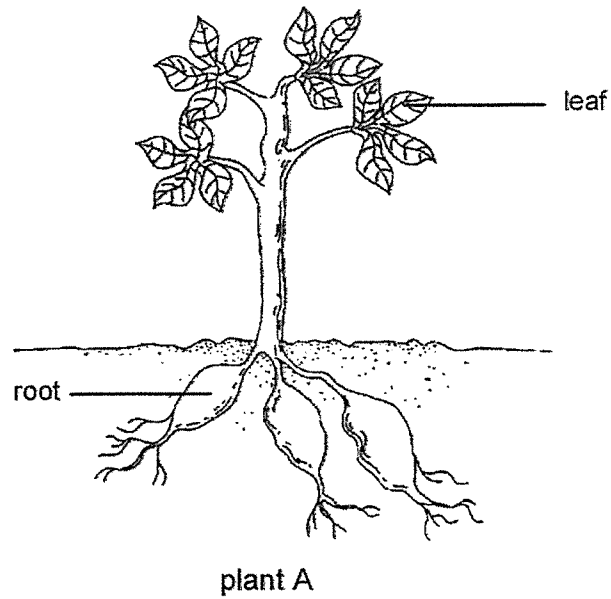

The following cells, R and S, are taken from these two parts of plant A.

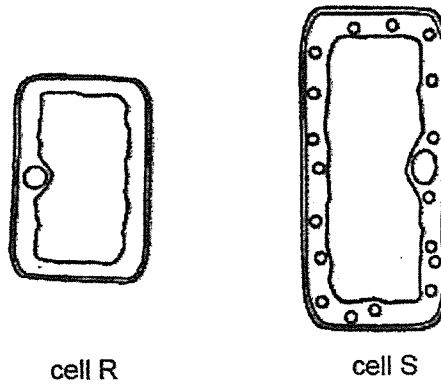

(a) James said that cell R is taken from the root of plant A, while cell S is taken from its leaf. Do you agree with James? Explain why. [1]

---

---



- (b) James then conducted an experiment using two similar plants. He removed an outer ring from the stem of one of the plants, as shown below. The food-carrying tubes were removed while the water-carrying tubes remained in the stem.

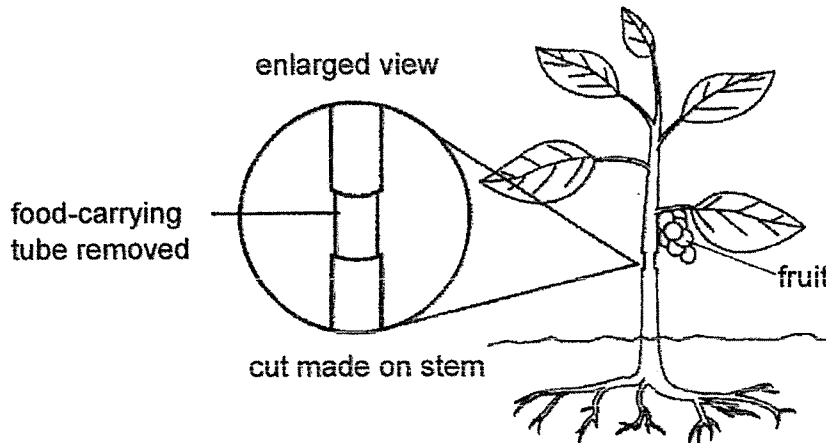

After some time, the two plants produced fruits as shown below.

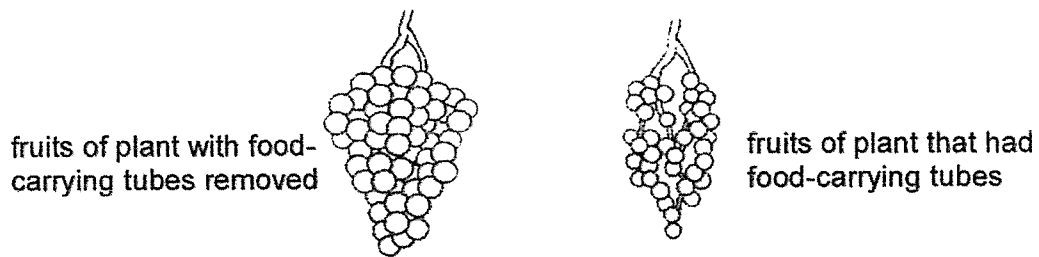

- (i) Explain how removing the food-carrying tubes helped to produce bigger fruits. [2]

---



---



---

- (ii) After another three weeks, James observed that the plant with the cut made on the stem died. Explain why removing the food-carrying tubes cause the plant to die. [1]

---



---

Score	4
-------	---

- 32 Mandy wanted to find out how the surface area of the wing affects the time taken for a fruit to reach the ground.

She dropped three identical fruits with different wing surface areas from a fixed height and measured the time taken for them to reach the ground.

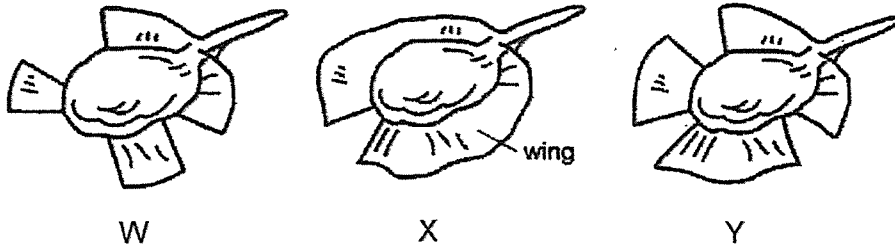

The table below shows her results.

Fruits	W	X	Y
Time taken for fruit to reach the ground (s)	1.6	5.4	3.3

- (a) State the changed variable in Mandy's experiment. [1]

---

- (b) State the relationship between the surface area of the wing of the fruit and the time taken for the fruit to reach the ground. [1]

---

---

- (c) The young plants grow far apart from their parent to prevent overcrowding. Explain why growing far apart from one another benefit the plants. [1]

---

---

Score	3
-------	---

- 33 Lisa set up the following experiment as shown in the diagram below. She puts an equal number of seeds in two identical test tubes. Each test tube had an equal amount of cotton wool.

The cotton wool in set-up A was damp while the one in set-up B was dry as shown in the diagram below.

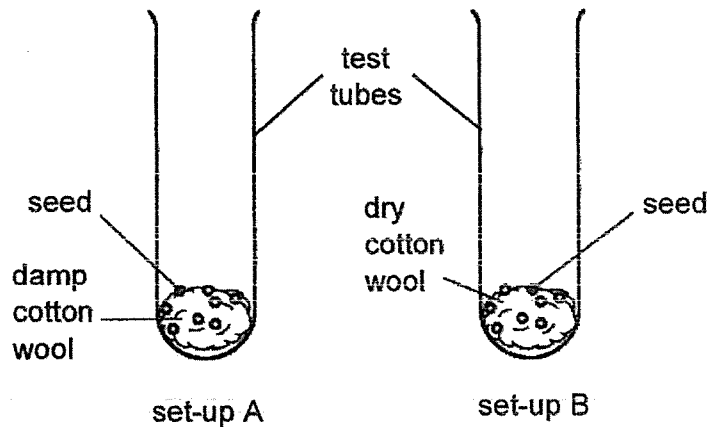

Lisa placed both set-ups in a dark cupboard.

After two weeks, she noticed that in set-up A, the seeds germinated into young seedlings but none of the seeds in set-up B had germinated.

- (a) Explain Lisa's observations of the seeds in both set-ups after two weeks. [2]

Set-up A: \_\_\_\_\_  
\_\_\_\_\_

Set-up B: \_\_\_\_\_  
\_\_\_\_\_

- (b) State two changes to set-up B if Lisa wants to find out whether light is needed for germination. [1]

\_\_\_\_\_  
\_\_\_\_\_

Score	3
-------	---

34 The diagram below shows one flower of plant X.

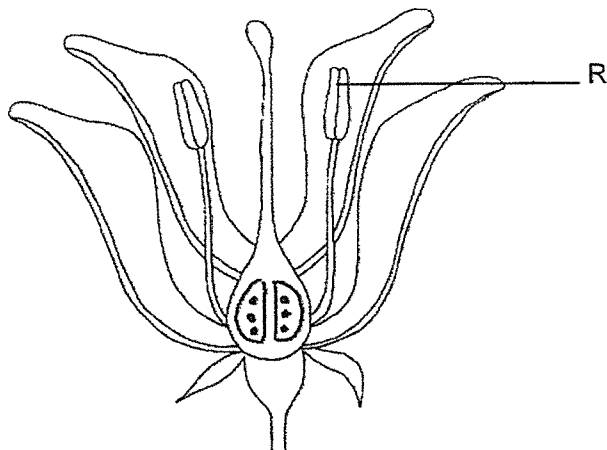

(a) Roger removed part R from a flower of plant X. After some time, he observed that the flower could form a fruit. Explain why. [2]

---

---

---

---

Roger found that plants X, Y and Z can each be pollinated by only one type of butterfly, A, B or C, as shown in the table below.

Plants	Butterfly responsible for pollination
X	A
Y	B
Z	C

Roger counted the number of butterflies A, B and C found near plants X, Y and Z over a period of time and plotted a graph as shown below.

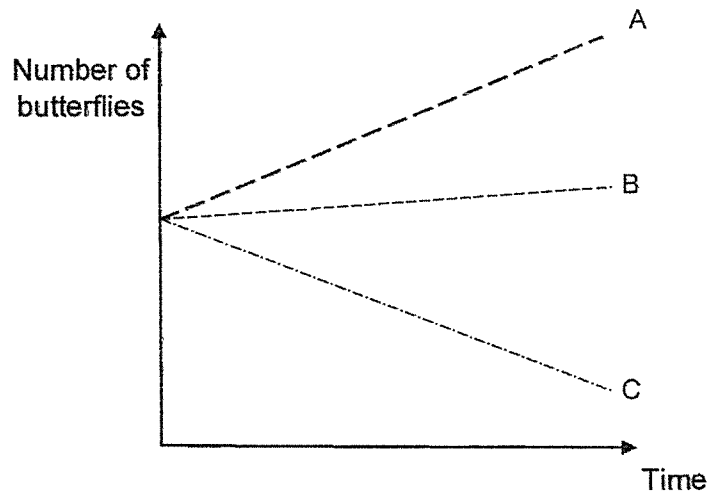

(b) Based on the graph above, which plant, X, Y or Z, would there be a decrease in the number of fruits formed? Explain why. [2]

---



---



---

Score	4
-------	---

35 Malek set up a circuit shown below.

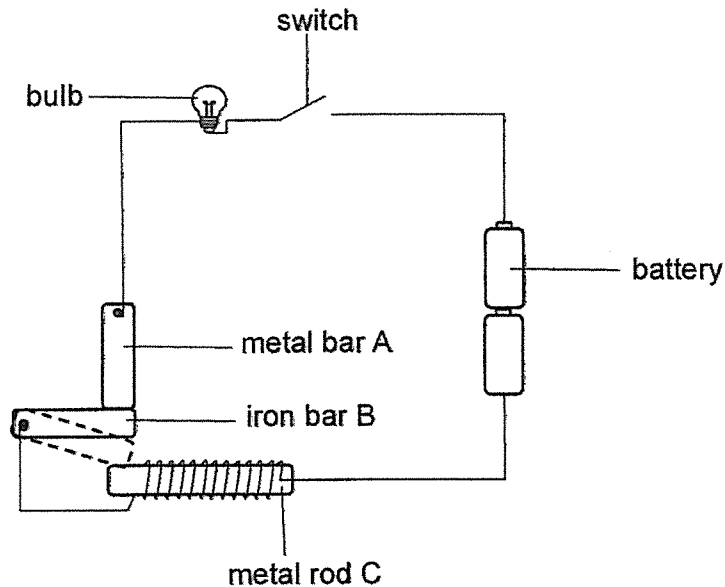

When he closed the switch, the bulb lit up. He then observed that iron bar B moved away from metal bar A, touched metal rod C and the bulb became unlit.

(a) Explain why iron bar B moved away from metal bar A to touch metal rod C. [2]

---



---



---

(b) Without changing the distance between iron bar B and metal rod C, state two ways Malek could do to shorten the time taken for iron bar B to move and touch metal rod C. [2]

(i) \_\_\_\_\_

(ii) \_\_\_\_\_

(c) Malek replaced metal rod C with metal rod D. When the switch was closed, the bulb lit up but iron bar B did not move towards metal rod D. Based on his observation, state one property of the metal used to make rod D. [1]

---

Score	5
-------	---

36 Meiling set up an experiment as shown.

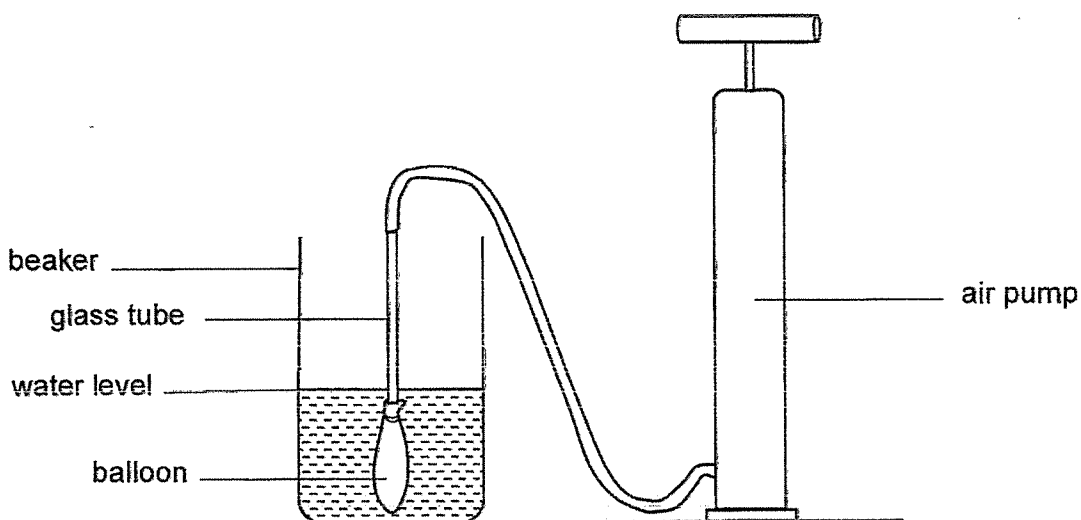

(a) When Meiling pumped air into the balloon, the balloon started to inflate. What would happen to the water level? [1]

---

(b) What property of matter does this experiment show? [1]

---

Meiling conducted another experiment using the set-up below. The container had a capacity of  $200 \text{ cm}^3$ . It contained  $100 \text{ cm}^3$  of water and  $100 \text{ cm}^3$  of air at the start of the experiment.

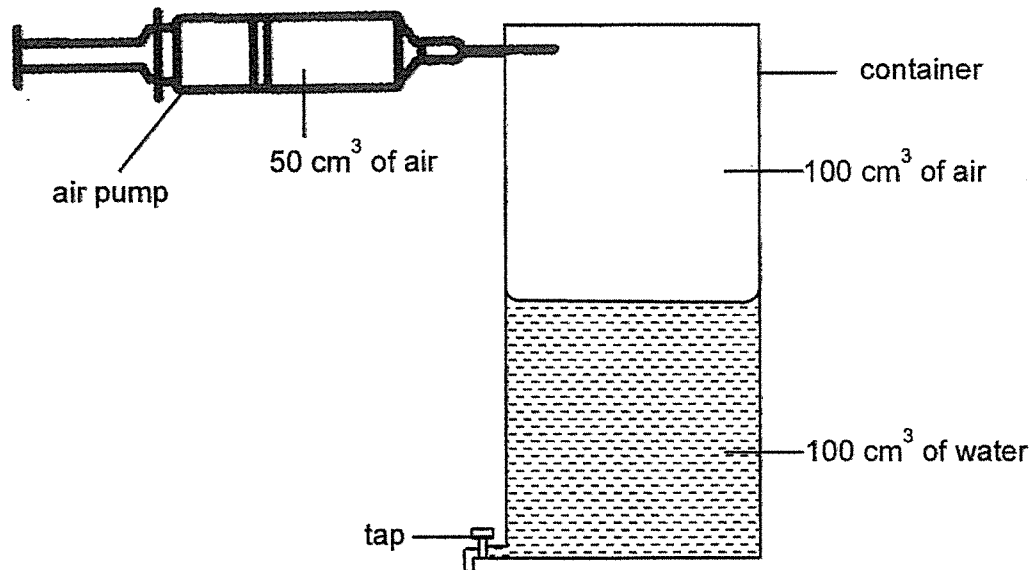

- (c) She pumped  $50 \text{ cm}^3$  of air into the container and drained off all the water in the tank. What will be the final volume of air in the container? [1]

---

- (d) Using the properties of matter, explain your answer in part (c). [1]

---

---

Score	4
-------	---



37 In a factory, metal pipes are used to transport steam from one place to another.

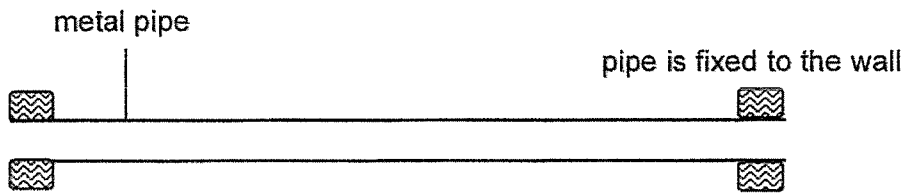

When a long and straight pipe is used, the pipe will break as shown in the diagram below.

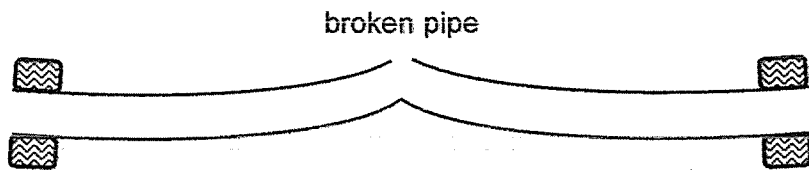

Explain why the straight pipe breaks when steam is transported in it. [2]

---

---

---

Score	2
-------	---

38 The experiment below was set up in a dark room.

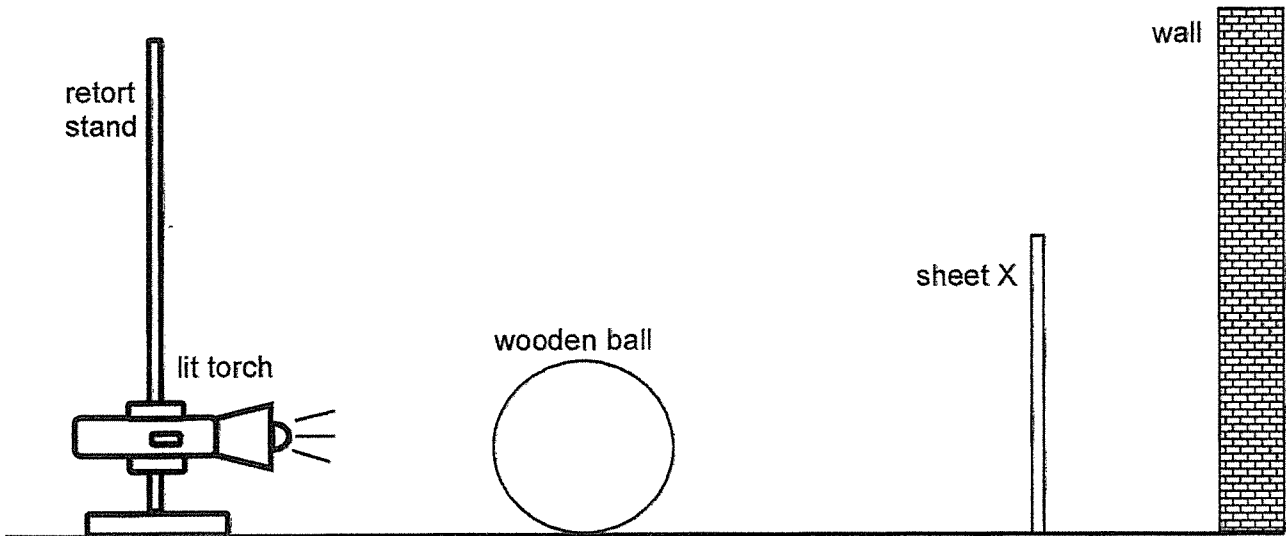

When the torch was turned on, the shadow of the wooden ball was clearly formed on sheet X only.

- (a) Put a tick (✓) in the boxes below to show the properties of the wooden ball and sheet X. [2]

	Allow no light to pass through	Allow some light to pass through	Allow most light to pass through
Wooden ball			
Sheet X			

- (b) Without moving the torch, what can you do to make the shadow of the wooden ball appear smaller on sheet X? [1]

---

Score	3
-------	---

39 Ken filled 4 bottles, P, Q, R and S, each made of a different material, with cold water at 5 °C. The bottles were of identical shape and size. He recorded the temperature of the water in each bottle over 5-minute intervals for 35 minutes using the datalogger as shown in the diagram below.

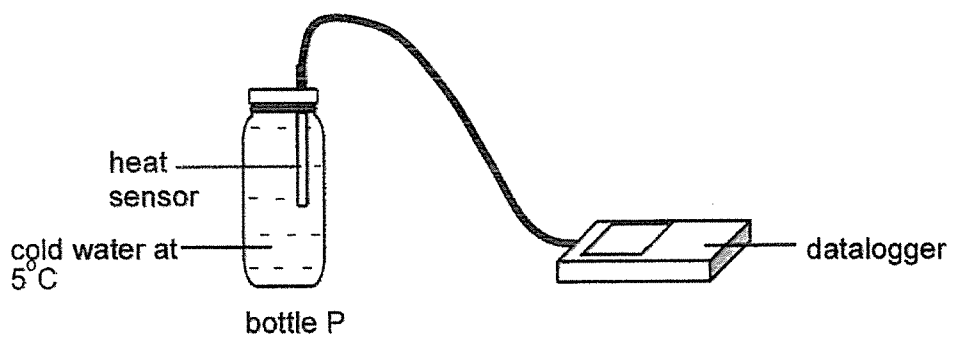

He plotted the results as shown in the graph below.

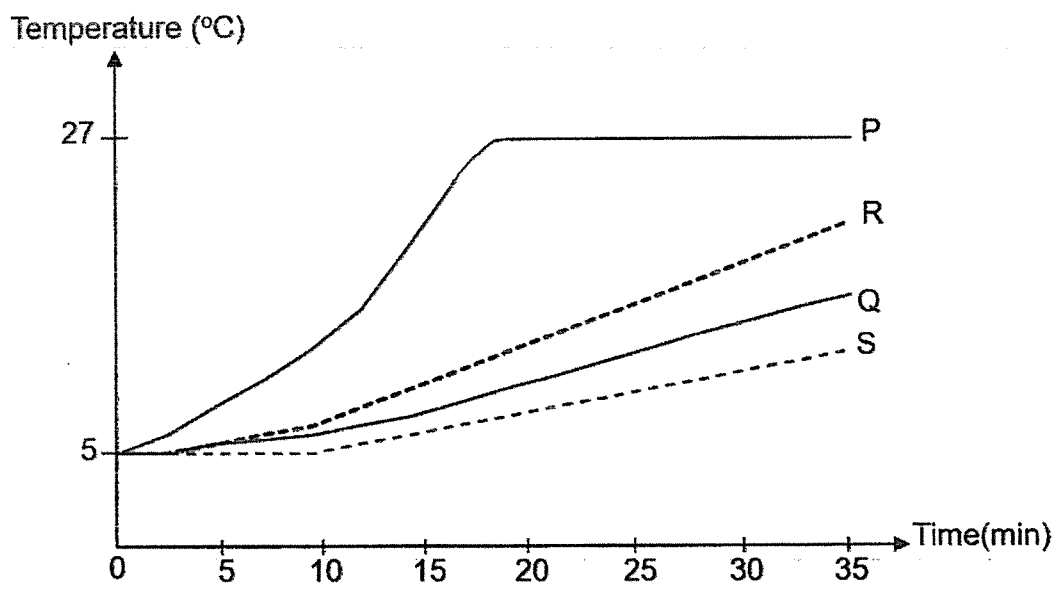

(a) What is temperature? [1]

---



---

(b) State the measured variable in this experiment. [1]

---

- (c) Based on the graph, arrange the bottles, P, Q, R and S, starting from the bottle made from the material which is the best conductor of heat to the bottle made from material which is the poorest conductor of heat. [1]

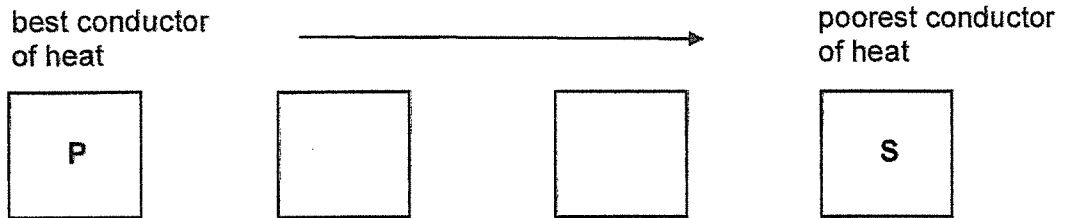

- (d) Based on the experiment, which bottle, P, Q, R or S, should Ken use to contain his hot tea so that it will be kept warm for the longest time? Explain your choice. [1]

---

---

---

- (e) Why did the temperature of water in bottle P stop increasing after the 20<sup>th</sup> minute? [1]

---

Score	5
-------	---

40 Leon set up a circuit as shown below. All five bulbs were lit when all four switches were closed.

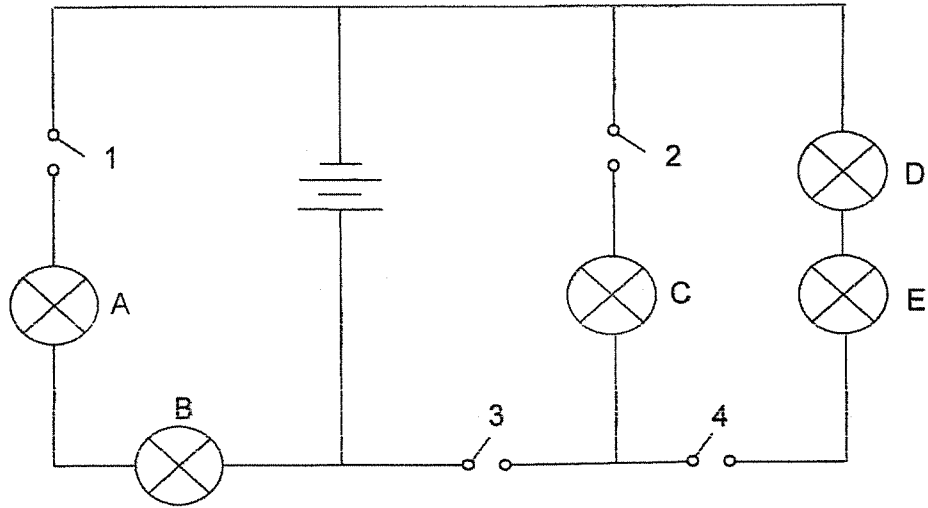

(a) What is the most number of bulbs to be lit by closing only one switch? [1]

---

(b) Leon connected a wooden block to the circuit as shown below.

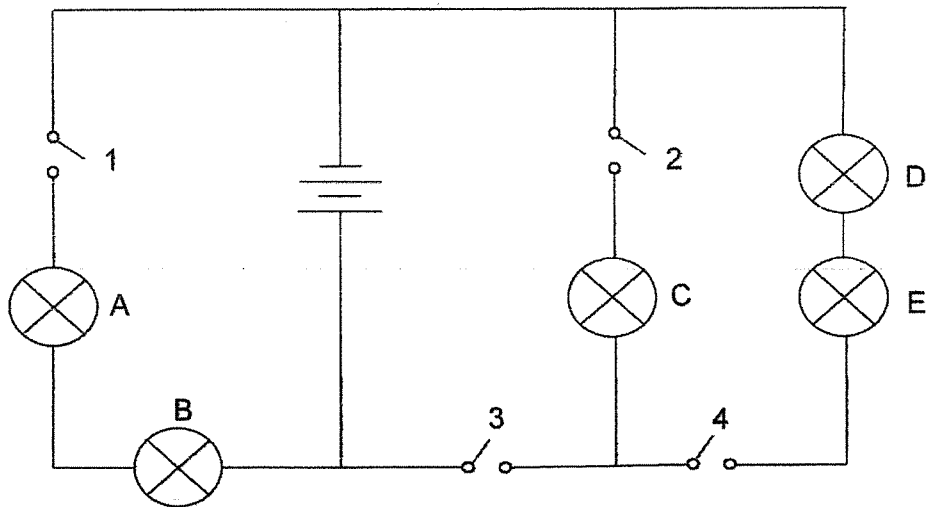

All the light bulbs did not light up when all the switches are closed. Mark the position of the wooden block on the circuit above with an 'X'. [1]

Score	2
-------	---

41 George prepared a circuit tester as shown in the diagram below.

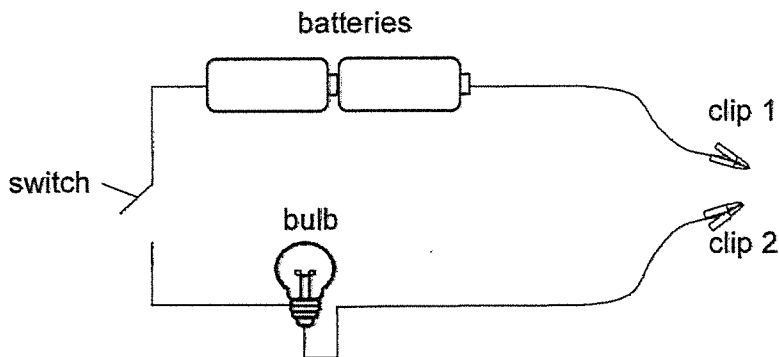

He clipped the two ends of the circuit tester at various paper clips, A, B, C, D and E, of the circuit board below. The wires of the circuit board are hidden behind the board.

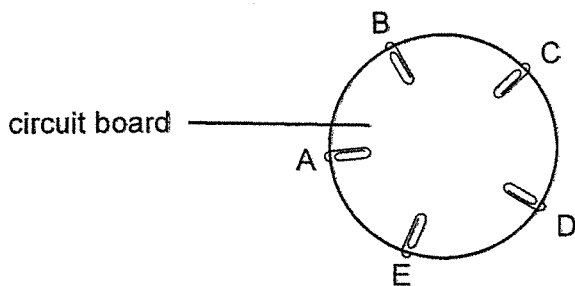

The table below shows the results collected from his experiment.

Clip 1	Clip 2	Bulb
A	B	unlit
A	C	lit
B	C	unlit
C	D	lit
D	E	unlit

(a) Using only 2 wires for each of the circuit board below, show two different ways of getting the results shown in the table above. [2]

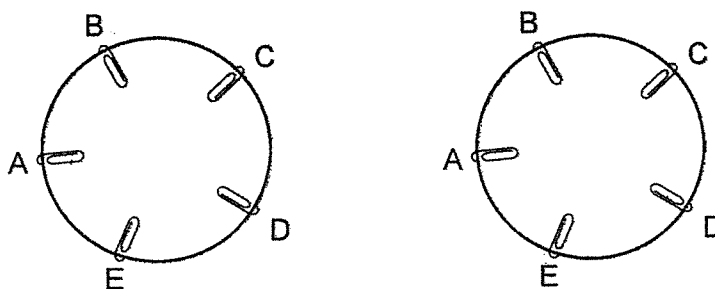

(b) George set up a circuit shown below.

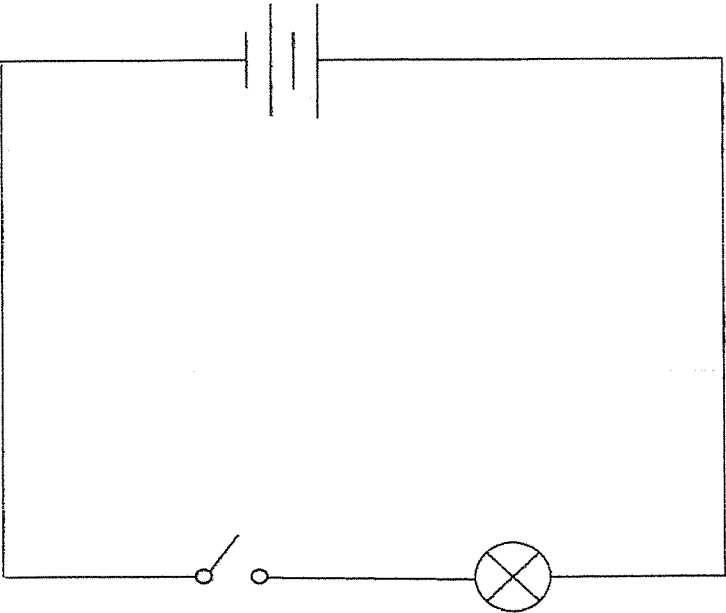

Using symbols, draw another light bulb, a switch and some wires on the circuit diagram above such that the two light bulbs could be separately switched on or off. [2]

Score	4
-------	---

End of paper

**Nan Hua Primary School**  
**END OF YEAR EXAMINATION 2021**  
**Primary 5 Science**  
**ANSWER KEY**

**Section A : ( 24 x 2= 54 marks)**

Question	Answer	Question	Answer	Question	Answer
1	2	11	3	21	2
2	2	12	2	22	1
3	3	13	1	23	2
4	3	14	4	24	1
5	2	15	3	25	1
6	4	16	4	26	3
7	2	17	2	27	4
8	3	18	1	28	1
9	4	19	4		
10	3	20	3		

**Section B : 44 marks**

Qn	Answer
29	Substances P and Q are <b>water and mineral salts</b> . Water and mineral salts enter the <b>roots</b> and move up the stem to the (leaves and) flowers <b>through the water-carrying tubes</b> .
30a	The heart rate increased to pump <b>blood containing oxygen and digested food/nutrients faster</b> to the body to release <b>more energy</b> .
30b	Period D
31a	Yes. R is taken from the roots as it does not contain chloroplasts.



31bi	Since food-carrying tubes were removed, food made by the leaves <b>could not be transported to the part of the plant below/down the cut stem</b> . Hence, <b>more food was stored</b> at the fruits so the plant with the outer ring removed had bigger fruits.
31bii	When the food-carrying tubes are removed, <b>the roots will not be able to receive food and dies</b> . The roots will then be unable to absorb water and mineral salts or the plant, thus causing the plant to die.
32a	the surface area of the wing of the fruit
32b	The <b>greater</b> (smaller) the surface area of the wing of the fruit, the <b>longer</b> (shorter) the time taken for the fruit to reach the ground.
32c	Growing far apart from one another would help to reduce competition from one another for water, nutrients/mineral/mineral salts, space and sunlight.
33a	Set-up A: The seeds have <b>water, warmth and oxygen</b> so they can germinate. Set-up B: Although there is warmth and oxygen, <b>water was absent</b> in set-up B for seeds to germinate.
33b	Put set-up B near the window/ near a light source. <b>AND</b> Add (equal) amount of water to the cotton wool in set-up B.
34a	<b>Pollen grains</b> from <b>another flower of the same kind</b> were dropped onto the stigma of the flower. After the flower was pollinated, <b>fertilisation</b> occurred and a fruit was developed.
34b	Plant Z. Based on the graph, only the number of butterfly C <b>decreased</b> over time, so there were <b>fewer</b> butterflies to pollinate flowers of plant Z. Hence, there would be fewer fruits formed.
35a	When the <b>circuit was closed/electric current flowed through the coil of wire around metal rod C</b> , it became an <b>electromagnet</b> , thus <b>attracting</b> iron bar B.
35b	Increase the number of coils of wire around metal rod C Increase the number of batteries
35c	It is not a magnetic material.

36 a	The water level would rise/ increase.														
36 b	Matter occupies/ takes up space.														
36 c	200 cm <sup>3</sup>														
36d	Air has <b>no definite volume</b> and <b>it takes the volume/space of the container.</b>														
37	When steam passes through the metal pipe, the metal pipe <b>gained heat from the steam</b> and <b>expands</b> . However, as there pipe is fixed to the wall, there is <b>no room for expansion</b> , so the pipe breaks.														
38a	<table border="1"> <thead> <tr> <th></th> <th>Allow no light to pass through</th> <th>Allow some light to pass through</th> <th>Allow most light to pass through</th> </tr> </thead> <tbody> <tr> <td>Ball</td> <td>✓</td> <td></td> <td></td> </tr> <tr> <td>Sheet X</td> <td>✓</td> <td></td> <td></td> </tr> </tbody> </table>				Allow no light to pass through	Allow some light to pass through	Allow most light to pass through	Ball	✓			Sheet X	✓		
	Allow no light to pass through	Allow some light to pass through	Allow most light to pass through												
Ball	✓														
Sheet X	✓														
38b	Move the ball nearer/closer to the sheet X. OR Move the ball further away from the light source. OR Move sheet X nearer to the ball.														
39a	Temperature is a <b>measure/degree</b> of hotness(of a body)														
39b	Temperature of the water (in the bottle)														
39c	P, R, Q, S														
39d	Bottle S. The decrease in the temperature of the water in the bottle is the least. Hence it is <b>poorest conductor of heat</b> , so tea in the bottle will <b>lose heat slowest to the surrounding</b> , keeping the tea warm for the longest time.														

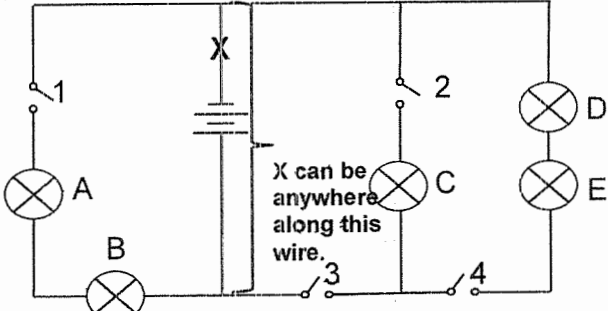
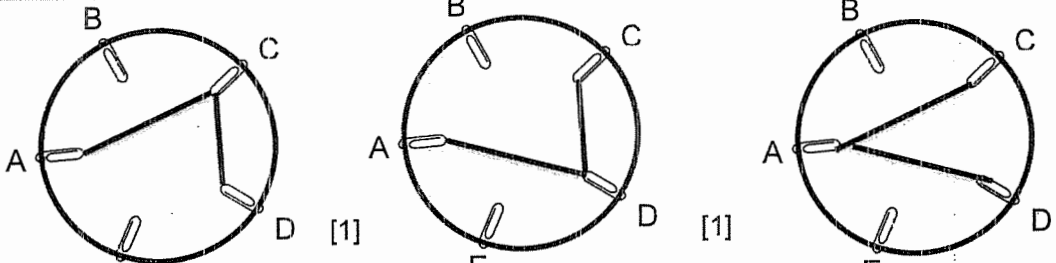
39e	The temperature of water in the bottle had reached room temperature.
40a	Two
40b	
41a	
41b	