

**Red Swastika School
Primary 5 Science 2021
Revision Paper 1**

Name: _____ () Date: 4 Oct 2021

Class : P5 _____

For Questions 1 to 28, choose the most suitable answer and shade its number in the OAS provided.

1. Study the two organisms, A and B below.

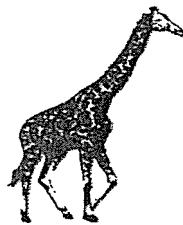

Organism A



Organism B









Which set of information correctly describes organisms A and B?

	Organism A		Organism B	
	Covered with scales	Have fins	Covered with scales	Have fins
(1)	No	Yes	Yes	No
(2)	No	No	No	Yes
(3)	Yes	No	No	Yes
(4)	No	No	Yes	Yes

3. The table below shows the characteristics of two organisms, A and B. A tick (✓) indicates that the characteristic is observed and a cross (✗) indicates that it is not observed.

Characteristics	Organism A	Organism B
able to make food	✗	✓
has spores	✓	✓
has flowers	✗	✗

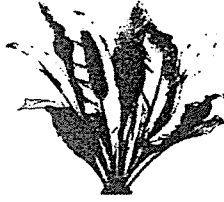
Based on the table above, which of the following organisms correctly represent A and B?

	Organism A	Organism B
(1)	 sunflower	 mushroom
(2)	 mushroom	 bird's nest fern
(3)	 bread mould	 sunflower
(4)	 bird's nest fern	 bread mould

4. Which of the following comparison(s) is/are false?

	Plant Transport System	Human Circulatory System
A	Has tubes that transport substances	Does not have tubes to transport substances
B	Transports food produced by the leaves only	Transports digested food only
C	There is no organ to pump the substances through the system	The heart pumps blood through the system

- (1) A only
- (2) A and B only
- (3) B and C only
- (4) A and C only

5. The diagram below shows how food and various gases are transported in the human body.

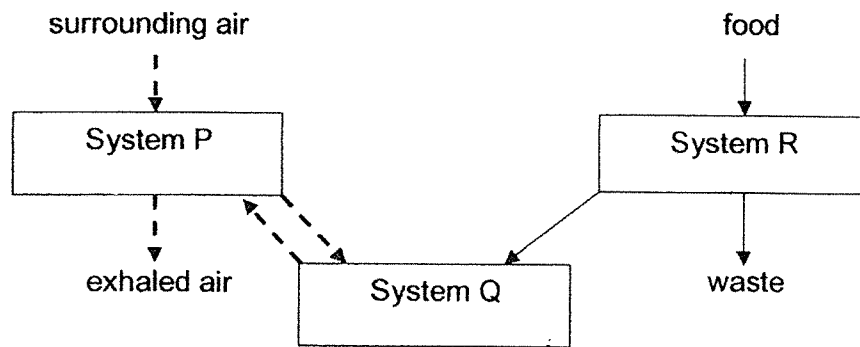

Which of the following best identifies P, Q and R?

	System P	System Q	System R
(1)	respiratory	circulatory	digestive
(2)	respiratory	digestive	circulatory
(3)	circulatory	digestive	respiratory
(4)	digestive	respiratory	circulatory

6. A group of children were trapped in a lift. After one hour, they felt very uncomfortable as the types of gases in the air in the lift changed.

Which of the following shows correctly the change in the amount of the types of gases in the air after being trapped in the lift for one hour?

(1)

Types of gases in the air	Change in the amount of gases after one hour
oxygen	decreased
carbon dioxide	decreased
water vapour	stayed the same

(2)

Types of gases in the air	Change in the amount of gases after one hour
oxygen	increased
carbon dioxide	increased
water vapour	increased

(3)

Types of gases in the air	Change in the amount of gases after one hour
oxygen	increased
carbon dioxide	decreased
water vapour	decreased

(4)

Types of gases in the air	Change in the amount of gases after one hour
oxygen	decreased
carbon dioxide	increased
water vapour	increased

7. The diagrams below show three cells, X, Y and Z.

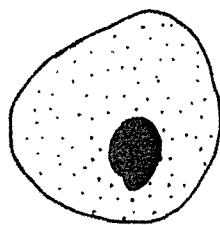

Cell X

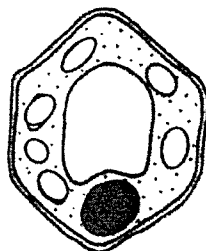

Cell Y

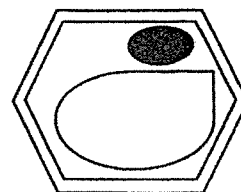

Cell Z

Which of the following statements is true about cells X, Y and Z?

- (1) They are animal cells.
- (2) They can make food.
- (3) They have cytoplasm and a cell wall.
- (4) They have a nucleus and a cell membrane.

8. The diagram below shows the human digestive system.

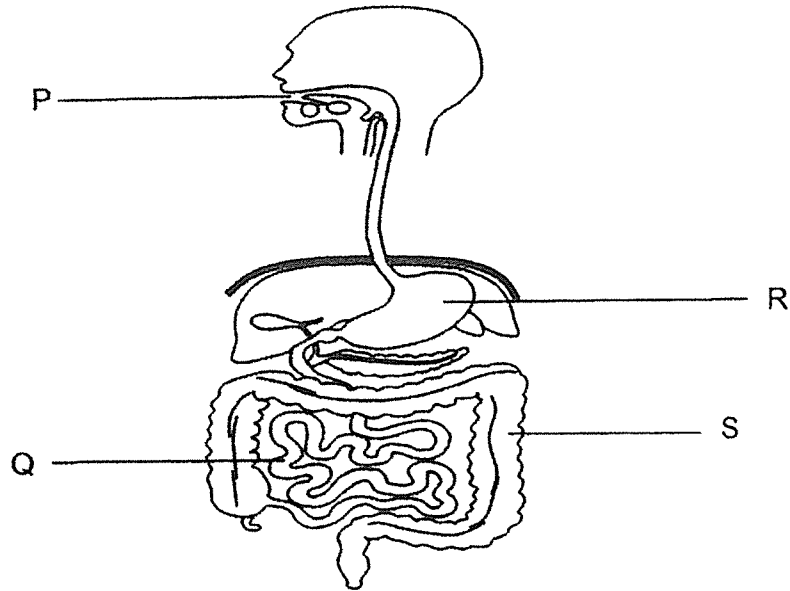

Three students each made a statement about the parts of the digestive system.

Ranesh: Digestion is completed here.

Lin Min: Digestive juices are added here.

Vivian: Water is absorbed from the undigested food here.

Which of the part(s) P, Q, R and S, match correctly to the statements made by the three students?

	Ranesh	Lin Min	Vivian
(1)	Q	P, Q	R
(2)	Q	P, R, Q	S
(3)	S	P, R, Q	S
(4)	S	R, Q	P

9. Study the flower shown.

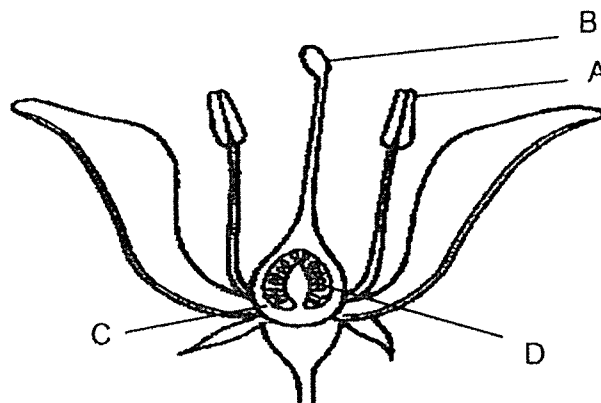

Part(s) of the flower is/are removed. After some time, the flower developed into a fruit. Which part(s) was/were removed?

- (1) A only
- (2) B only
- (3) A and B only
- (4) C and D only

10. For an adult plant to produce seeds, which process(es) must take place?

- (1) germination
- (2) fertilisation
- (3) pollination and fertilisation
- (4) germination and pollination

11. A student made three statements about sexual reproduction in plants and humans.

- A Fertilisation occurs in a female reproductive part.
- B Reproductive cells are produced in the testes.
- C The fertilised egg is found in the ovary.

Which of the following shows the statements correctly matched to plants and humans?

	Plants	Humans
(1)	A, C	B
(2)	B, C	A, C
(3)	A, C	A, B
(4)	A	A, B, C

12. Study the dispersal of seeds by plants P, Q and R.

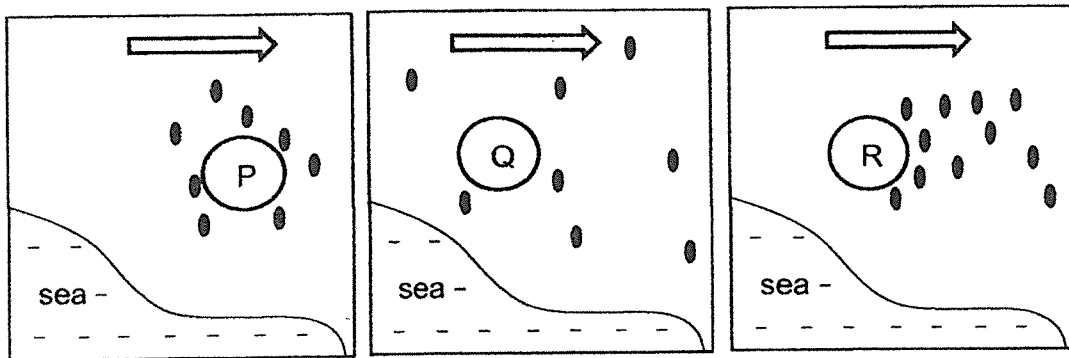
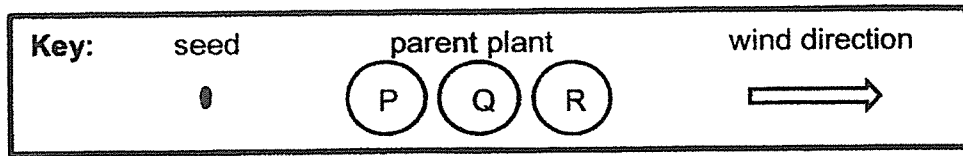

Which of the following correctly represents the seed dispersal method for plants P, Q and R respectively?

	Plant P	Plant Q	Plant R
(1)	animal	splitting	wind
(2)	splitting	animal	wind
(3)	animal	wind	splitting
(4)	wind	animal	splitting

13. Jia En set up three arrangements of identical batteries, wires and bulbs as shown in the diagram below.

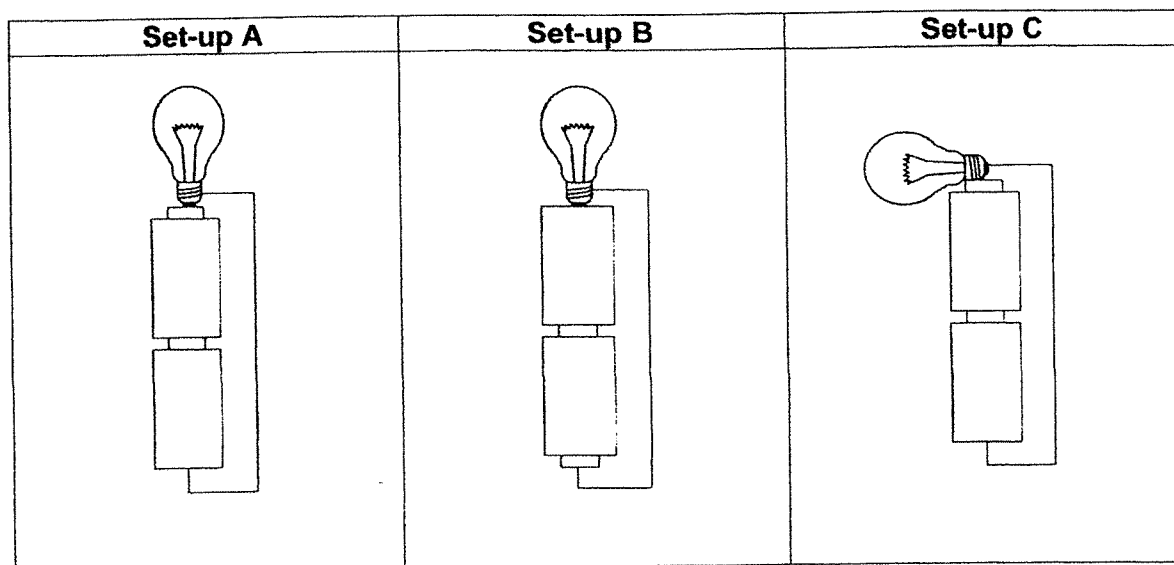

Which of the following statements is correct?

- (1) None of the bulbs will light up.
 - (2) Only the bulb in set-up A will light up.
 - (3) The bulb in set-up A will be brighter than the bulb in set-up B.
 - (4) The bulbs in all three set-ups have the same brightness.
14. Billy set up two circuits, A and B, as shown in the diagram. He wants to find out if the number of batteries in a circuit affects the brightness of the bulbs. However, his brother says that his experiment is not a fair one.

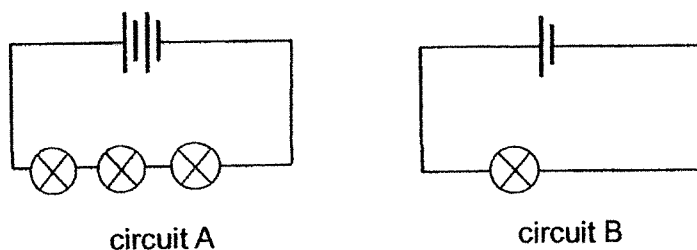

Which of the following must Billy do to achieve his aim?

- (1) Remove one battery from circuit A.
- (2) Remove one bulb from circuit A.
- (3) Add two bulbs in parallel arrangement to circuit B.
- (4) Add two bulbs in series arrangement to circuit B.

15. Siti connected three objects, X, Y and Z, to an electrical circuit as shown below. All the bulbs were in working condition.

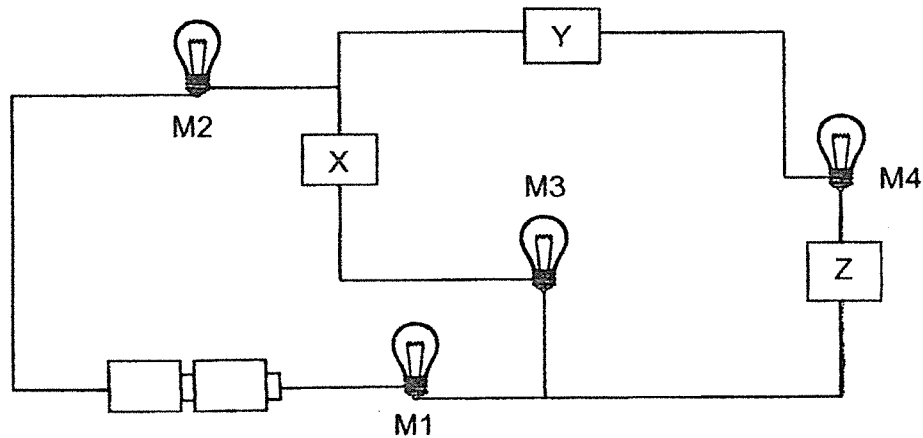

Which of the following is a possible observation?

	Electrical conductors	Bulb(s) that lit up
(1)	X and Z only	M1, M2 and M3 only
(2)	X, Y and Z	M1, M2 and M3 only
(3)	Y and Z only	M2 and M4 only
(4)	X, Y and Z	M3 and M4 only

16. Zhi Ming wanted to find out how the brightness of the bulb is affected by the length of wire A used in the circuit. He used the electric circuit shown in the diagram below to carry out his experiment.

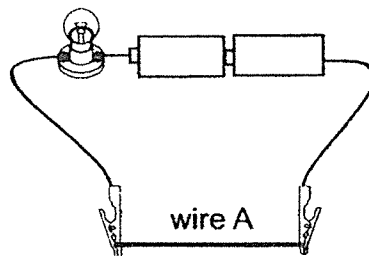

Which of the following variables should be kept constant to ensure a fair test?

- A: Length of wire A
- B: Number of batteries used
- C: Brightness of the bulb

- (1) A only
- (2) B only
- (3) B and C only
- (4) A and C only

17. The diagram below shows the changes in the states of water.

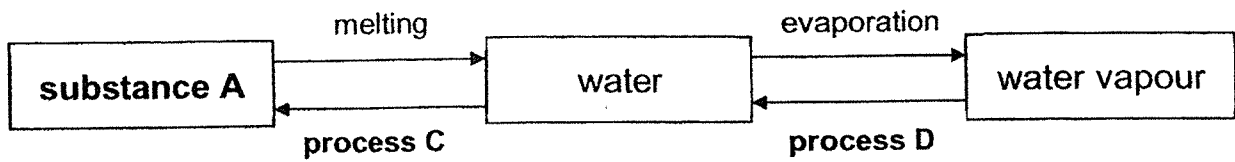

Which of the following correctly represents substance A and processes C and D?

	substance A	process C	process D
(1)	ice	evaporation	melting
(2)	ice	freezing	condensation
(3)	steam	boiling	condensation
(4)	steam	freezing	melting

18. Two syringes containing different substances are shown below.

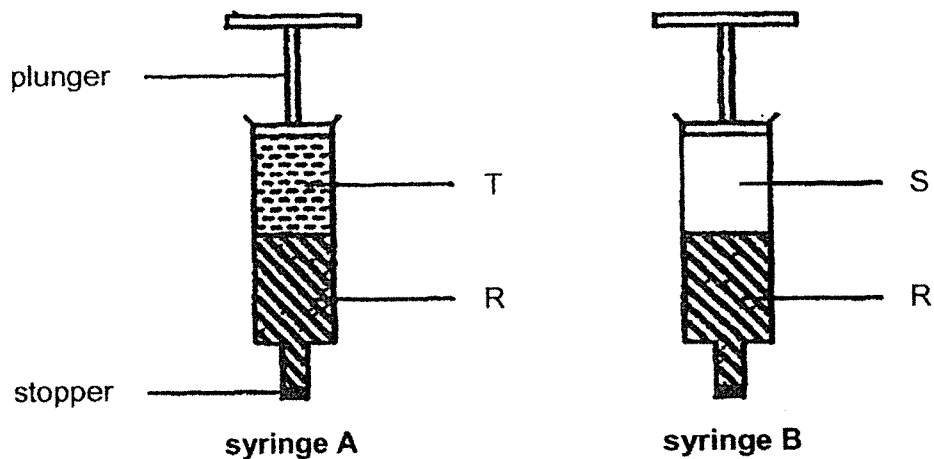

Which of the following best explains why only the plunger for syringe B could be pushed down but not the plunger for syringe A?

- (1) Substance S has no definite volume.
- (2) Substance S cannot be compressed.
- (3) Substance R has no definite volume.
- (4) Substance T can be compressed.

19. The diagram below shows the water cycle. X and Y represent two different processes.

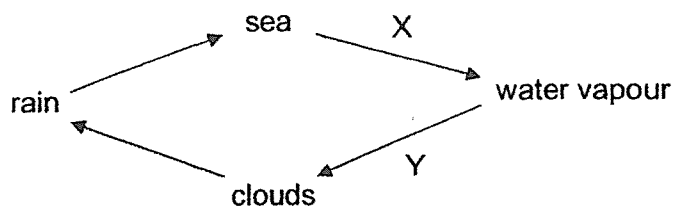

Which of the following statements is correct?

- (1) Water loses heat during process X.
 - (2) Water gains heat during process Y.
 - (3) Process X takes place at a fixed temperature.
 - (4) There is no change in state of matter when rain falls from the clouds.
20. The table below shows the freezing points and boiling points of 4 different substances W, X, Y and Z.

Substance	Freezing Point (°C)	Boiling Point (°C)
W	43	200
X	15	55
Y	90	100
Z	5	25

Which two of the substances are in the solid state at 30°C?

- (1) W and X
- (2) W and Y
- (3) X and Y
- (4) X and Z

21. The diagram below shows a steel bridge with one end of the bridge fixed while a gap is left at the other end supported by rollers.

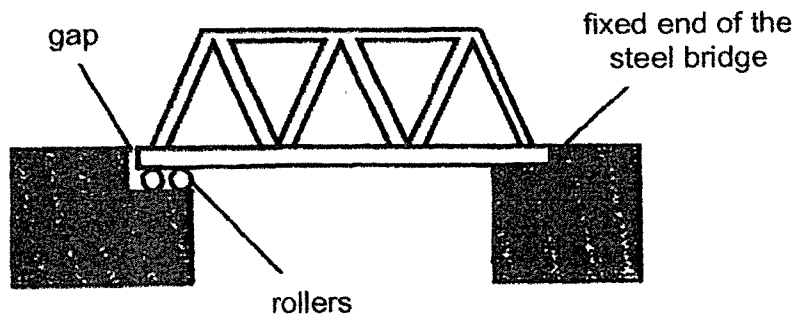

Why is there a gap at one end of the steel bridge?

- (1) To allow the steel bridge to decrease in volume due to expansion on a cold day.
- (2) To allow the bridge to increase in mass due to expansion on a hot day.
- (3) To allow the bridge to increase in volume due to expansion on a hot day.
- (4) To allow the bridge to decrease in mass due to contraction on a cold day.

22. A block of ice is placed in a closed box as shown in the diagram below.

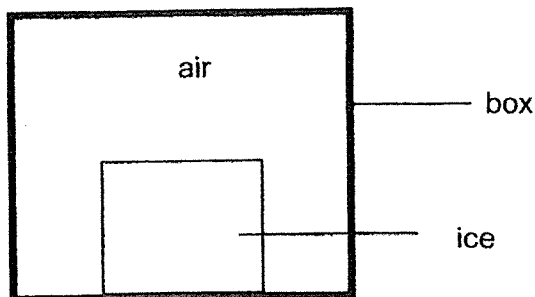

What will happen to the temperature of the ice and the air in the box during the process of melting?

	Temperature of ice	Temperature of air in the box
(1)	remains the same	decreases
(2)	increases	decreases
(3)	increases	remains the same
(4)	decreases	remains the same

23. The diagram below shows a container that can be used to keep ice cubes during a picnic. The ice cubes melt slowly when they are kept in the container.

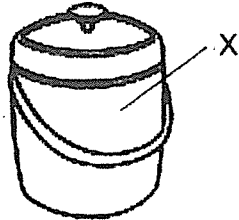

Study the properties of the four materials shown below.

Material	Property of material	
	Can bend easily	Can conduct heat easily
A	yes	yes
B	yes	no
C	no	no
D	no	yes

Which material is the most suitable for making part X of the container?

- (1) A
- (2) B
- (3) C
- (4) D

24. Hassan set up an experiment as shown below.

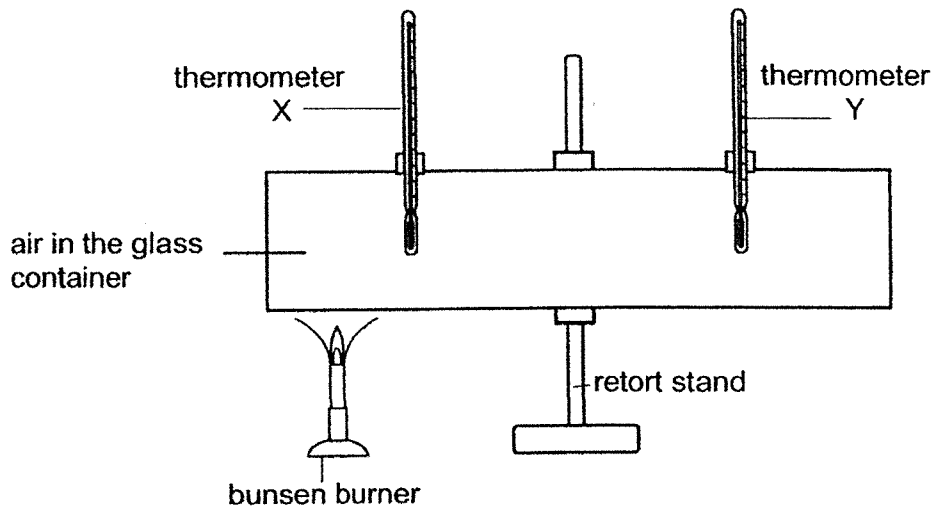

He recorded the temperature on the two thermometers at regular intervals in the table shown below.

Time (min)	Temperature on thermometers ($^{\circ}\text{C}$)	
	X	Y
0	28	28
2	30	29
4	33	31
6	38	34

Which of the following can he conclude based on the results of the experiment?

- A: Air is a conductor of heat.
- B: Air gains heat and expands.
- C: Heat travels from a hotter region to a colder region.

- (1) A only
- (2) B and C only
- (3) A and C only
- (4) A and B only

25. Jordan threw the ball upwards as shown in the diagram below.

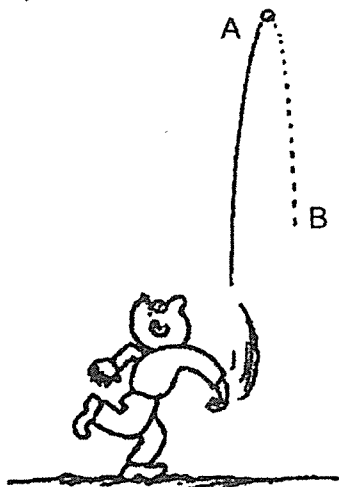

Which of the following is correct?

- (1) The gravitational force acting on the ball at point A is more than that at point B.
- (2) The gravitational force acting on the ball at points A and B are the same.
- (3) The ball has more gravitational force acting on it at a height higher than point A.
- (4) The ball has no gravitational force acting on it at point B.

26. Russell brought four magnets near each other and observed that they are attracted to each other as shown in the diagram.

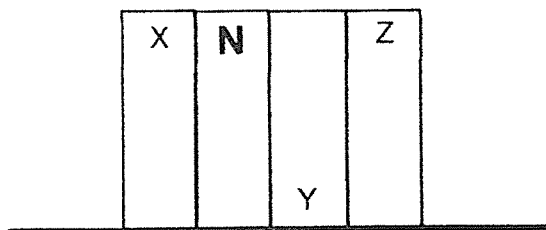

Which of the following correctly identifies poles X, Y and Z?

	X	Y	Z
(1)	South	North	North
(2)	South	North	South
(3)	North	South	North
(4)	North	North	South

27. Hannah hung different loads on two springs, X and Y. She observed and recorded the extension of each spring when different loads were hung on it.

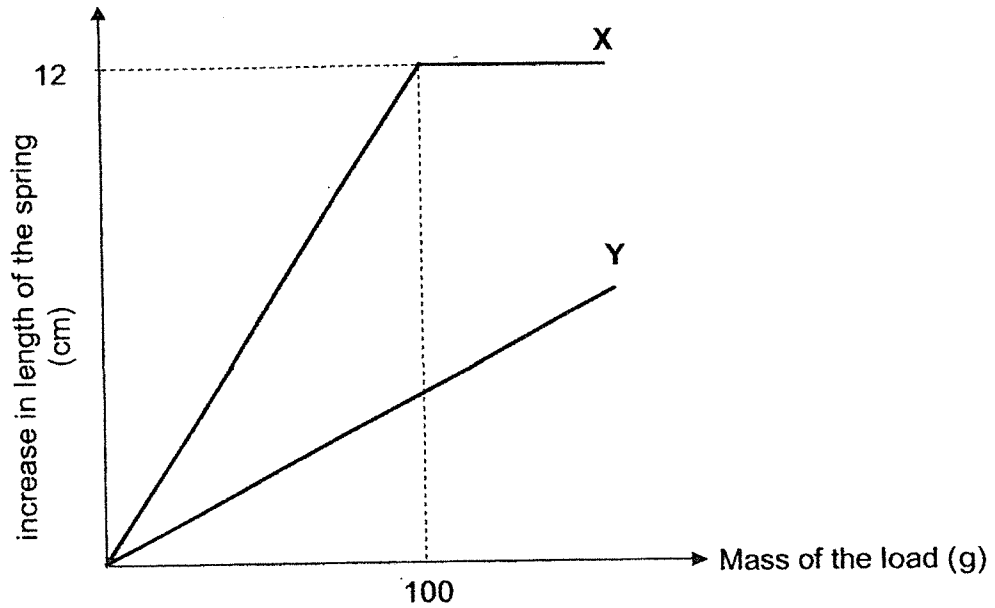

Based on the graph, which of the following is correct?

- (1) Spring Y is less stiff than spring X.
- (2) Spring X and Y have the same stiffness.
- (3) When a load of 100g was added, the length of spring X is 12 cm.
- (4) When a load of less than 100g was added, spring Y extends less than spring X.

28. Melissa set up the experiment as shown below. All magnets used are identical in shape and size. When magnet P was placed directly below magnet X, the wooden rod tilted as shown in diagram 2. She recorded the distance as indicated in diagram 2.

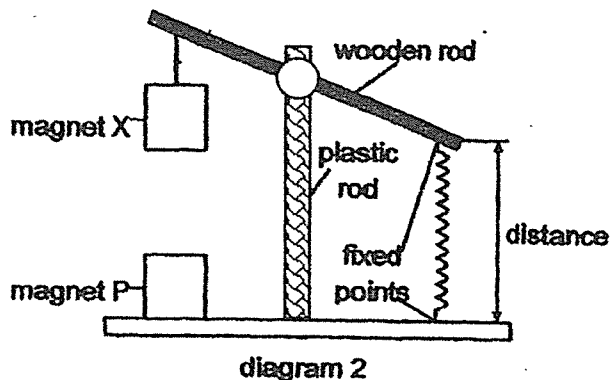
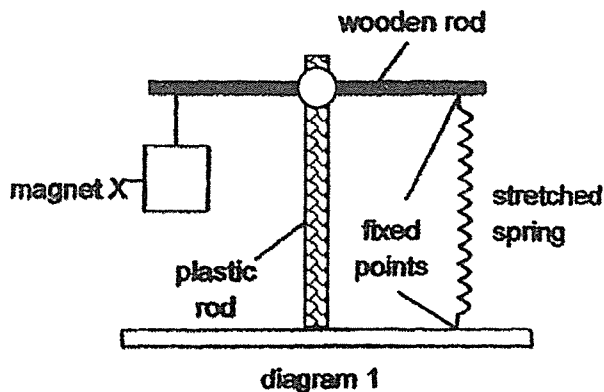

The experiment was repeated by replacing magnet P with magnets Q, R and S. The magnets are placed with the like poles facing each other. When different magnets were used, the distance measured when the wooden rod tilted were shown in the graph below.

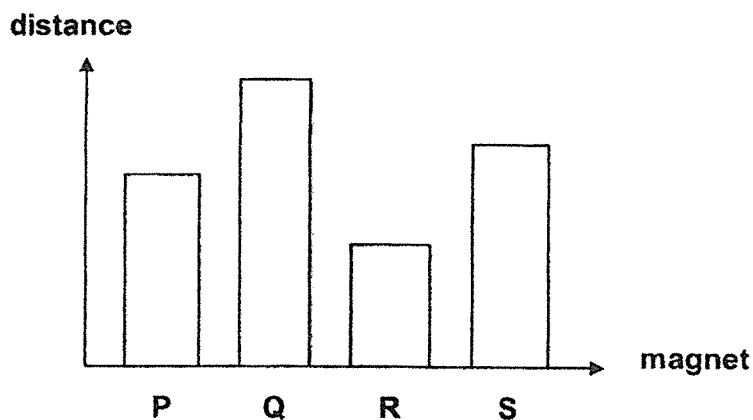

Based only on the results above, which of the following correctly shows the arrangement of the magnets?

	Greatest magnetic strength →		← Least magnetic strength	
(1)	Q	P	S	R
(2)	Q	S	P	R
(3)	R	P	S	Q
(4)	R	S	P	Q

END OF BOOKLET A

Red Swastika School
Primary 5 Science 2021
Revision Paper 2

Name: _____ () Date: _____

Class : P5 _____

Answer all the questions in the spaces provided.

29. Saminah conducted an experiment as shown in the diagram below. After one week, she noticed some dark-coloured organisms growing on the cooked bun in set-up Y only.

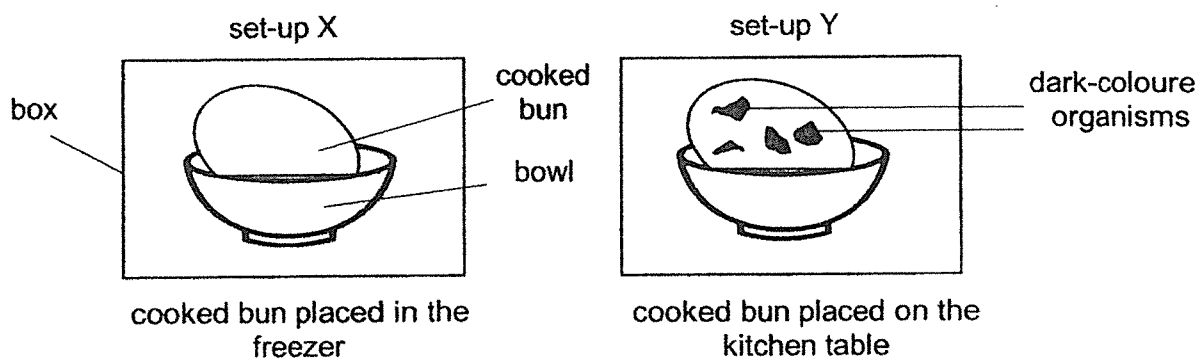

- (a) Explain why there was no dark-coloured organisms growing on the cooked bun in set-up X. (1m)

- (b) How do the dark-coloured organisms on the cooked bun reproduce? (1m)

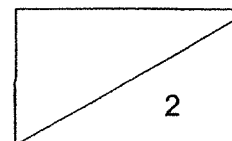

29. Saminah repeated the experiment by putting substance T in the set-up. After one week, she observed that there was less dark-coloured organisms growing on the cooked bun compared to set-up Y as shown in the diagram below.

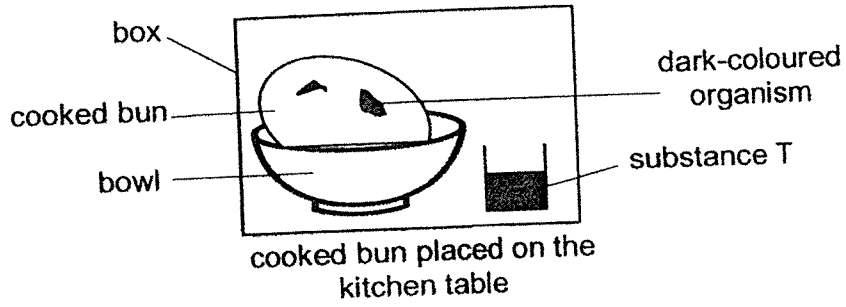

- (c) Based on the observation, what could substance T have removed from the air in the box? (1m)
-

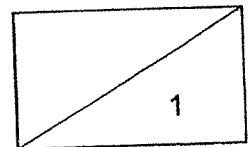

30. Kai Xin removed some food-carrying tubes of the stem from a plant as shown below.

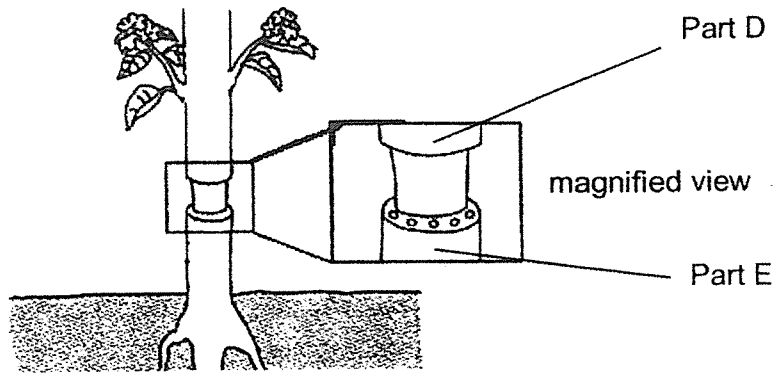

After some time, she measured the thickness of the stems and recorded it in the table below.

(a) Based on the data in the table, write "D" or "E" in the blanks to show the correct part she had observed. (1m)

Part	Day 1	Day 4	Day 7
(i)	16 cm	18 cm	20 cm
(ii)	16 cm	16 cm	16 cm

(b) Explain your answer in (a)(i). (2m)

Kai Xin wrote down four parts of a plant as shown below.

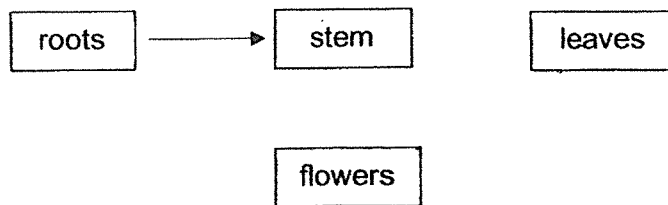

(c) Draw 2 more arrows (—————>) to show how water is transported in a plant. (1m)

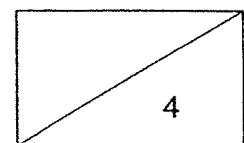

31. Henry wanted to investigate the process of digestion in the human body. The diagram shows two tubes, X and Y, with the same type of food, at the start of experiment.

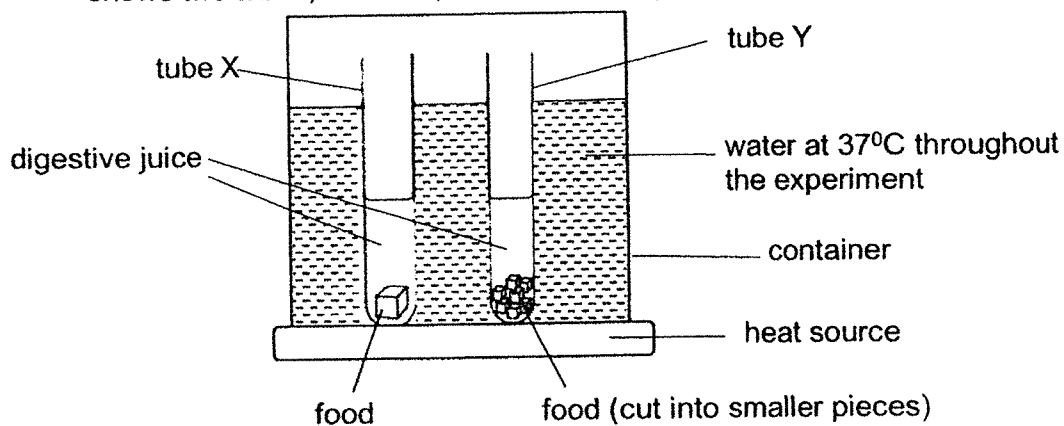

- (a) Give a reason why Henry chose a temperature of 37° C for the water in the container. (1m)

He recorded the data as shown in the table below.

Tube	Amount of digestive juice used (cm ³)	Mass of the food (g)	Total surface area of the food (cm ²)	Time taken for the food to be digested completely (min)
X	80	20	10	170
Y	80	20	30	140

- (b) Based on the table, how does surface area of the food affect the time taken to digest the food completely? (1m)

- (c) Henry wants to reduce the time taken to digest the same amount of food completely. Suggest how he can change one variable in the table to achieve his aim. (1m)

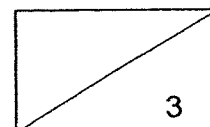

32. Julia wanted to find out more about the human circulatory system. The table below shows records of her heart rates while she was performing different activities in a day.

Activities	Resting	Walking	Running	Sleeping
beats/min	60	70	100	60
	62	75	105	65
	65	72	102	0

- (a) Julia realised that she had recorded one of her heart rates wrongly. **Circle** the wrong reading on the table above. (1m)
- (b) Explain your answer in (a). (1m)

- (c) Julia observed that her breathing rate increases when she was running. Explain why her breathing rate increases. (1m)

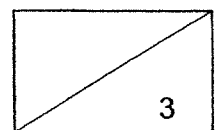

33. Mrs Tan filled two similar pots, A and B, with an equal amount of soil. She put the same type of seeds into the pots and placed them next to a window where there is plenty of sunlight and air. Mrs Tan watered the pots with an equal amount of water every day.

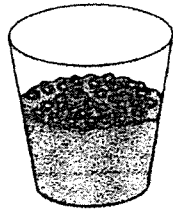

30 seeds in Pot A

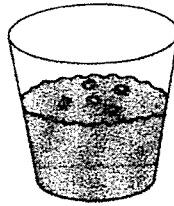

5 seeds in Pot B

- (a) Which pot, A or B, will contain taller plants after two weeks? (1m)

- (b) Explain your answer in (a). (1m)

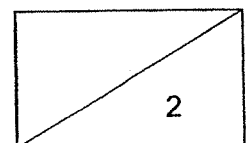

33. After one month, the seeds grew into young plants. Mrs Tan studied the growth of one plant closely at different stages, X, Y and Z as shown below.

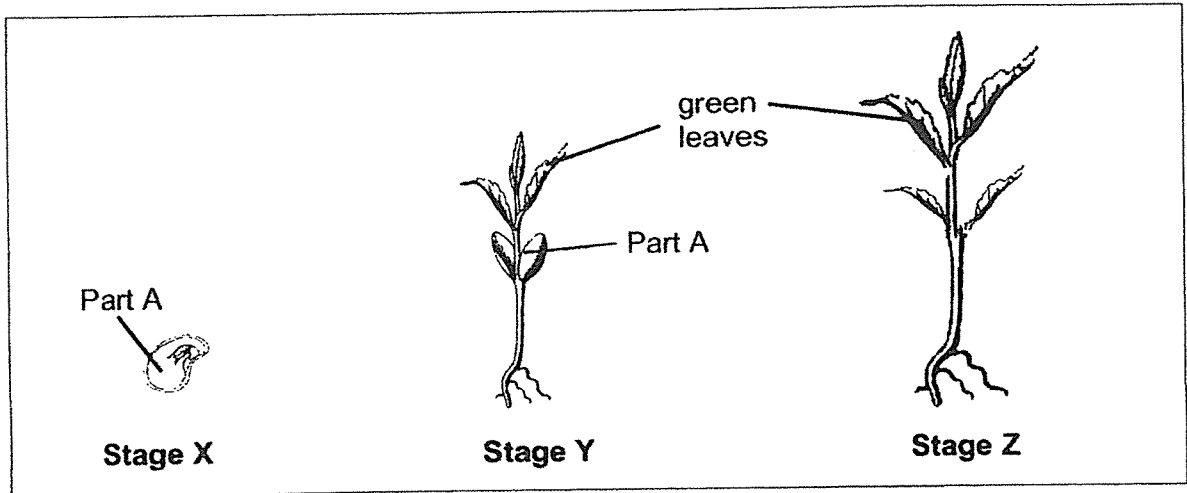

- (c) How does the plant in stage Y obtain food? (1m)

The graph below displays the mass of part A of the plant.

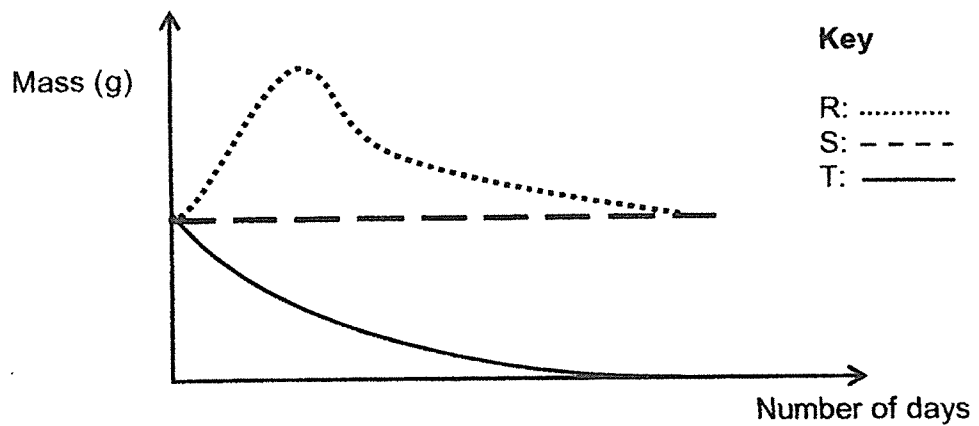

- (d) Based on the above graph, which line, R, S, or T, best represents the mass of part A of the plant from stage X to stage Z? Explain your answer. (2m)

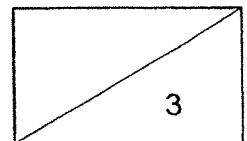

34. Charmaine studied the life cycle of organism G as shown below.

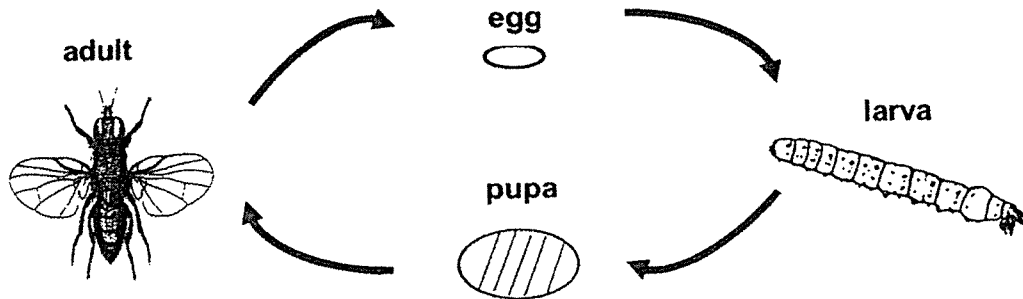

(a) Charmaine classified organism G as an insect. Based on the diagram of the adult, state two characteristics of the adult that helped her to classify it as an insect. (2m)

She studied how the temperature of the surrounding affected the life cycle of organism G. Her findings were recorded in the table below.

Temperature (°C)	Number of days for one complete life cycle
15	58
20	47
25	34
30	Q
35	16

(b) Based on the information in the table, what could be a possible value of **Q**? (1m)

(c) From Charmaine's findings, what is the relationship between temperature and the duration of one complete life cycle? (1m)

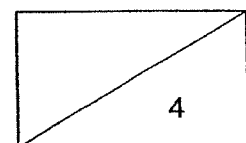

35. Shantel has a toy house with four rooms. She connected the light bulbs in the rooms using the circuit diagram shown below.

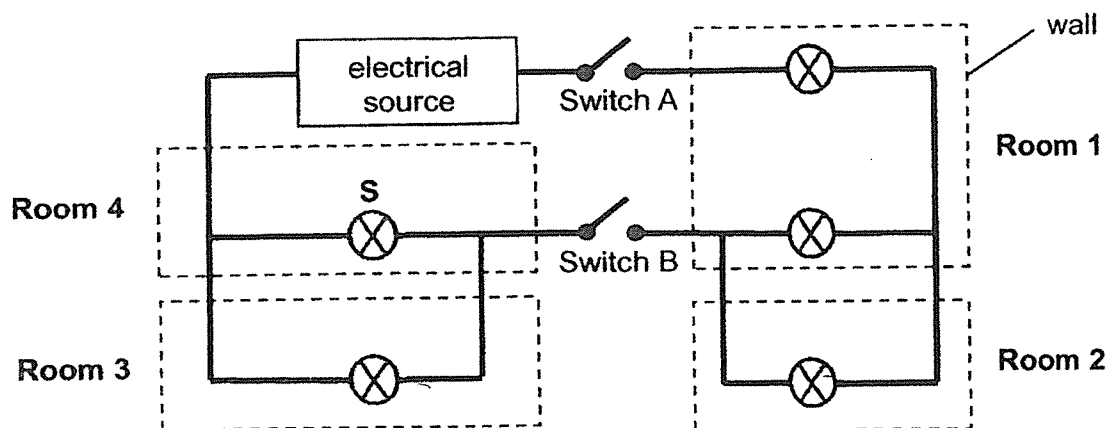

- (a) How many bulbs will light up if only switch A is closed? (1m)

- (b) Shantel closed switch A and switch B. If bulb S fuses, how many of the remaining bulbs will light up? (1m)

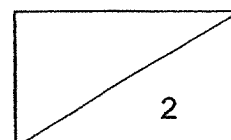

Shantel made some changes and the new circuit diagram design is shown below.

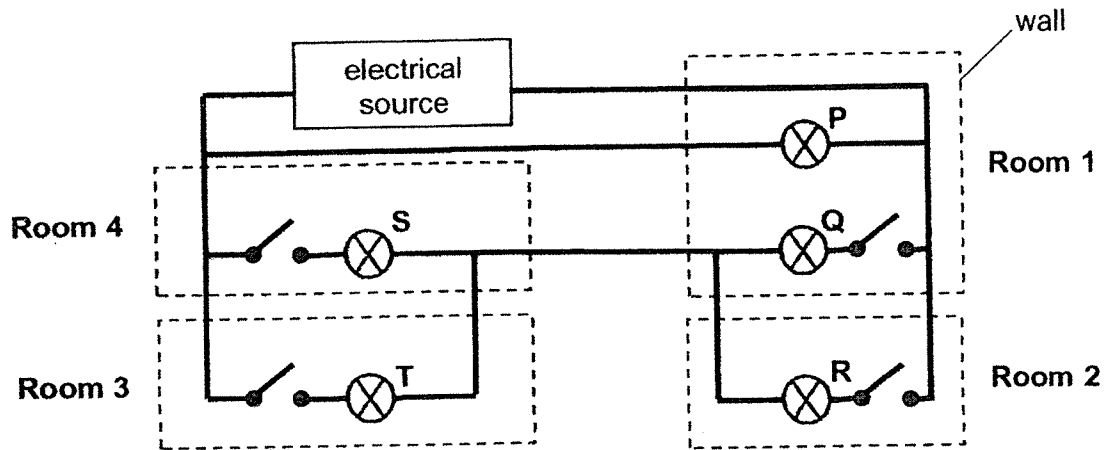

This new design allowed Shantel to make one of the bulbs a "safety" light which cannot be switched off.

- (c) Which bulb, P, Q, R, S or T, is the "safety" light? (1m)

- (d) Shantel closed three of the switches. Bulb S was one of the bulbs that lighted up. Below are some possible observations, put a tick (\checkmark) in the correct boxes. (2m)

Observations	True	False	Not possible to tell
(i) Bulb T did not light up			
(ii) Bulb Q lighted up			

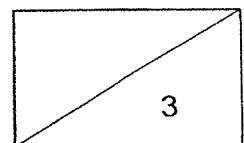

36. Three identical containers, X, Y and Z, containing the same amount of water at different temperatures were placed on a table. Sarah made the following observation after five minutes.

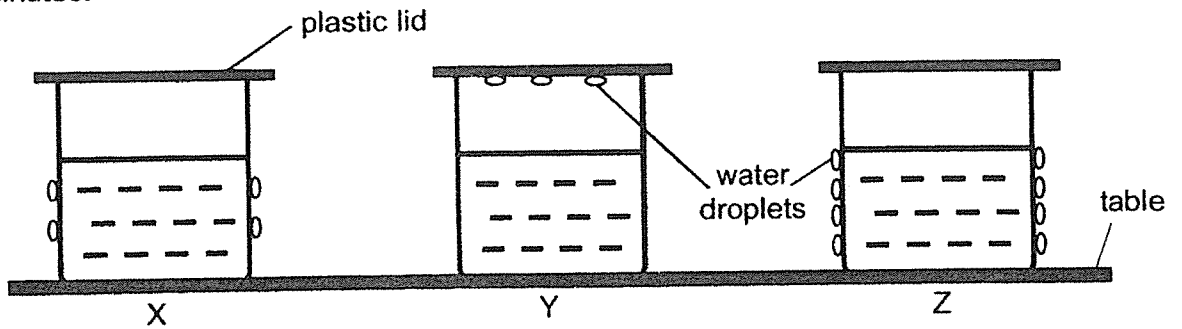

- (a) Arrange the containers, X, Y and Z, based on the temperature of the water in them, from the lowest temperature to the highest temperature. (1m)

- (b) Describe how the water droplets formed on the outer surface of beaker Z. (2m)

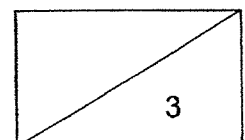

37. After a heavy rainfall, Hassim noticed that a puddle of water formed on the ground. As time passed, the puddle gradually became smaller. He measured the width of the puddle at different timings of the day and recorded them in his notebook. The width of the puddle at 11 a.m. is shown in the diagram.

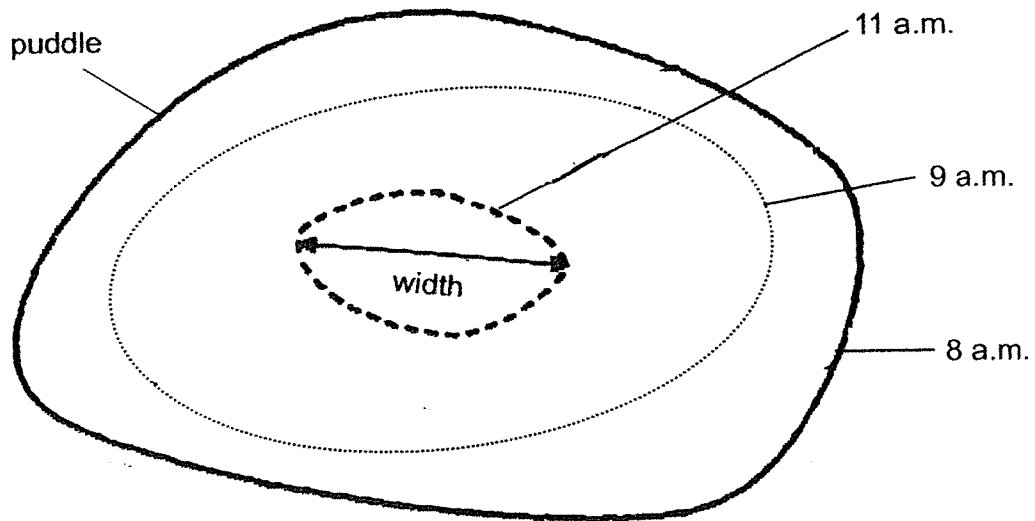

- (a) Draw a ring in the diagram above to show the size of the puddle at 10 a.m.. (1m)
- (b) If no water was absorbed into the ground, explain why the puddle of water became smaller over time. (1m)

Study the graph below. Line A shows how the puddle of water of width 100 cm changed over time.

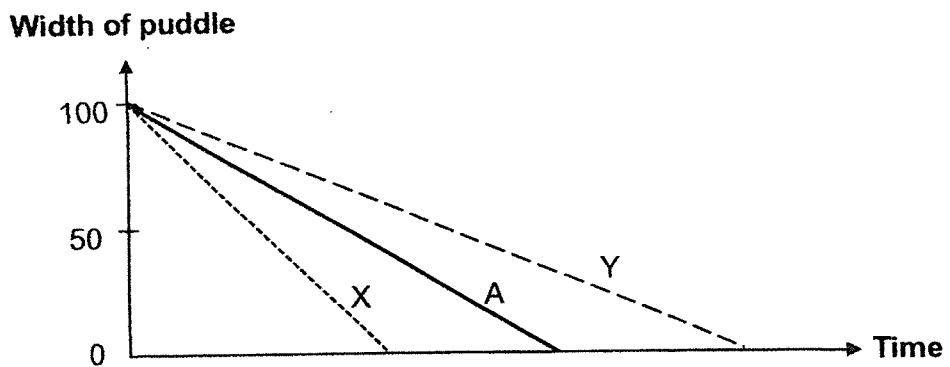

- (c) Which line, X or Y, shows how the puddle of water of width 100 cm will change on a hotter day? (1m)

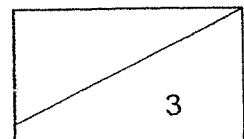

38. Harold conducted an experiment in a dark room using the set-up below. He wanted to find out how much light is reflected by material A.

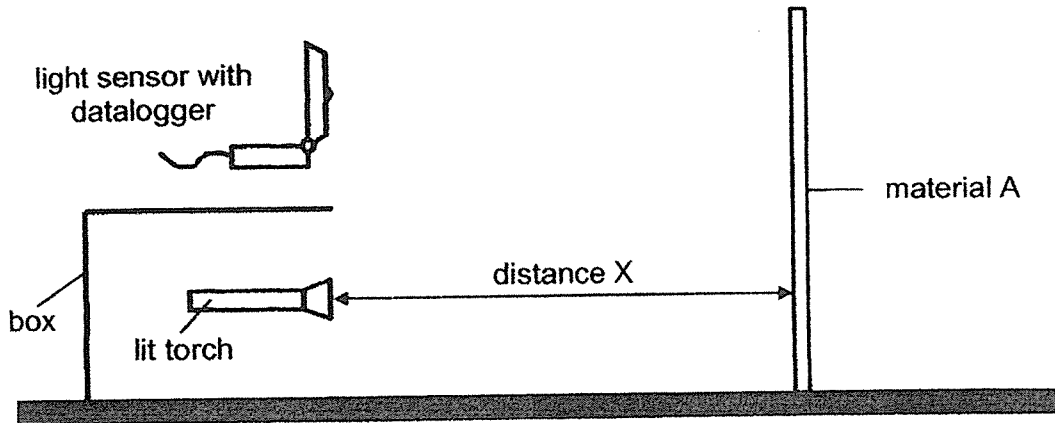

- (a) For the experiment to work, give an example of the material for the box. (1m)
-
- (b) For the experiment to work, what property must the material in part (a) have? (1m)
-
- (c) Harold wanted to record the result as shown in the table. However, he mixed up the values for the amount of light measured by the datalogger.

Using the values of 100, 150 and 200, write down the correct answers in the boxes in the table below. (1m)

Distance X (cm)	10	20	30
Amount of light measured by datalogger (unit)	(i)	(ii)	(iii)

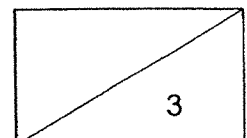

39. Victoria wants to build a shelf above her kettle to store plastic boxes. She does not want the plastic boxes to be affected by the heat given off by the kettle.

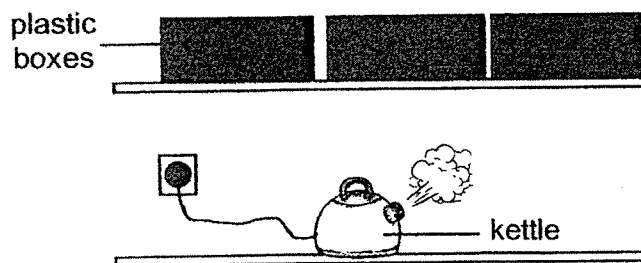

She conducted the following experiment to find out a suitable height to build the shelf. She filled a glass container with boiling water at 100°C and kept the water boiling throughout the experiment. She measured the temperature of air at various distance, X , from the water surface.

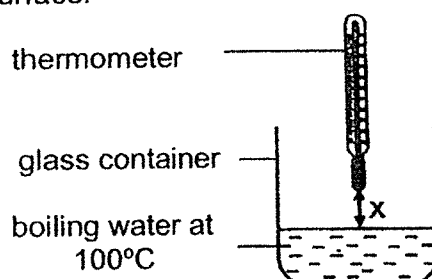

The result is recorded in the table below.

Distance X (cm)	15	20	25	30	35
Temperature of air ($^{\circ}\text{C}$)	58	40	30	30	30

- (a) Victoria wants the plastic boxes to be least affected by the heat from the kettle. Based on the results of the experiment, what is the lowest height from the kettle to build the shelf? Explain why. (2m)

Lowest height: _____ cm

Explanation: _____

- (b) Explain how using a glass container allowed Victoria to obtain a more accurate result. (1m)



40. Study the diagram below. When the switch in the circuit was closed, magnet Q moved from position R to position S as indicated by distance Y.

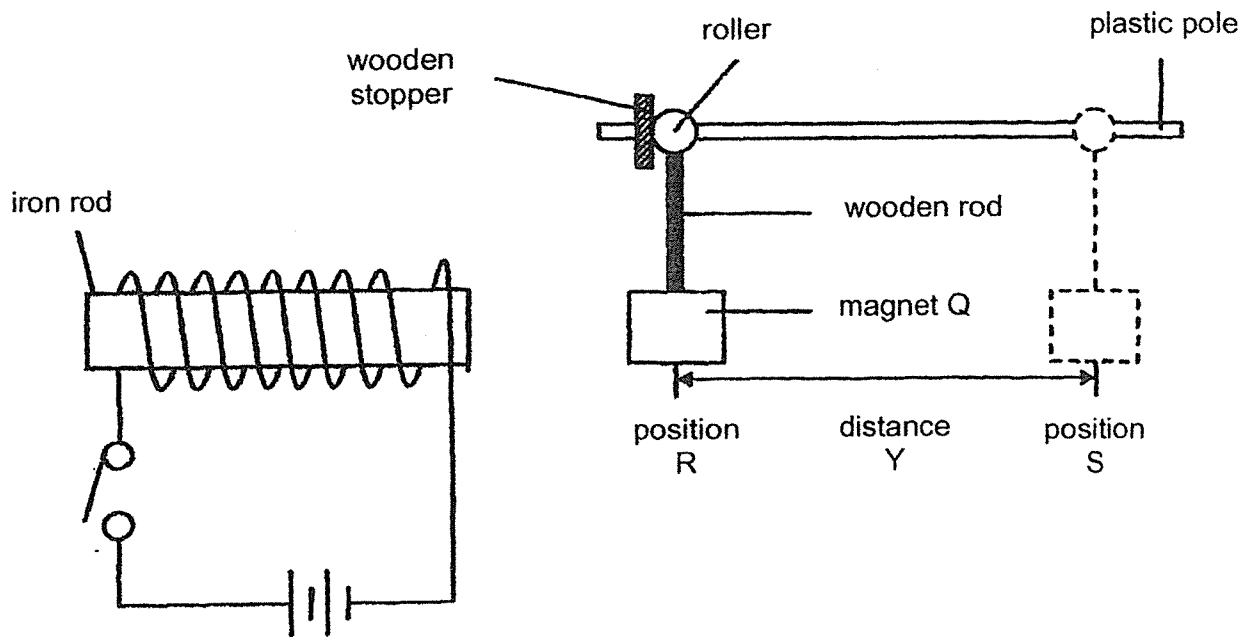

- (a) Describe how closing the switch caused magnet Q to move. (2m)
- _____
- _____
- _____
- (b) Without removing or replacing any items in the set-up above, suggest two changes that can be made to the above set-up such that "distance Y" can be increased. (2m)
- Change 1: _____
- _____
- Change 2: _____
- _____
- (c) Magnet Q is replaced by block P. When the switch was closed, block P did not move. Give an example of a material that is used to make block P. (1m)

**END OF BOOKLET B
PLEASE CHECK YOUR ANSWERS.**

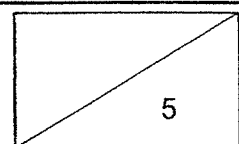

ANSWER KEY

YEAR : 2021
LEVEL : PRIMARY 5
SCHOOL : RED SWASTIKA SCHOOL
SUBJECT : SCIENCE
TERM : REVISION PAPER 1

PAPER 1

Q1	4	Q2	3	Q3	2	Q4	2	Q5	1
Q6	4	Q7	4	Q8	2	Q9	1	Q10	3
Q11	4	Q12	2	Q13	4	Q14	4	Q15	1
Q16	2	Q17	2	Q18	1	Q19	4	Q20	2
Q21	3	Q22	2	Q23	3	Q24	3	Q25	2
Q26	1	Q27	4	Q28	3				

PAPER 2

Q29	(a)	The bun in Set-up X was placed in the freezer which kept the bun cold, not allowing mould, known as dark-coloured organism to grow due to a missing factor, warmth.	
	(b)	The dark-coloured organisms on the cooked buns feed on the bread to grow and reproduce by spores.	
	(c)	Water vapour	
Q30	(a)	(i)	D
		(ii)	E
	(b)	Food made by the leaves could not be passed transported the plant through the food-carrying tubes and was collected and unable to travel so it swelled up and became thicker at D.	
(c)	Stem → leaves ↓ Flowers		
Q31	(a)	37°C is the temperature of our body so he used 37°C for the water in order to create what would happen if it was in our body.	
	(b)	The more surface area exposed, the less time taken it	

		will take to be digested.			
	(c)	He can increase the total surface area of the food.			
Q32	(a)	**Circle** (0)			
	(b)	If our heartbeat reaches zero, it means that the heart cannot help us pump oxygen into our body, causing us to die.			
	(c)	When she run, her heart pumps most of the blood to her legs so she breathes more in order to allow her heart pump more oxygen to her legs			
Q33	(a)	A			
	(b)	30 seeds in A will make the plants overcrowd so the plants will grow taller to reach out for more sunlight, space, nutrients, water.			
	(c)	The plant has already grown its leaves so the leaves will photosynthesis for the plant.			
	(d)	T. Part A provides the seed with food when it germinating but eventually runs out of food when the leaves grow and will drop of the plant.			
Q34	(a)	Organism G has 3 body parts and 3 pairs of legs.			
	(b)	23°C			
	(c)	The higher the temperature is, the lesser the number of days it will take to complete a life cycle.			
Q35	(a)	D			
	(b)	4			
	(c)	P			
	(d)	<table border="1"> <tr> <td>(i)</td> <td>Not possible to tell <input checked="" type="checkbox"/></td> </tr> <tr> <td>(ii)</td> <td>True <input checked="" type="checkbox"/></td> </tr> </table>	(i)	Not possible to tell <input checked="" type="checkbox"/>	(ii)
(i)	Not possible to tell <input checked="" type="checkbox"/>				
(ii)	True <input checked="" type="checkbox"/>				
Q36	(a)	Z, X, Y			
	(b)	Water vapour in the surrounding air touched the cooler outer surface of Z which had lost heat to the cold water in it and condensed into water droplets.			

Q37	(a)		
	(b)	The water droplet gained heat from the sun and the surrounding air and evaporated into water vapour	
	(c)	X.	
Q38	(a)	Metal	
	(b)	Must not allow light to pass through	
	(c)	(i)	200
		(ii)	150
(iii)		100	
Q39	(a)	25cm Explanation: 25cm, 30cm, 35cm all had same amount of heat transferred to the plastic boxes. Thus, all the temperature is constant.	
	(b)	Plastic would melt at 100°C	
Q40	(a)	When the switch is closed, the iron rod becomes a electromagnet and repels magnet Q. As the magnetic force is strong, Q is repelled and moved backwards.	
	(b)	Change 1	Add more batteries to the iron rod set-up.
		Change 2	Add more coils around the iron rod.
	(c)	Plastic	