



RAFFLES GIRLS' PRIMARY SCHOOL

Practice Paper 4

Name : _____ Index No.: _____ Class: P5___ Date: _____

SCIENCE

ATT: 1 h 30 min

SECTION A (25 x 2 marks)

For each question from 1 to 25, four options are given. One of them is the correct answer. Make your choice (1, 2, 3 or 4). Shade the correct oval (1, 2, 3 or 4) on the Optical Answer Sheet (OAS) provided.

1. The diagrams below show the male and female human reproductive systems.

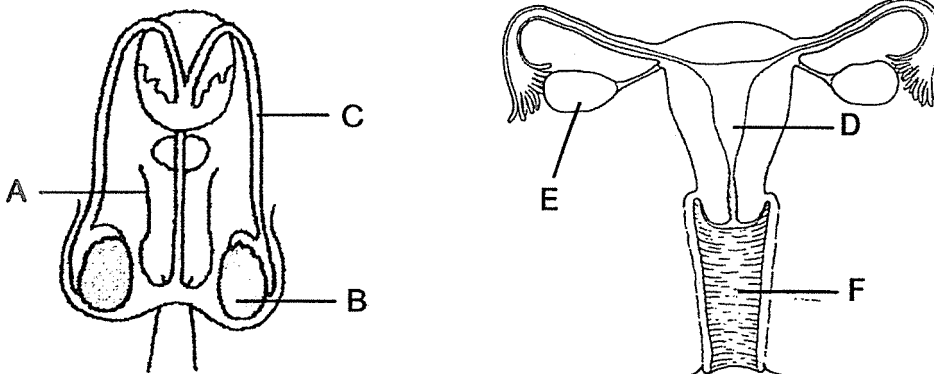

Which of the following states the parts that perform the functions stated correctly?

	production of female reproductive cells	production of male reproductive cells
(1)	B	F
(2)	D	A
(3)	F	C
(4)	E	B

2. A disease carrier is a person who has inherited a genetic trait of the disease but displays no symptoms for the disease.

The diagram below shows information of three generations of Sam's family on the inheritance of the genetic trait for disease X.

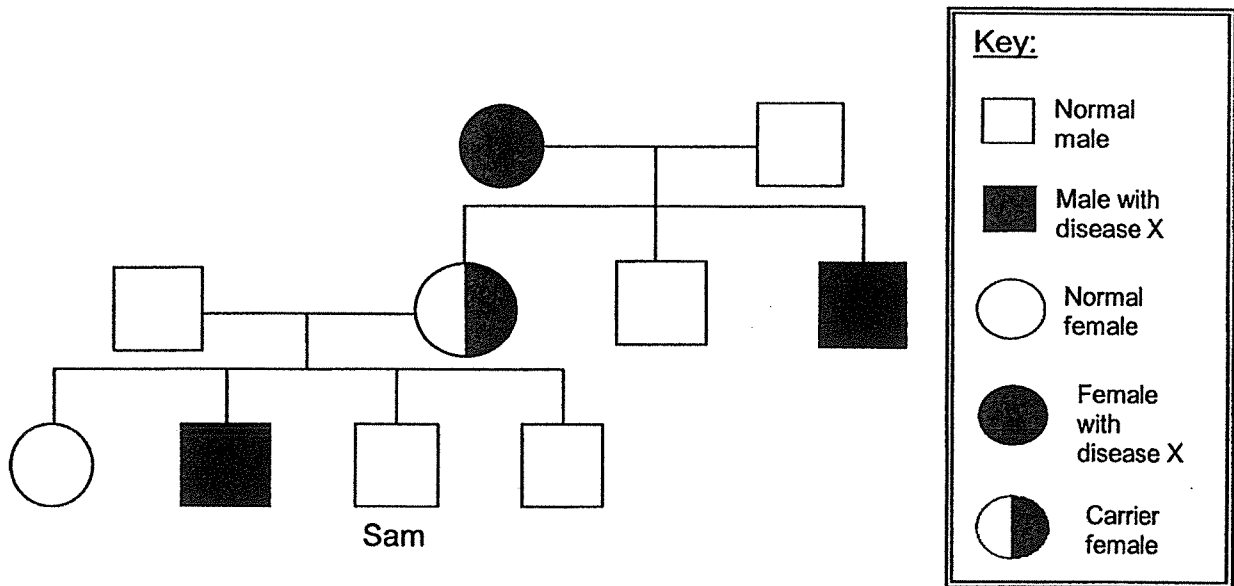

Based on the information above, which of the following statement(s) is/are likely to be correct?

- A Sam's children could possibly inherit the disease.
- B Both of Sam's grandparents display symptoms of disease X.
- C Sam's mother inherited the gene of disease X from his grandmother.
- D The genes of disease X are passed on to only the female members of the family.

- (1) C only
- (2) A and C only
- (3) B and C only
- (4) B, C and D only

3. The flow chart below shows how organisms A, B, C and D are grouped.

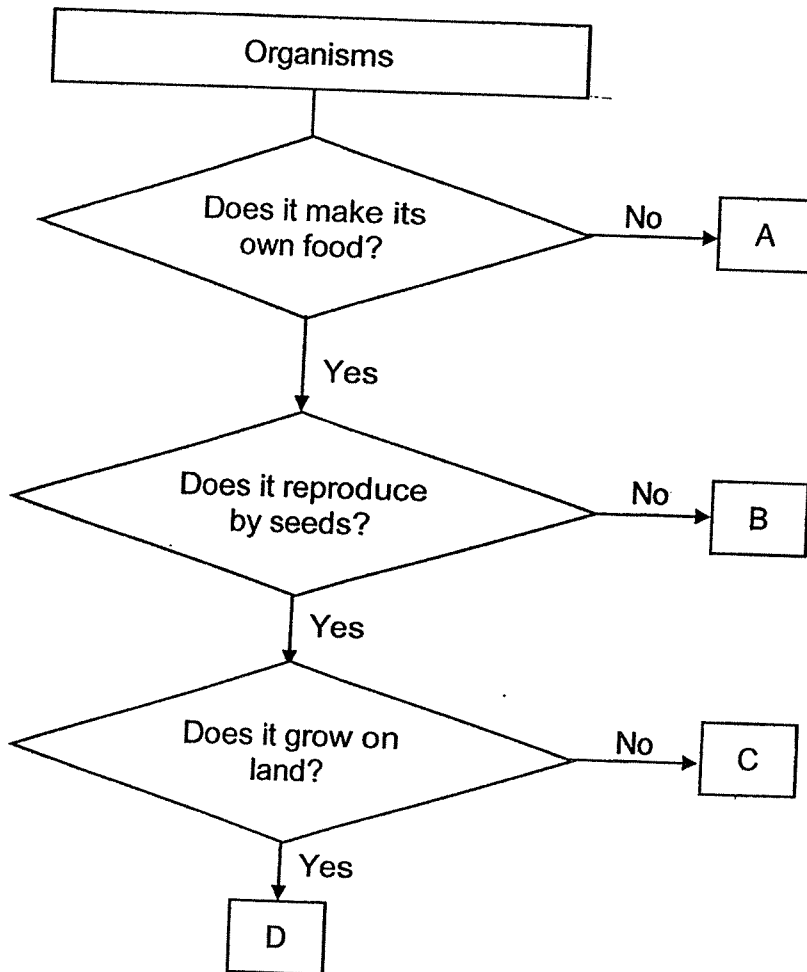

The table below shows some characteristics of organisms P, Q and R. A tick (✓) indicates the presence of the characteristic in the organism.

Characteristics	Organism P	Organism Q	Organism R
Has chlorophyll	✓	✓	
Grows on land	✓		✓
Has fruits	✓	✓	
Reproduces by spores			✓

Based on the information above, which of the following organism(s) share the same characteristics as organism C?

- (1) Q only
- (2) P and Q only
- (3) P and R only
- (4) P, Q and R

4. Cassandra wanted to find out the effect of overcrowding on the growth of seedlings. She used identical pots for her experiment and watered them daily with the same amount of water.

Set-up	Number of seedlings	Type of seeds	Location
A	13	P	Field
B	7	Q	Room
C	7	P	Field
D	13	Q	Room
E	35	Q	Field

Which of the following set-ups should Cassandra use in order to ensure a fair test?

- (1) A and C only
- (2) D and E only
- (3) A, C and D only
- (4) B, D and E only

5. Meera filled two identical tanks, P and Q, with same amount of water and plants as shown in the diagrams below. She placed tank P in a brightly lit room and tank Q in a dark room.

In a brightly lit room

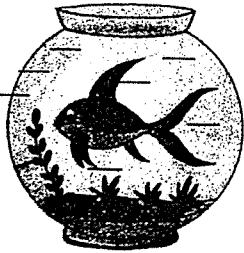

Tank P



In a dark room



Tank Q

Meera recorded the time taken for the fish in each tank to swim to the surface of the water to receive more air.

Which of the following most likely shows Meera's observations?

Time taken for the fish to swim to the surface of the water (minutes)	
P	Q
(1) 15	15
(2) 15	10
(3) 15	30
(4) 14	15

6. The diagram below shows the skeletal system.

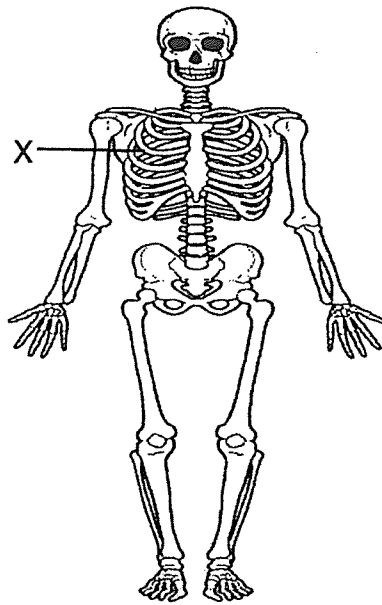

Part X protects the _____.

- (1) lungs and heart
- (2) heart and stomach
- (3) lungs, heart and small intestine
- (4) heart, stomach and small intestine

7. Gerald started his exercise session with a brisk walk and then he took a rest before he continued with a few sets of jumping jacks. Which of the following graphs best represents his heart rate from the start to the end of his exercise session?

(1)

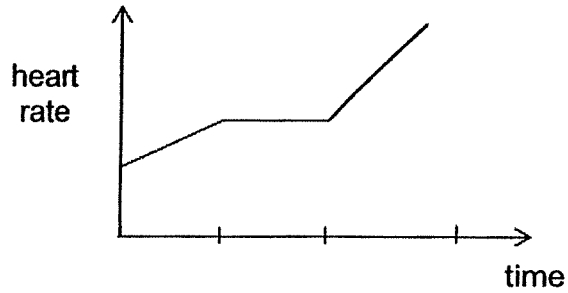

(2)

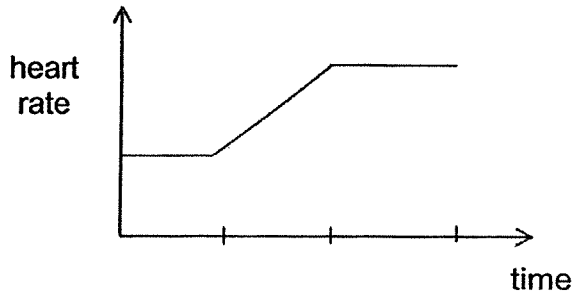

(3)

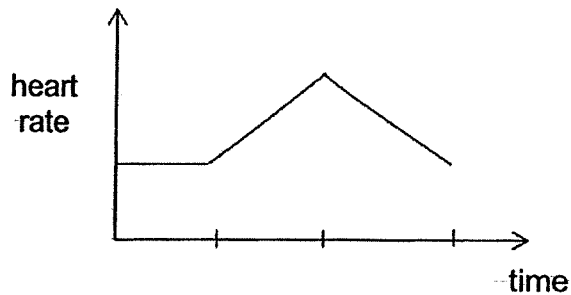

(4)

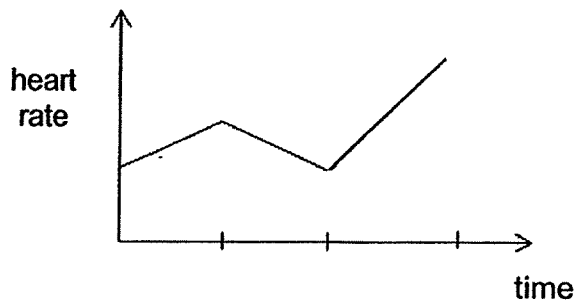

8. The diagram below shows two different types of cells, X and Y.

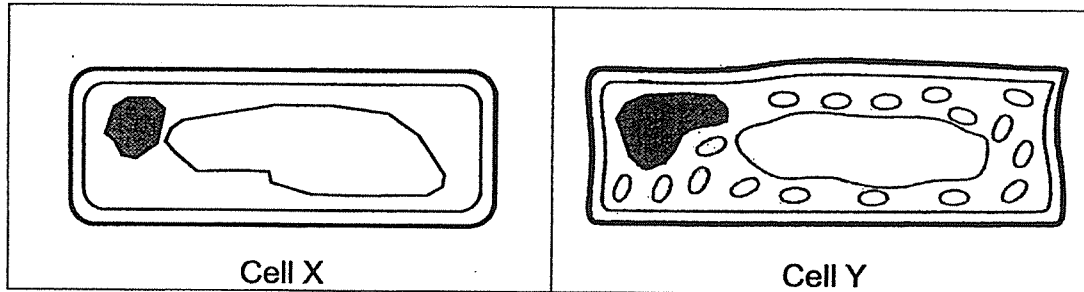

Which of the following statements about cells X and Y are most likely to be correct?

- A Both cell X and cell Y are plant cells.
- B Cell Y is most likely to be found in the leaf.
- C Cell X is an animal cell, while Cell Y is a plant cell.
- D Both cell X and cell Y are able to make food.

- (1) A and B only
- (2) A and D only
- (3) B and C only
- (4) C and D only

9. The diagrams below show human systems, X, Y and Z.

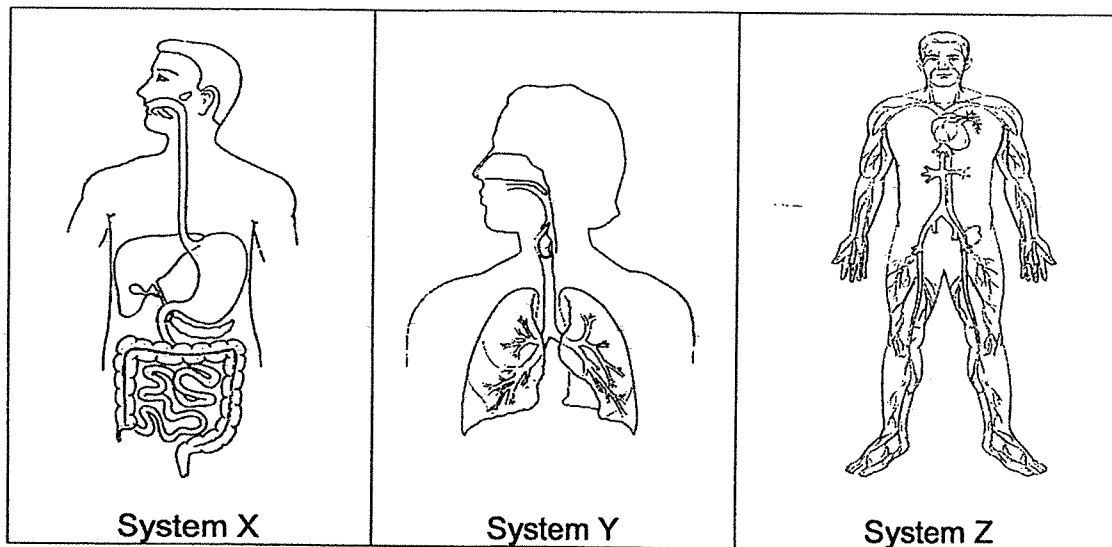

Which of the following systems work(s) to supply oxygen to the body and remove carbon dioxide from the body?

- (1) System X only
- (2) System Y only
- (3) Systems Y and Z only
- (4) Systems X, Y and Z

10. The diagram below shows how blood flows in certain parts of the body after a meal.

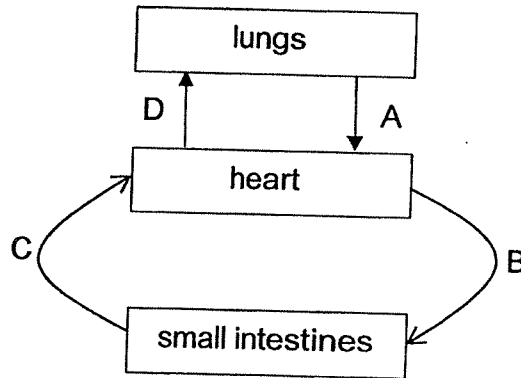

Same amount of blood samples were taken from parts A, B, C and D.

Which of the following is correct?

	Amount of oxygen in blood	Amount of digested food in blood
(1)	Blood A has more than blood B.	Blood B has less than blood C.
(2)	Blood A has less than blood C.	Blood B has more than blood C.
(3)	Blood D has more than blood B.	Blood B has less than blood C.
(4)	Blood D has less than blood C.	Blood B has more than blood C.

11. The diagram below shows a plant placed in a container containing red-coloured water. The magnified cross-section of the root is shown below.

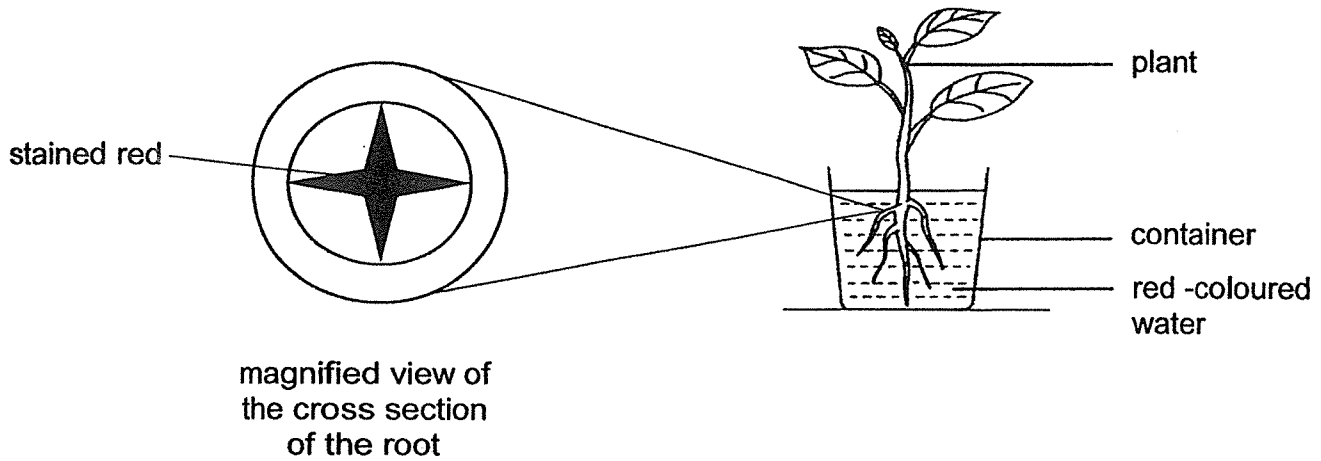

Which of the following correctly explains the function of the part that is stained red?

- (1) It keeps the plant upright.
- (2) It stores food made by the plant.
- (3) It transports food to all parts of the plant.
- (4) It transports water to all parts of the plant.

12. Jamie removed the food-carrying tubes of a plant as shown in the diagram below. She left the plant under the sun and watered it daily.

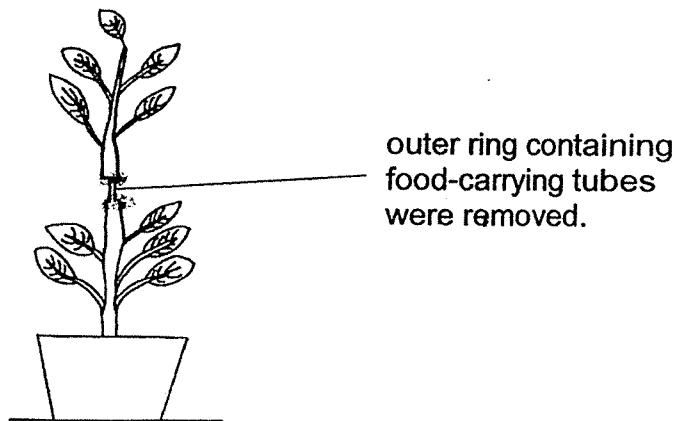

Based on the information above, which of the following diagrams best represents the appearance of the above stem after one week?

(1)

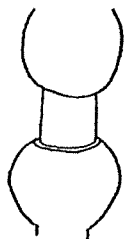

(2)



(3)

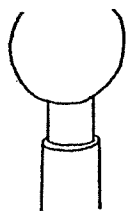

(4)

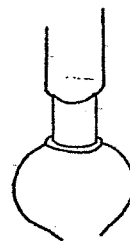

13. The table below shows the melting point and boiling point of four different substances A, B, C and D.

Substance	Melting point (°C)	Boiling point (°C)
A	24	74
B	0	100
C	13	55
D	80	220

Which of these substance(s) is/are liquid(s) at 30 °C and gas(es) at 75 °C?

- (1) C only
 - (2) A and C only
 - (3) B and D only
 - (4) A, B and C only
14. The diagram shows the water cycle.

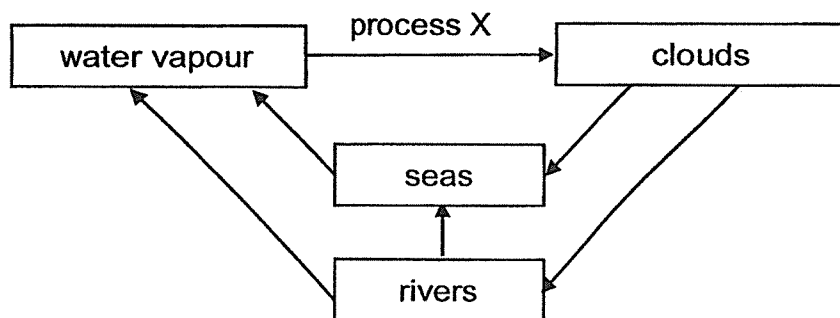

Which of the following describes process X correctly?

	Heat transfer	Process X
(1)	heat loss	condensation
(2)	heat loss	evaporation
(3)	heat gain	condensation
(4)	heat gain	evaporation

15. Study the diagram below, the dog is able to see the bone.

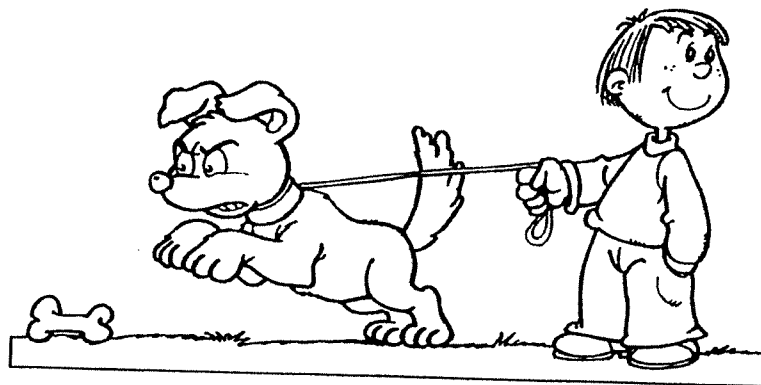

Which of the following correctly shows the path of light that makes it possible for the dog to see the bone?

<p>(1)</p> A diagram showing the sun, dog, and boy. An arrow points from the sun to the dog, and another arrow points from the dog to the bone.	<p>(2)</p> A diagram showing the sun, dog, and boy. An arrow points from the sun to the bone, and another arrow points from the bone to the dog.
<p>(3)</p> A diagram showing the sun, dog, and boy. An arrow points from the sun to the bone, and another arrow points from the dog to the bone.	<p>(4)</p> A diagram showing the sun, dog, and boy. An arrow points from the sun to the dog, and another arrow points from the bone to the dog.

16. Mary placed a wooden cube and a circular disc under a lamp as shown below and observed the shadow cast on screen P. She changed the position of the objects and observed the shadow casted on screen Q.

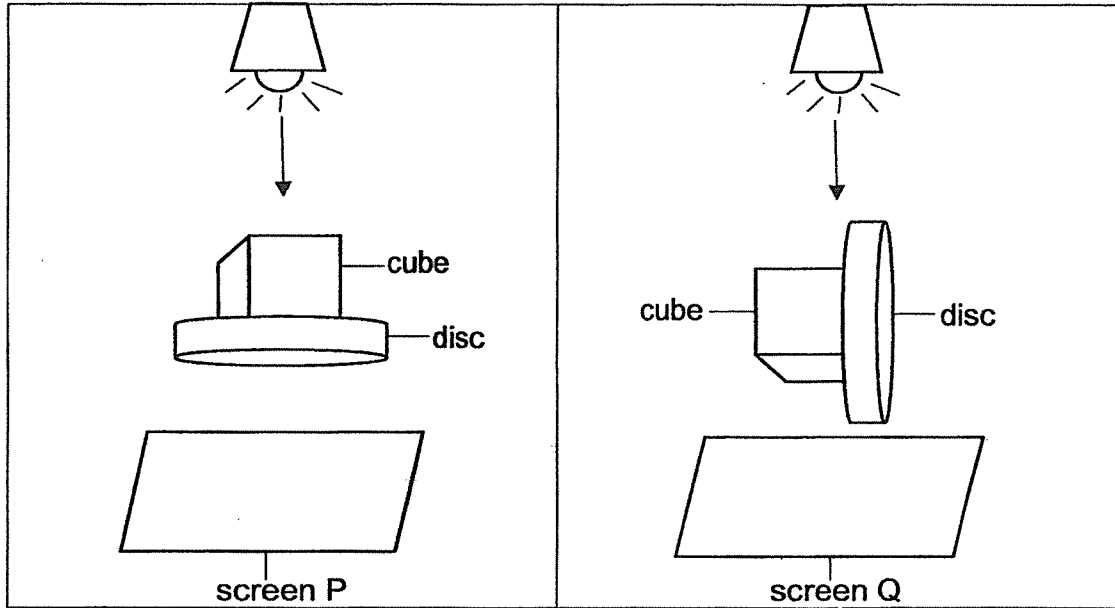

Which of the following shadows shows the shadows cast on screen P and Q?

	Screen P	Screen Q
(1)		
(2)		
(3)		
(4)		

17. The graph below shows how the length of Raju's shadow changes over a period of time when he walks near a street lamp at night.

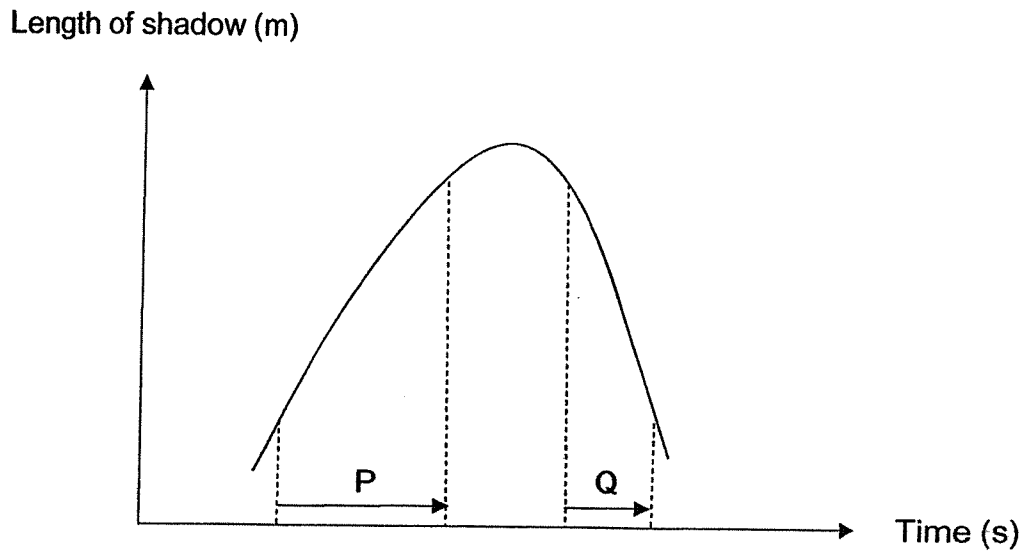

Which of the following correctly shows the walking path that Raju took during periods P and Q?

	Period P	Period Q
(1)	towards the lamp	away from the lamp
(2)	towards the lamp	towards the lamp
(3)	away from the lamp	towards the lamp
(4)	away from the lamp	away from the lamp

18. The diagram below shows some ice cubes in a glass of water.

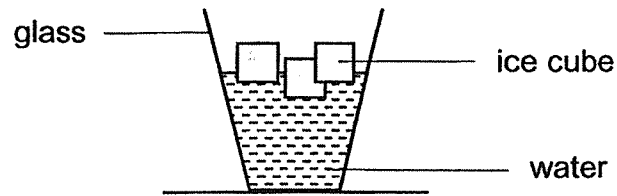

After ten minutes, the ice cubes melted completely.
Which of the following statement(s) correctly explain(s) why the ice cube melted?

- A The water gained heat from the ice.
 - B The ice gained heat from the water.
 - C The ice lost heat to the surrounding air.
 - D The surrounding air lost heat to the ice cubes.
- (1) B only
(2) A and C only
(3) B and D only
(4) A, C and D only

19. Tom prepared a set-up as shown below. He poured 250 ml of liquid X into the beaker and recorded the time taken for it to boil.

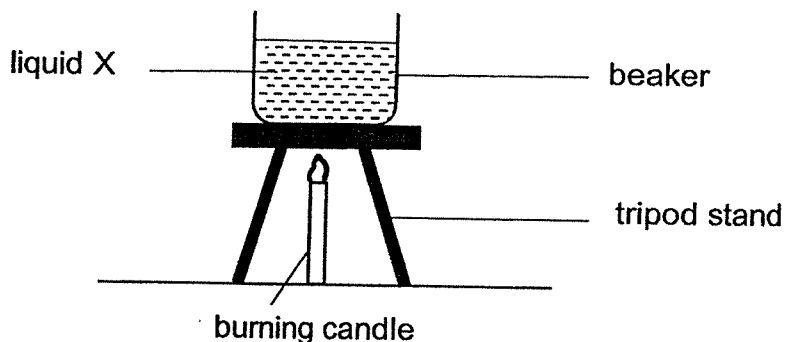

He then repeated the experiment using the same amount of liquids Y and Z, and recorded the time taken for liquids X, Y and Z to boil in the table below.

Liquid	Ability to gain heat	Time taken for it to boil (min)
X	Poor	15
Y	Good	15
Z	Very good	15

After the experiment, he realised that he used different number of heat sources for each repeated experiment.

Which of the following most likely shows the number of heat source he had used to heat up liquids X, Y and Z?

Number of heat source(s)			
	X	Y	Z
(1)	1	2	3
(2)	1	3	2
(3)	3	1	2
(4)	3	2	1

20. Helen placed 3 pieces of wax, of different quantity, at positions P, Q and R on steel rods of identical length as shown below. Heat is applied at point X. She recorded the time taken for the wax to melt completely.

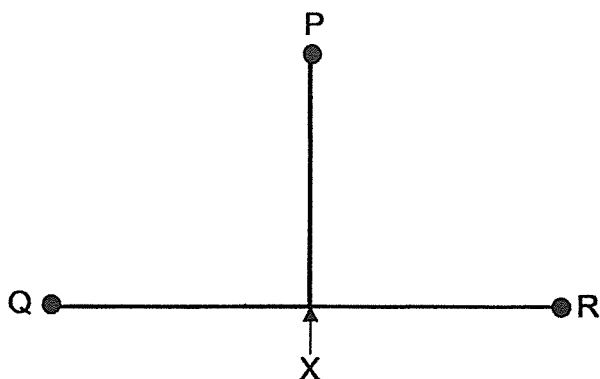

Wax at position	Time taken for the wax to melt completely (minutes)
P	10
Q	15
R	20

Which of the following correctly explains the different amount of time taken for each piece of wax to melt?

- (1) Different amounts of heat were conducted to the wax at positions P, Q and R, to melt them.
- (2) The wax at position Q gained less amount of heat to melt than the wax at positions P and R.
- (3) The wax at position R gained more amount of heat to melt than the wax at positions P and Q.
- (4) The wax at position P required the least amount of heat to melt as it was the smallest piece.

21. Which one of the following circuit arrangements will only have two bulbs lit up?

(1)

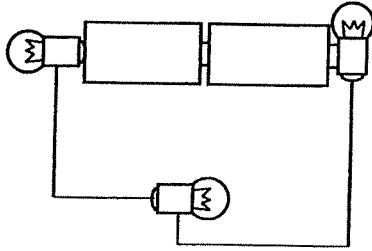

(2)

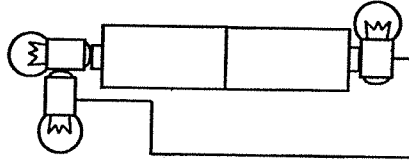

(3)

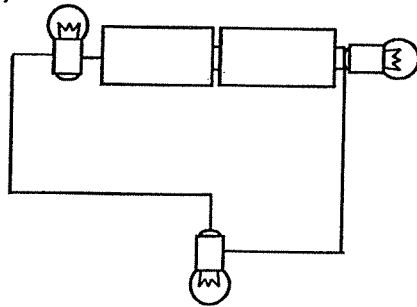

(4)

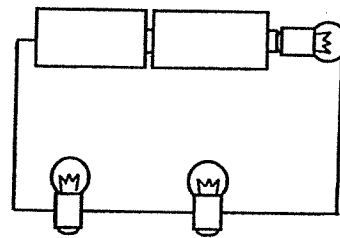

22. Study the electric circuits as shown below.

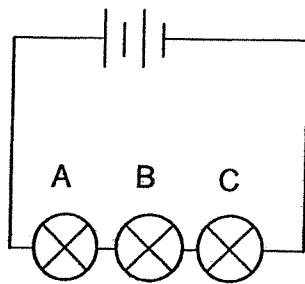

Circuit X

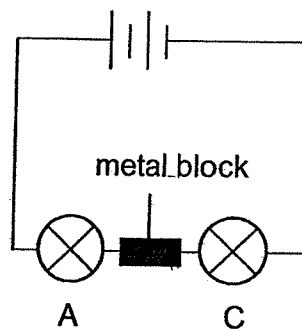

Circuit Y

If bulb B is removed and replaced with a metal block as shown in circuit Y, what will happen to bulbs A and C?

- (1) Bulb C will not light up.
- (2) Bulb A will become brighter than C.
- (3) Bulb A will become dimmer than C.
- (4) Bulbs A and C will light up with equal brightness.

23. Which of the following circuits allows the most number of bulbs to light up when only one switch is closed?

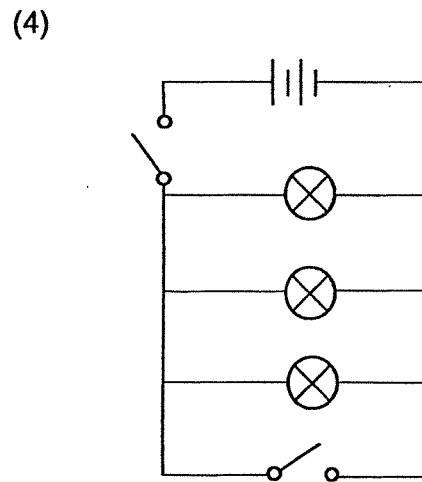
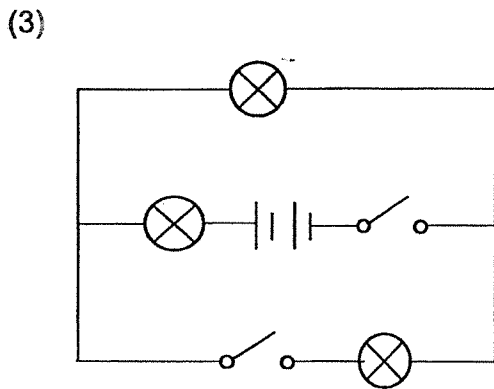
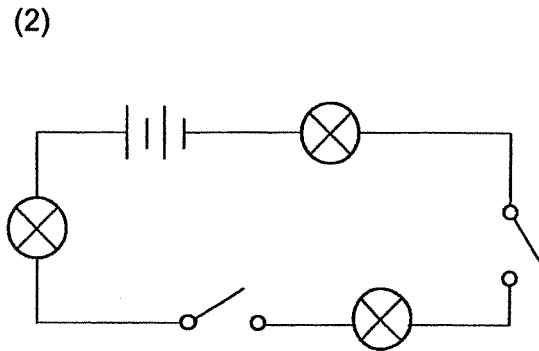
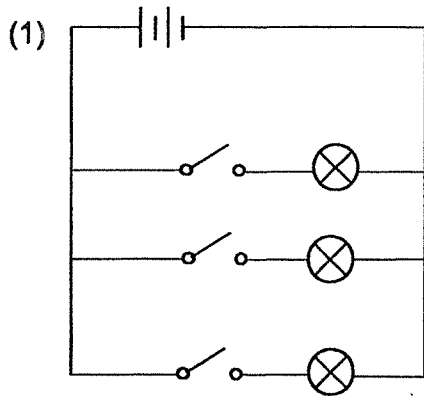

24. Siti arranged three magnets AB, CD and EF and an iron bar XY as shown below.

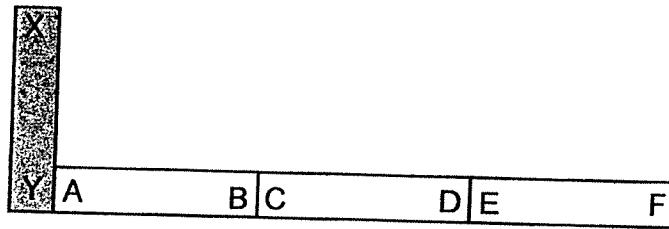

Which of the following arrangements is possible?

(1)

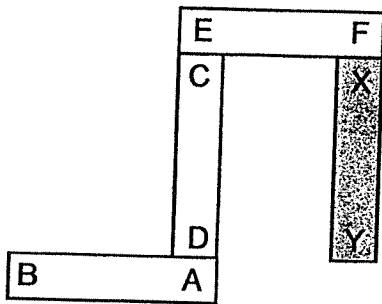

(2)

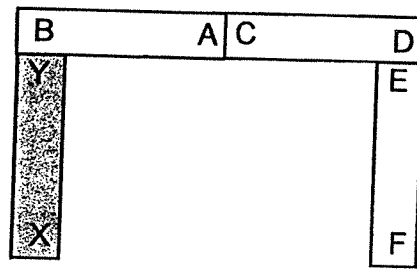

(3)

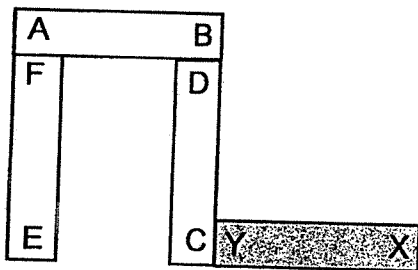

(4)

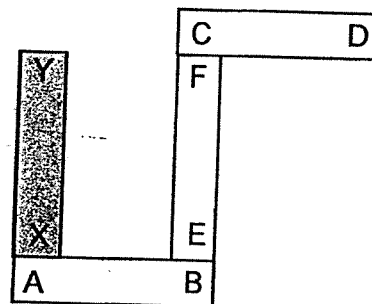

25. Magnets W, X, Y and Z are hung above a tray of iron pins. The number of pins attracted by each magnet is shown in the diagram below.

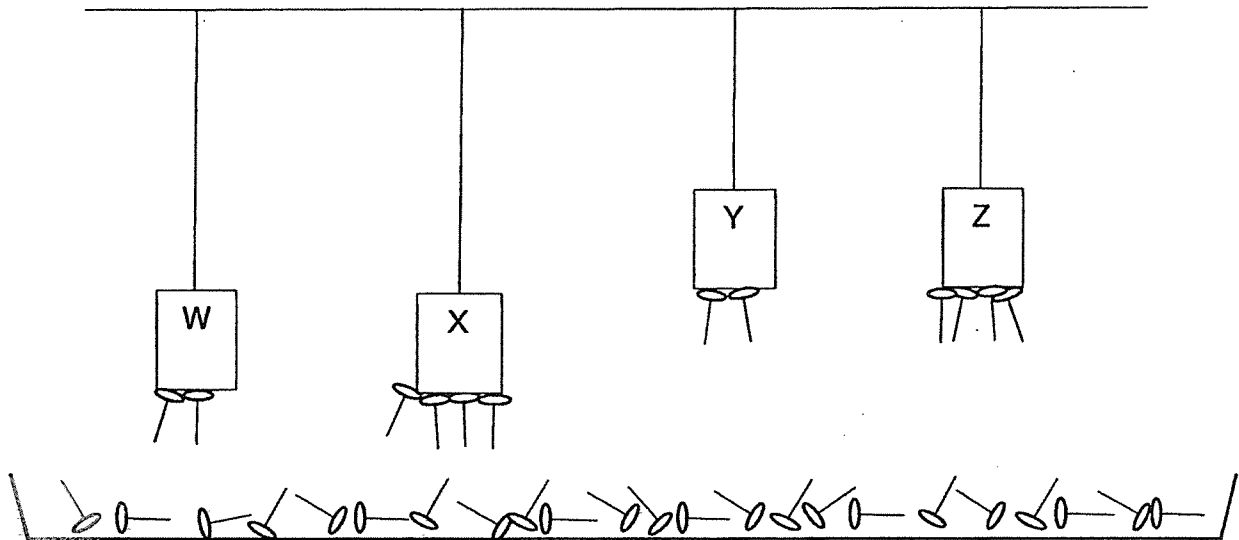

Which one of the following magnets is the strongest?

- (1) W
- (2) X
- (3) Y
- (4) Z

Name: _____ Index No: _____ Class: P5 _____

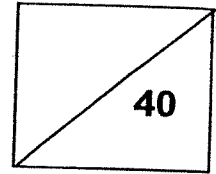

SECTION B (40 marks)

For questions 26 to 38, write your answers clearly in the spaces provided.
The number of marks is shown in brackets [] at the end of each question or part question.

26. The diagram below shows the human female reproductive system.

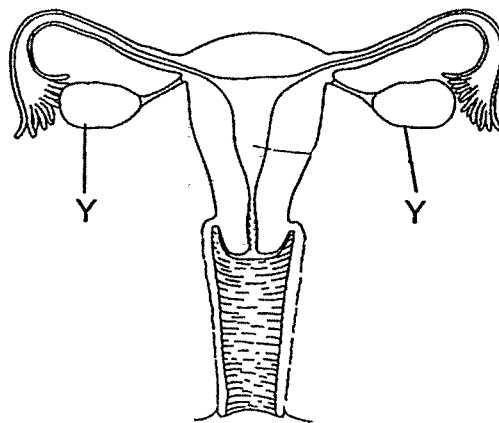

(a) Label with an 'X' in the diagram above to show the part where the fertilised egg develops into a foetus. [1]

(b) During the mating process, thousands of sperms are released into the female reproductive system. Explain how this helps in the process of fertilisation. [1]

(c) Would it be possible for fertilisation to take place if both parts Y were removed? Explain your answer. [1]

Score	3
-------	---

27. The diagram shows two flowers, A and B, with both male and female reproductive parts.

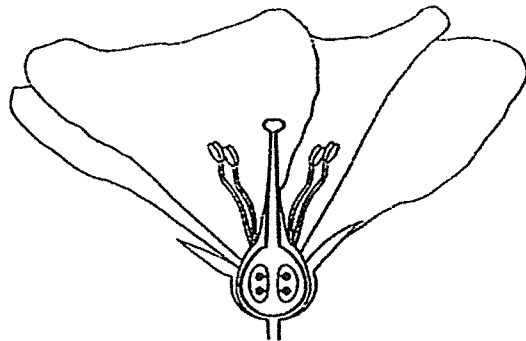

Flower A

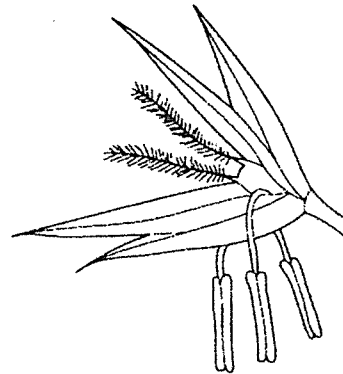

Flower B

- (a) Based on the observations of the flowers,
 (i) state how each flower is pollinated in the table below. [1]

Flower	Method of pollination
A	_____
B	_____

- (ii) state one difference between the physical characteristics of the two flowers above. [1]

- (b) Name the process that occurs after pollination has taken place. [1]

Score	3
-------	---

28. Peter wanted to investigate if the plants absorb water through the roots. He prepared a set-up as shown below.

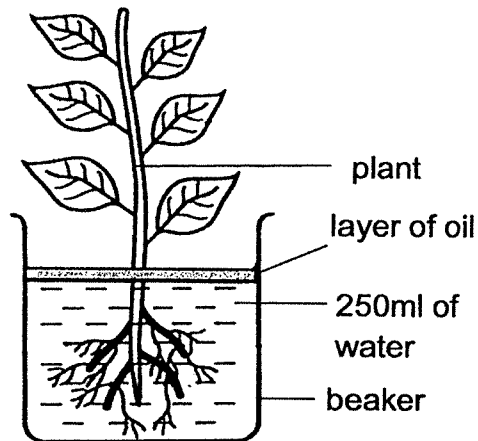

experimental set-up

- (a) What is the purpose of the layer of oil in this experiment? [1]

- (b) Next, Peter prepared a control set-up as shown below. His friend commented that his set-up was wrong.

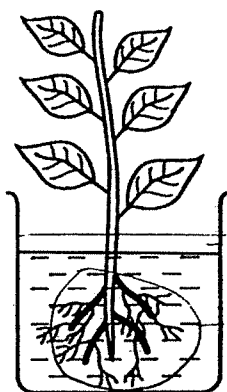

control set-up

Without removing any parts of the plant in the control set-up, suggest **two** changes that must be made to the control set-up to ensure a fair test. [2]

(i) _____

(ii) _____

Score	3
-------	---

29. The graph below shows the average amount of undigested food leaving three parts of the digestive system.

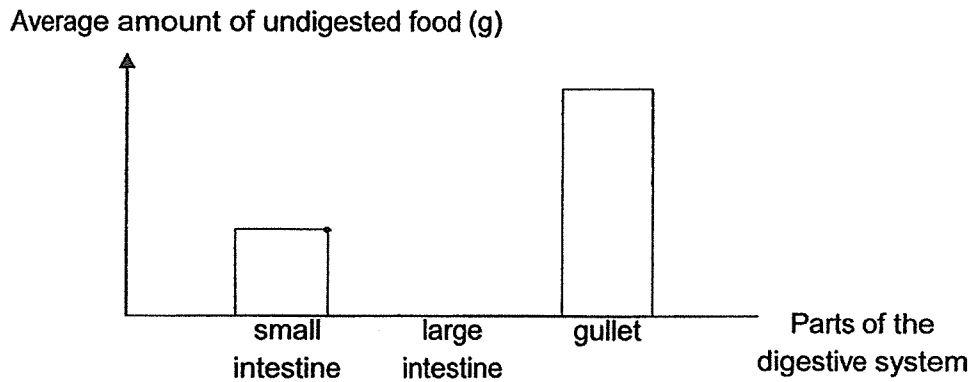

- (a) Complete the graph above by drawing a bar to show the average amount of undigested food in the large intestine. [1]

Two identical type of food samples of equal mass were placed into two similar beakers, X and Y, containing equal amounts of digestive juices. Three hours later, the mass of the undigested food particles in both beakers were measured.

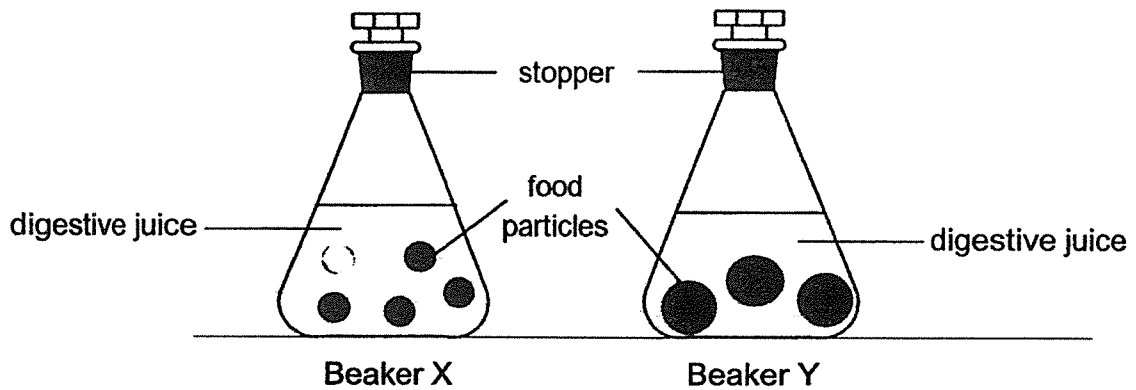

- (b) What would be the difference between the mass of the food samples in both beakers after three hours? Explain your answer. [2]

Score	3
-------	---

30. The diagram below shows cell A.

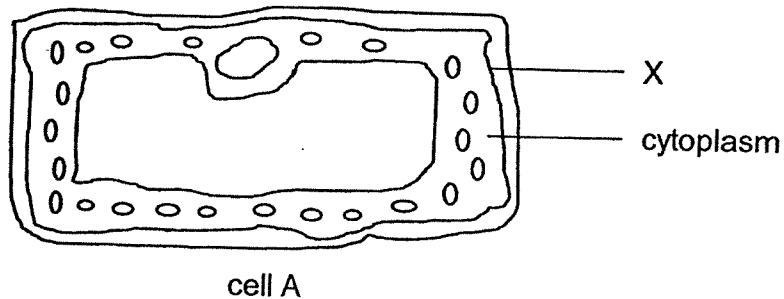

(a) Name part X as seen in the above diagram. [1]

(b) When cell A is placed in a dish filled with liquid P, water will move out of the cell causing the cytoplasm to shrink as shown in the diagram below.

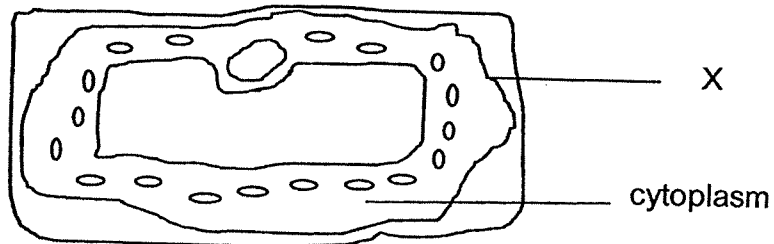

(i) State a characteristic of part X that allows water to move out of the cell. [1]

(ii) Give a reason why cell A was able to maintain its shape even though water moved out of the cell. [1]

Score	3
-------	---

31. The diagram below shows a human respiratory system.

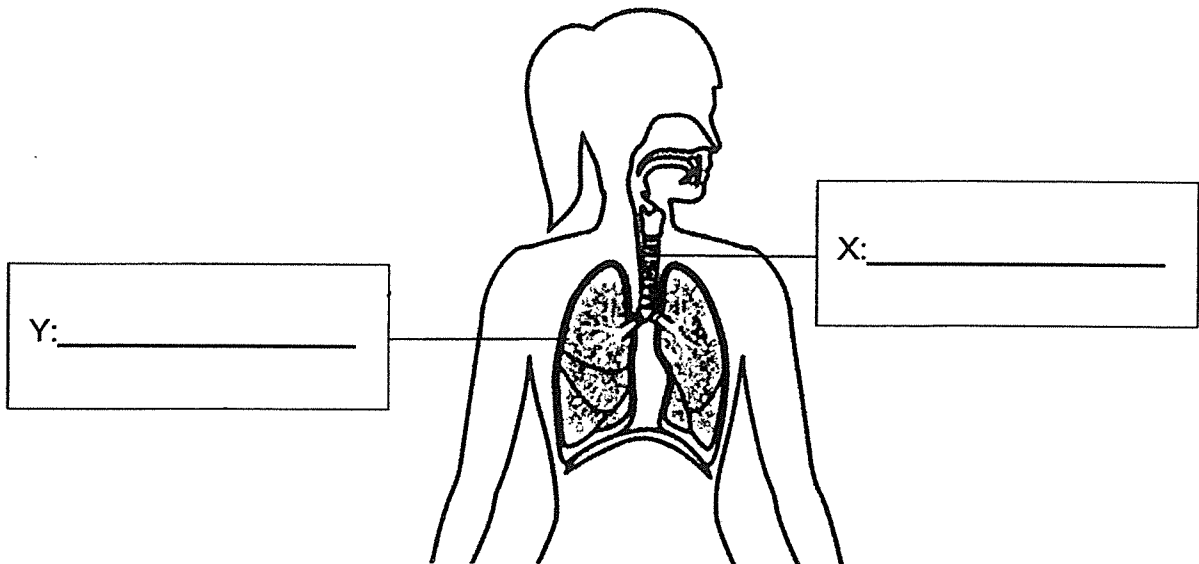

- (a) Name the parts X and Y of the human respiratory system in the diagram above. [1]
- (b) What is the function of part Y? [1]

Score	<hr/>
	2

32. The graph below shows Peter's number of heartbeats per minute during three different activities, X, Y and Z.

Heartbeats per minute

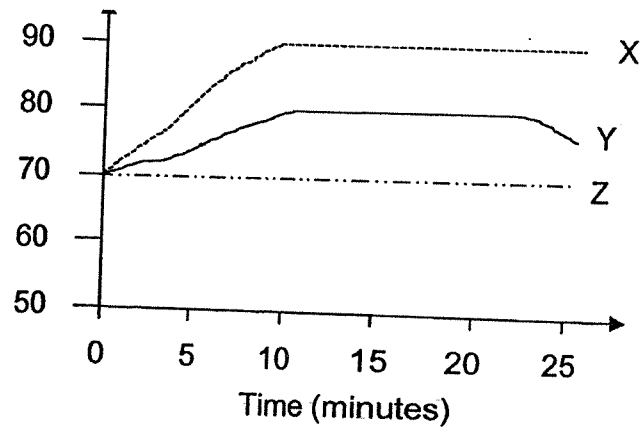

Based on the information in the graph above, answer the following questions:

- (a) Which activity, X, Y or Z, shows that Peter was resting? [1]

- (b) Which activity, X, Y or Z, was the most vigorous activity that Peter was engaged in? Give a reason for your answer. [2]

Score	3
-------	---

33. The diagram below shows a plant in a beaker of water.

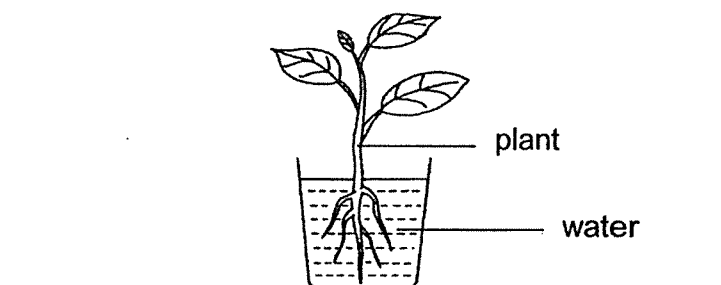

- (a) Label and name the part of the plant that helps to take in carbon dioxide and gives out oxygen in the diagram above. [1]
- (b) The plant was placed on a rotating disc and was kept in a black box with a hole at the side as shown in the diagram below. The plant rotates one complete round every hour. The black box was placed with the hole facing a window.

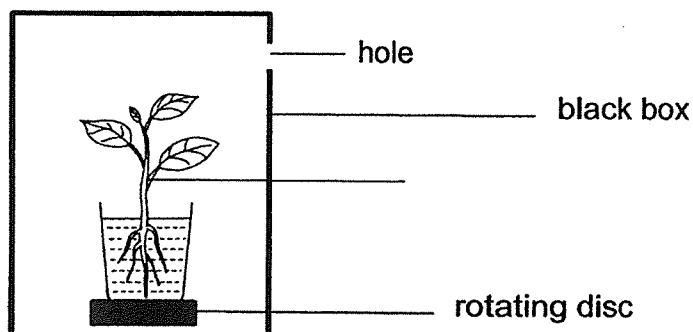

Place a tick (✓) in the box that shows what the plant would look like after one week. [1]

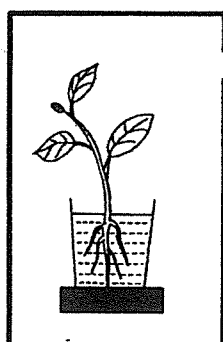

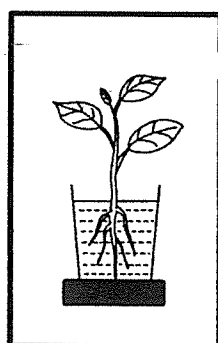

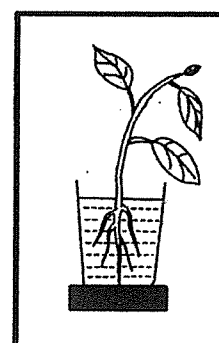

Score	2
-------	---

34. Kate placed a leaf from plant A in a container of hot water as shown in the diagram below.

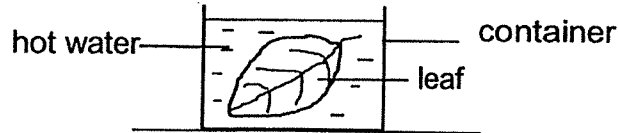

- (a) Kate noticed that there were more bubbles on the lower surface of the leaf than on the upper surface. Give a reason for your answer. [1]

- (b) Kate prepared three identical plants P, Q and R. She coated some surfaces of the leaves of plants, P, Q and R, with oil as shown in the table below.

Plant	Coated with oil	
	Upper surface	Lower surface
P	no	yes
Q	yes	no
R	no	no

She then placed plants P, Q and R, in identical containers of water as shown below.

The plant gives out water vapour through their stomata on the leaves.

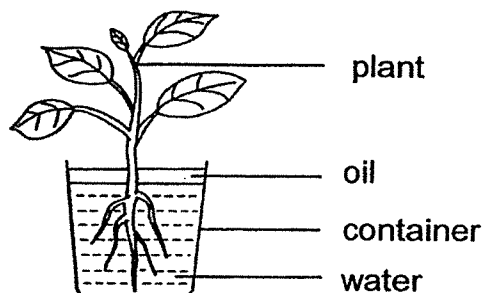

Continue in the next page

Score	1
-------	---

Continued from previous page

The set-ups were placed under bright sunlight for two hours. Kate measured the volume of water left in the beaker at regular intervals and recorded the results in the graph below.

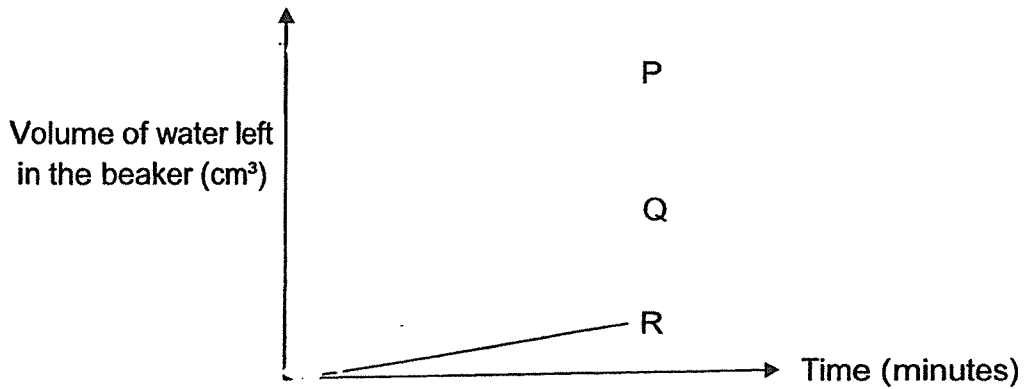

Based on the information in (a) and (b), which plant lost the least amount of water? Explain your answer. [2]

Score	2
-------	---

35. Peter claimed that he observed some steam while having a hot shower.

(a) What is wrong about Peter's claim in observing steam in the shower? [1]

(b) Without drying himself, he stepped out of the bathroom with his wet body. After some time, he felt cool. Explain why he felt cool after some time. [2]

(c) Peter felt cooler when he stepped into the windy balcony with his wet body. Explain why. [1]

Score	4
-------	---

36. Ben set up an experimental set-up as shown below.

Two identical bottles were used, one was filled with air, while the other filled with sand. Both of the bottles were sealed with a rubber stopper. He then placed the bottles on top of identical hot plates with the same temperature.

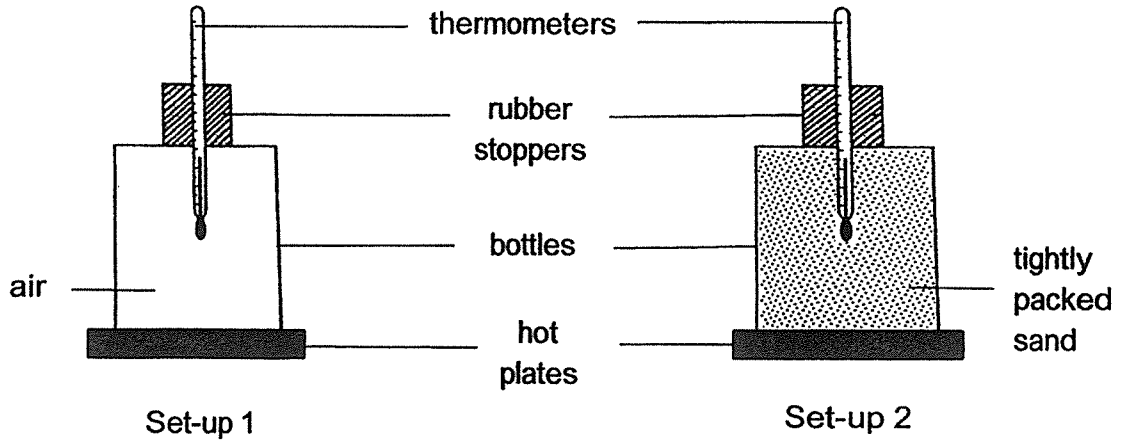

After ten minutes, he recorded the temperature in the bottles as shown in the table below.

	Temperature of substances in the bottle (°C)	
	At the start	After 10 minutes
Set-up 1	30	32
Set-up 2	30	40

(a) What can Ben conclude about how the temperature of the substance in the bottle changes with time in set-up 1 as compared to set-up 2? Explain your answer. [2]

Continue in the next page

Score	2
-------	---

Continued from previous page

Ben's uncle owns a shop that sells and deliver live fish to his customers. In order to ensure that his fish do not die during the transportation, his uncle has to ensure that the temperature of water in the bag which the fish are kept is maintained at 25°C.

The surrounding air temperature is 35°C.

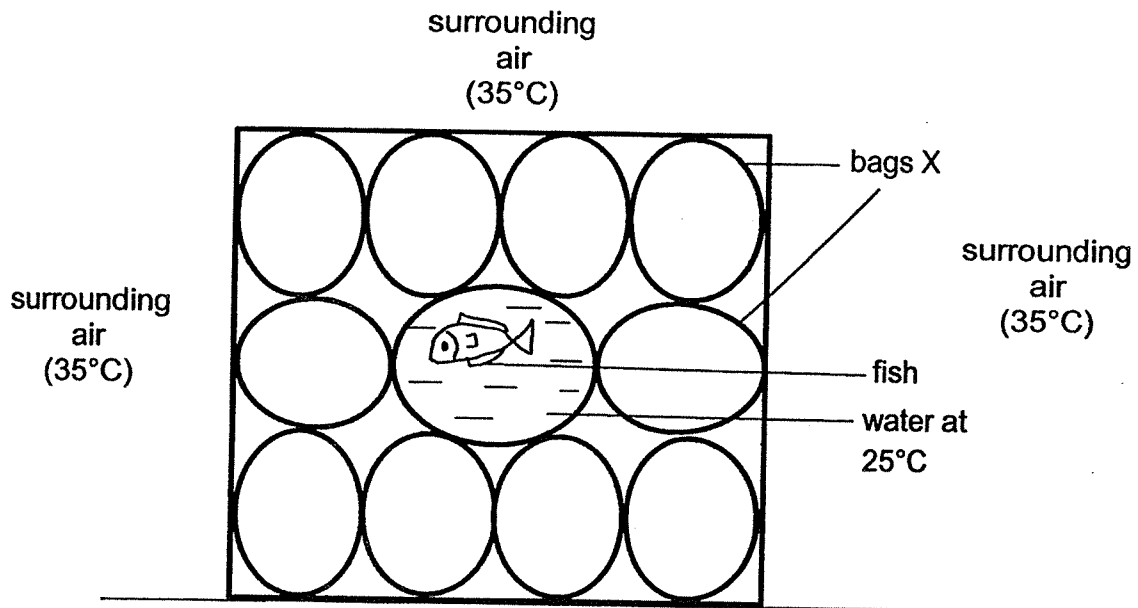

- (b) Based on the information provided, which substance, sand or air, should be used to fill bags X? Explain your answer. [2]

Score	2
-------	---

37. Bob conducted an experiment to test a circuit card using a circuit tester and recorded his observations in the table below.

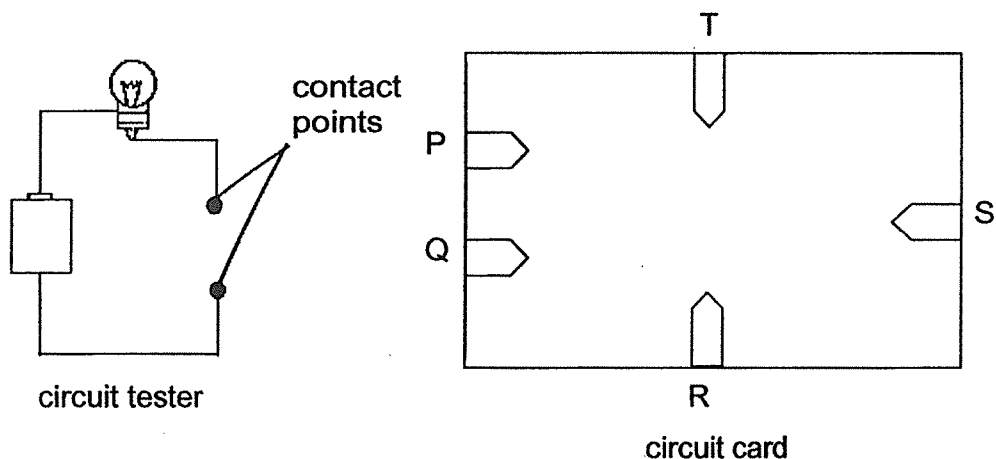

Clips connected to paper clips on circuit tester	Did the bulb of circuit tester light up?
P and Q	Yes
P and R	No
R and S	No
P and T	Yes
Q and T	Yes
P and S	No

- (a) Based on the information above, draw **two lines** in the diagram below to show how the wires were connected in the circuit tester. [1]

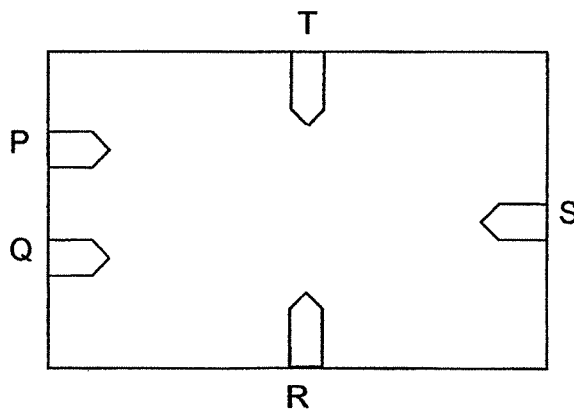

Continue in the next page

Score	1
-------	---

Continued from previous page

The diagram below shows three circuits with different arrangements of identical batteries and bulbs. The bulbs in all three circuits light up. All the bulbs and batteries are all working properly.

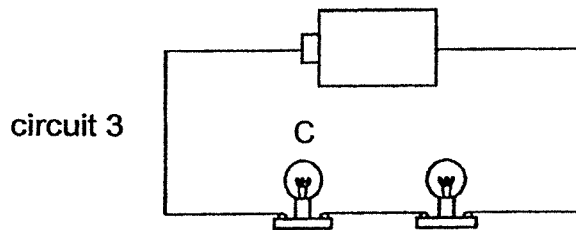
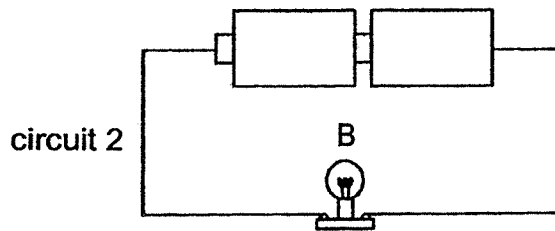
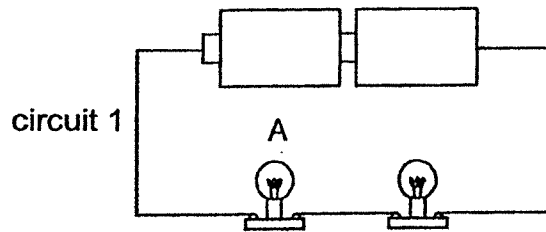

- (b) Arrange the bulbs, A, B and C, starting from the increasing order of brightness. [1]

(least bright) (brightest)

- (c) State two ways to increase the brightness of bulb C without changing the number of batteries. [2]

(i) _____

(ii) _____

Score	3
-------	---

38. The diagram below shows a magnetic sorter. The magnetic sorter would involve the use of four magnets attached to the side of a ramp.

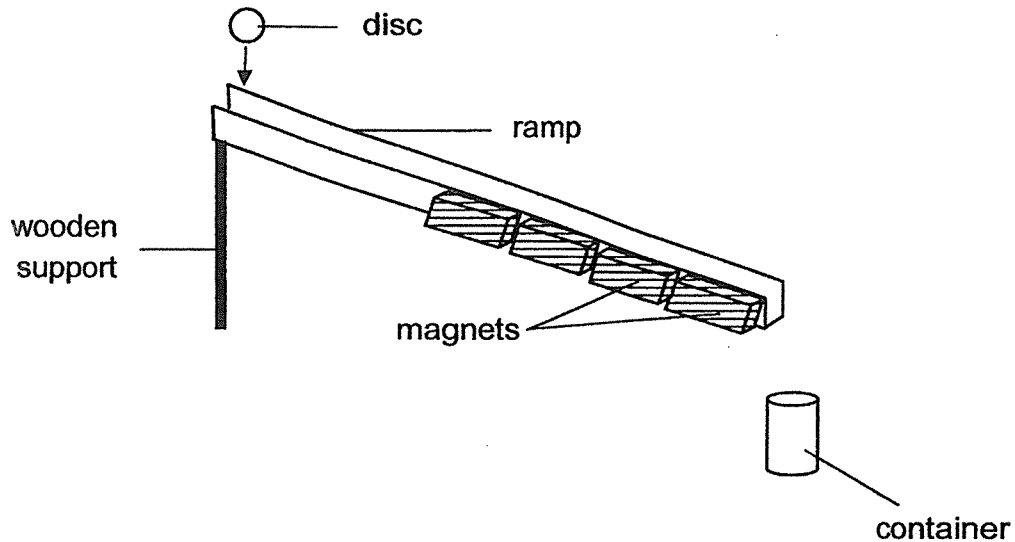

Peter rolled circular disc X down the ramp. He repeated the experiment with another disc Y of the same size and mass and recorded his observations in the table below.

Disc	Roll down the ramp ...
X	slower
Y	faster

Based on the information in the table above, answer the following questions.

- (a) Explain why disc X would roll down the ramp slower than disc Y? [2]

- (b) If Peter rolled an aluminium disc down the ramp, would it roll down the ramp faster than disc X? Give a reason for your answer. [1]

ANSWER KEY

YEAR : 2021
LEVEL : Primary 5
SCHOOL : Raffles Girls' School
SUBJECT : SCIENCE
TERM : Practice Paper 4

BOOKLET A

Q1	4	Q2	1	Q3	1	Q4	1	Q5	2
Q6	1	Q7	4	Q8	1	Q9	3	Q10	1
Q11	4	Q12	1	Q13	2	Q14	1	Q15	2
Q16	3	Q17	3	Q18	3	Q19	4	Q20	4
Q21	1	Q22	4	Q23	4	Q24	4	Q25	4

BOOKLET B

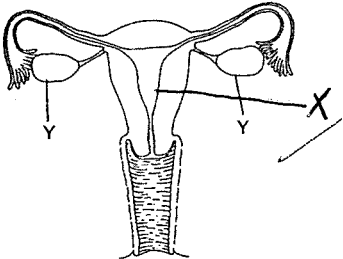
Q26	 <p>(a)</p> <p>(b) This is to increase the chances of at least one of the sperms fertilise the egg.</p> <p>(c) No. Without part Y, no eggs could be produced to be fertilised.</p>					
Q27	<p>(a) (i)</p> <table border="1" style="width: 100%;"> <tr> <td style="width: 50%; text-align: center;">A</td> <td style="text-align: center;">Animal pollination</td> </tr> <tr> <td style="text-align: center;">B</td> <td style="text-align: center;">Wind pollination</td> </tr> </table> <p>(ii) The anthers of flower B are outside the flower while the anthers of flower A are within the flower.</p> <p>(b) fertilisation</p>		A	Animal pollination	B	Wind pollination
A	Animal pollination					
B	Wind pollination					
Q28	<p>(a) To prevent the water in the beaker from evaporating.</p> <p>(b) (i) add a layer of oil</p> <p style="padding-left: 20px;">(ii) Wrap a plastic bag around the roots</p>					

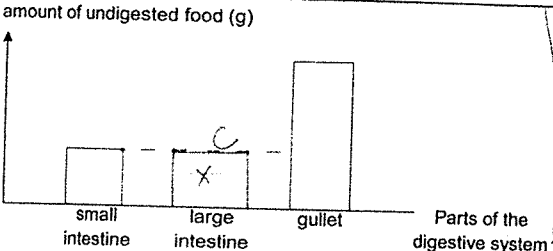
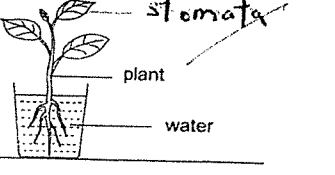
<p>Q29</p>	<p>Average amount of undigested food (g)</p>  <p>(a)</p> <p>(b) The mass of food particles in beaker X is less than that in beaker Y. The food particles in beaker X is smaller. The food particles in beaker X has a larger contact surface area for the digestive juices to act on than in Y. Therefore the rate of digestion is faster in the food samples in beaker Y.</p>
<p>Q30</p>	<p>(a) cell membrane</p> <p>(b) (i) The cell membrane is semi-permeable. (ii) It has a cell wall.</p>
<p>Q31</p>	<p>(a) Y: lungs X: windpipe</p> <p>(b) It helps to absorb oxygen into the blood stream and removes carbon dioxide from the blood stream, gaseous exchange take place in part Y.</p>
<p>Q32</p>	<p>(a) Z</p> <p>(b) X. His heart rate was the highest when he was carrying out activit X. the heart beat faster to transport most amount of oxygen to all parts of the body to release the most energy.</p>
<p>Q33</p>	 <p>(a)</p> <p>Place a tick (✓) in the box that shows what the plant would look like after one week. [1]</p> <p>(b) <input type="checkbox"/> <input checked="" type="checkbox"/> <input type="checkbox"/></p>
<p>Q34</p>	<p>(a) There are more stomata on the underside of the leaf.</p> <p>(b) Plant P. The amount of water left in the beaker with plant P is the most thus plant P lost the most amount of water. Most of its stomata are found on the lower side of the leaf which is coated by a layer of oil thus reducing the amount of water loss.</p>
<p>Q35</p>	<p>(a) Steam is invisible. What Peter observed is actually tiny water droplets.</p> <p>(b) Water on his body gained heat from his body and evaporated into water vapour. This removed heat from his body thus he felt cool.</p> <p>(c) The wind increased the rate of evaporation of water on his body thus removing more heat from his body.</p>
<p>Q36</p>	<p>(a) The temperature of substance in the bottle in set-up 1 has a smaller increase in teperature as air is a poorer heat conductor thus it gained heat from the hot plate more slowly.</p>

	<p>(b) Air. Air is a poor conductor of heat. Water containing the fish will gain heat from the warmer surrounding air more slowly ensuring the temperature of water is kept at 25°C.</p>
<p>Q37</p>	<div data-bbox="311 347 662 593" data-label="Diagram"> </div> <p>(a) (b) C, A, B (c) (i) Use a battery with a higher voltage instead (ii) Take out a bulb</p>
<p>Q38</p>	<p>(a) Disc X is made of a magnetic material, and is attracted to the magnets as it rolls down. Thus it rolls down the ramp slower. (b) Yes. Aluminium is a non-magnetic material therefore it will not be attracted to the magnets.</p>

3
END