



RED SWASTIKA SCHOOL

2021 SEMESTRAL ASSESSMENT

MATHEMATICS PAPER 1

Name : _____ ()

Class : Primary 5 / _____

Date : 29 Oct 2021

BOOKLET A

14 Questions

18 Marks

Duration of Paper 1 (Booklets A & B): 1 hour

Note:

1. Do not open this Booklet until you are told to do so.
2. Read carefully the instructions given at the beginning of each part of the Booklet.
3. Do not waste time. If a question is difficult for you, go on to the next one.
4. Check your answers thoroughly and make sure you attempt every question.
5. In this booklet, you should have the following:
 - (a) Page 1 to Page 5
 - (b) Questions 1 to 14
6. You are not allowed to use a calculator.

Questions 1 to 10 carry 1 mark each. Questions 11 to 14 carry 2 marks each. For each question, four options are given. One of them is the correct answer. Make your choice (1, 2, 3 or 4). Shade the correct oval (1, 2, 3 or 4) on the Optical Answer Sheet. (18 marks)

1 Which of the following is fifty-eight thousand and eleven in numerals?

- (1) 5811
- (2) 58 011
- (3) 58 110
- (4) 580 011

2 In the number line, what is the mixed number represented by letter A?

- (1) $3\frac{1}{2}$
- (2) $3\frac{3}{4}$
- (3) $3\frac{2}{5}$
- (4) $3\frac{4}{5}$

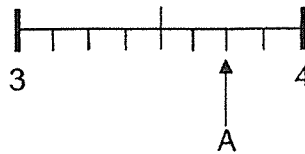

3 Find the value of $0.28 \div 10$.

- (1) 28
- (2) 2.8
- (3) 0.028
- (4) 0.0028

4 What is 1.09 litres in millilitres?

- (1) 109 ml
- (2) 1009 ml
- (3) 1090 ml
- (4) 1900 ml

5 Xinyi is 1.62 m tall. She is 8 cm shorter than her brother. What is her brother's height in metres?

- (1) 1.54 m
- (2) 1.70 m
- (3) 6.38 m
- (4) 9.62 m

6 In the square grid below, X is a rectangle, Y is an isosceles triangle and Z is a right-angled triangle. Arrange X, Y and Z from the smallest area to the greatest area.

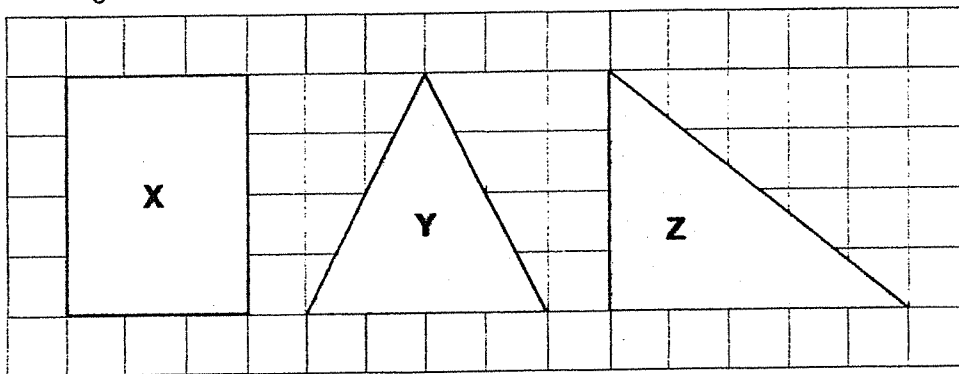

Smallest

Greatest

- | | | | |
|-----|----|----|---|
| (1) | Y, | X, | Z |
| (2) | X, | Y, | Z |
| (3) | Z, | Y, | X |
| (4) | Y, | Z, | X |

7 The side of the cube is 7 cm. What is the volume of the cube?

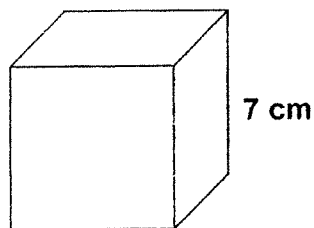

- (1) 21 cm³
- (2) 49 cm³
- (3) 294 cm³
- (4) 343 cm³

- 8 In the figure below, AB and CD are straight lines. Which one of the following statements is true?

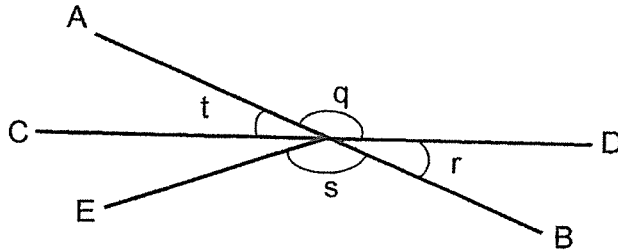

- (1) $\angle q = \angle s$
(2) $\angle t = \angle r$
(3) $\angle s + \angle r = 180^\circ$
(4) $\angle t + \angle r = 180^\circ$
- 9 In a class of 38 students, 16 of them are boys. Find the ratio of the number of girls to the total number of students.
- (1) 16 : 22
(2) 16 : 38
(3) 22 : 16
(4) 22 : 38
- 10 Zi Wei had \$120. He spent \$84 on a pair of sports shoes and saved the rest. What percentage of his money did he spend?
- (1) 16%
(2) 30%
(3) 70%
(4) 84%

- 11 The figure below is made up of a rectangle and a triangle. The breadth of the rectangle is 5 cm and the length of the rectangle is 10 cm. Find the area of the figure.

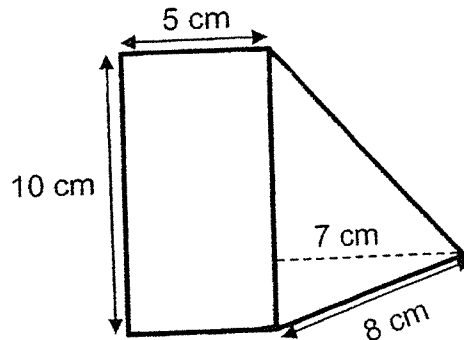

- (1) 85 cm²
- (2) 92 cm²
- (3) 120 cm²
- (4) 130 cm²

- 12 The first 16 numbers of a number pattern are given below. What is the sum of the first 48 numbers?

4, 0, 1, 1, 4, 4, 0, 1, 1, 4, 4, 0, 1, 1, 4, 4,.....

1st 16th

- (1) 124
 - (2) 102
 - (3) 95
 - (4) 30
- 13 Dorothy was given \$3 pocket money every day of the week. She spent \$2.30 each day from Monday to Friday and saved the rest. She saved 50 cents more each day on Saturday and Sunday than on Monday to Friday. How much did Dorothy save in a week?
- (1) \$5.90
 - (2) \$5.40
 - (3) \$4.90
 - (4) \$4.50

14 Which of the dotted lines below is a line of symmetry of this figure?

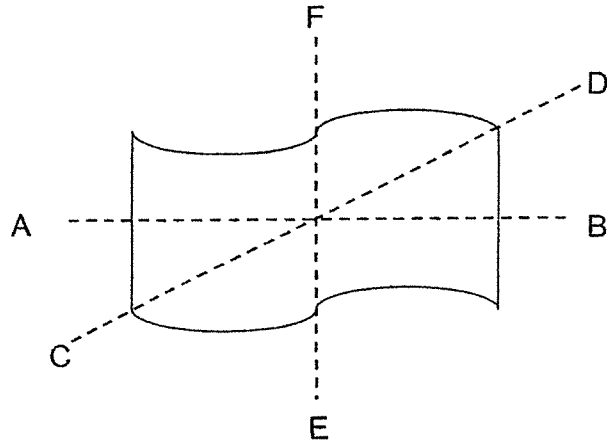

- (1) AB
- (2) CD
- (3) EF
- (4) None of the above



RED SWASTIKA SCHOOL

2021 SEMESTRAL ASSESSMENT

MATHEMATICS PAPER 1

Name : _____ ()

Class : Primary 5 / _____

Date : 29 Oct 2021

BOOKLET B

15 Questions
25 Marks

In this booklet, you should have the following:

- (a) Page 6 to Page 12
- (b) Questions 15 to 29

MARKS

	OBTAINED	POSSIBLE
BOOKLET A		18
BOOKLET B		25
TOTAL		43

Parent's Signature : _____

Questions 15 to 19 carry 1 mark each. Write your answers in the spaces provided. For questions which require units, give your answers in the units stated. (5 marks)

15 Find the value of $18 \div 6 - 2 + 4 \times 5$.

Ans: _____

16 Mufee made 100 tarts. For every 25 tarts, he used 6 cups of sugar. How many cups of sugar did he use altogether?

Ans: _____

17 By joining dots on the grid with straight lines, complete the drawing of the cuboid.

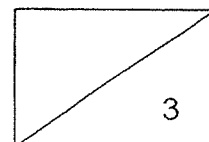
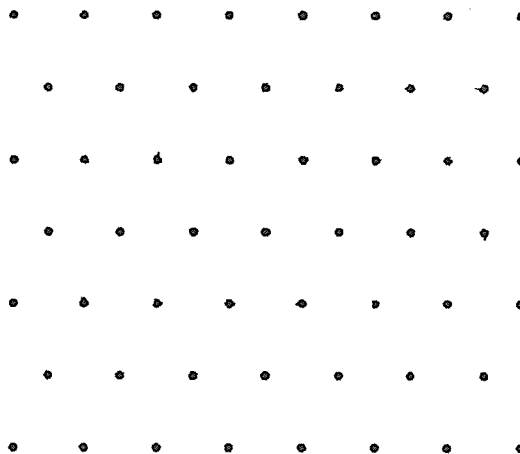

- 18 Tomatoes are sold at 50 cents per 100 g in the market. What is the price of 500 g of tomatoes?

Ans: \$ _____

- 19 How many pair/s of parallel lines and perpendicular lines is/are in the letter shown below?



Ans: Parallel lines : _____ pair/s

Perpendicular lines: _____ pair/s

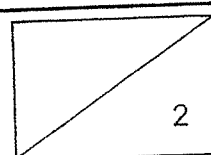

Questions 20 to 29 carry 2 marks each. Show your workings clearly in the space provided for each question and write your answers in the spaces provided. For questions which require units, give your answers in the units stated.

(20 marks)

-
- 20 Jonas read a book over 2 days. On the first day, he read $\frac{1}{2}$ of the book and 2 additional pages. On the second day, he read the remaining 20 pages. How many pages did he read on the first day?

Ans: _____

-
- 21 Find the value of 0.37×800

Ans: _____

8

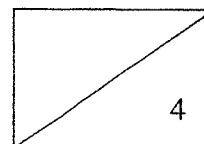

- 22 Tommy jogged 9.6 km. Kate jogged 120 m less than Tommy. What was the distance Kate jogged? Give your answer in km and m.

Ans: _____ km _____ m

- 23 The figure shows a rectangular glass box partly filled with unit cubes. How many cubes are there in the glass box?

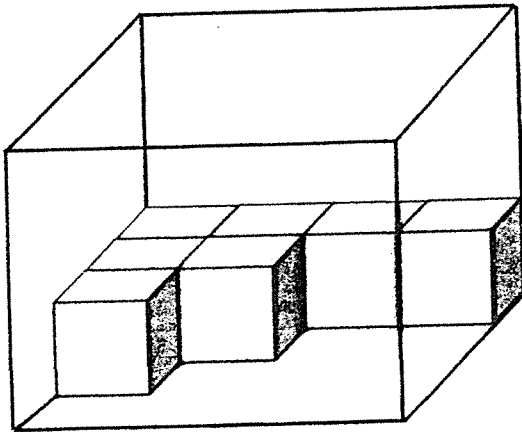

Ans: _____

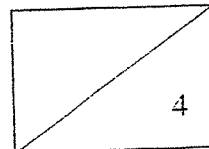

- 24 Zhiming used a calculator to divide a 4-digit number by a 1-digit number. For the 1-digit number, he made a mistake by pressing 6 instead of 5. He obtained the incorrect answer of 560. What should be the correct answer?

Ans: _____

- 25 Kuneé pasted a rectangular piece of paper on a square piece of paper. She folded it along the dotted line as shown below. AB is a straight line. Find $\angle x$.

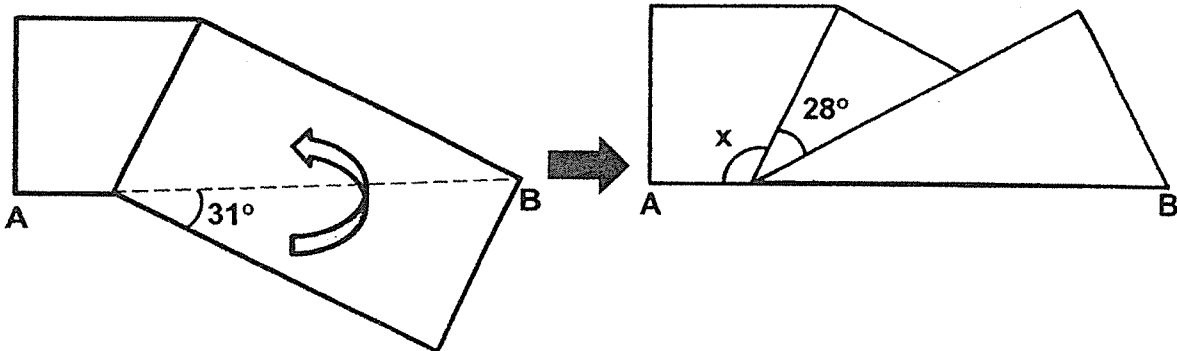

Ans: _____

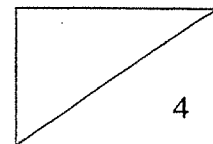

- 26 A rope was cut into two pieces in the ratio of 5 : 8. The longer piece was 30 cm in length more than the shorter piece. What was the length of the shorter piece?

Ans: _____ cm

- 27 Pamela had some English and Chinese storybooks. She sold $\frac{1}{3}$ of her English storybooks and $\frac{4}{9}$ of her Chinese storybooks. $\frac{7}{11}$ of the books sold were English books. What fraction of the books did Pamela sell?

Ans: _____

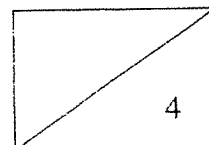

- 28 Dan and Terry were at a bus-stop waiting for their buses. Dan's bus was scheduled to arrive at 1.45 pm but it arrived .15 minutes late. Terry's bus was scheduled to arrive at 1435 but it came 20 minutes early. What was the difference in duration between the arrival time of both buses?

Ans: _____ min

- 29 Mrs Tng poured the water from Containers A and B into a glass tank with a square base of length 20 cm and height of 15 cm. How much more water must be added to fill up the glass tank to its brim? Leave your answer in litres.

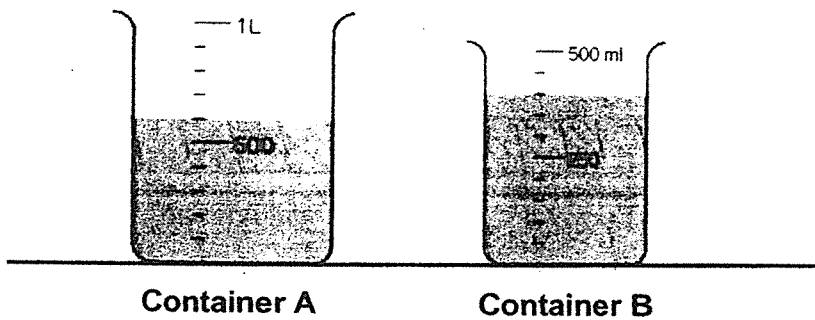

Ans: _____ l

END OF PAPER

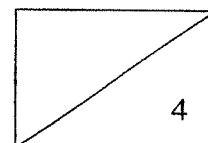



RED SWASTIKA SCHOOL
2021 SEMESTRAL ASSESSMENT
MATHEMATICS
PAPER 2

Name : _____ ()

Class : Primary 5 / _____

Date : 29 Oct 2021

14 Questions

47 Marks

Duration of Paper 2: 1 hour 30 minutes

Note:

1. Do not open this Booklet until you are told to do so.
2. Read carefully the instructions given at the beginning of each part of the Booklet.
3. Do not waste time. If a question is difficult for you, go on to the next one.
4. Check your answers thoroughly and make sure you attempt every question.
5. In this paper, you should have the following:
 - (a) Page 1 to Page 11
 - (b) Questions 1 to 14
6. You are allowed to use a calculator.

MARKS

	OBTAINED	POSSIBLE
PAPER 1		43
PAPER 2		47
TOTAL		90

Parent's Signature : _____

Questions 1 to 4 carry 2 marks each. Show your workings clearly in the space below each question and write your answers in the spaces provided. For questions which require units, give your answers in the units stated.

(8 marks)

- 1 Alice scored 70 marks and Mei Li scored 89 marks during their term test. What was their average score?

Ans: _____

- 2 In the figure, PQR and PXR are right-angled triangles.
(a) Measure the base of triangle PQX if its height is PX.
(b) Measure the height of triangle PQR if its base is PR.

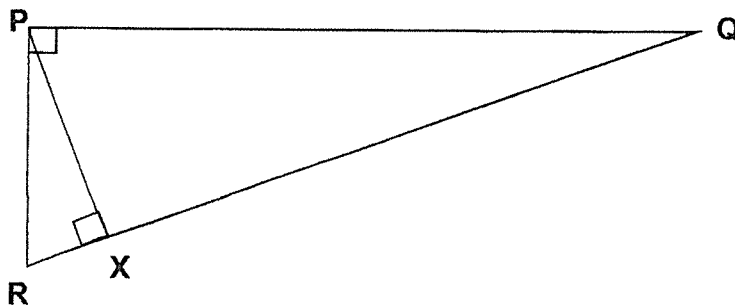

Ans: (a) Base : _____ cm

(b) Height: _____ cm

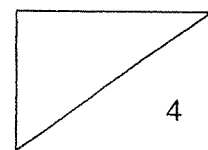

- 3 In the figure below, find $\angle s$.

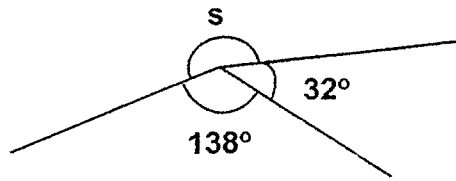

Ans: _____^o

- 4 The table below shows the airmail rates for sending letters and postcards to some countries.

Destination	Letters		Postcards
	Mass	Postage Rate	per piece
Australia, Japan, New Zealand	1 st 20 g	\$1.40	\$0.60
	Every additional 10 g or part thereof	\$0.35	

How much did Susan pay for the postage when she sent a letter which weighed 46 g and 2 postcards to Japan by airmail?

Ans: \$ _____

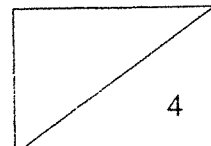

For Questions 5 to 14, show your workings clearly in the space below each question and write your answers in the spaces provided. The number of marks available is shown in brackets [] at the end of each question or part-question.

(39 marks)

-
- 5 A shop gave a discount of \$5 for every \$20 spent. Mrs Tay bought a dress and paid \$100 after the discount. What was the price of the dress before the discount?

Ans: _____ [3]

-
- 6 Mr Ma had some calculators for sale. After selling 12 of them on Monday and $\frac{5}{8}$ of the remainder on Tuesday, he was left with 24 calculators. How many calculators did he have at first?

Ans: _____ [3]

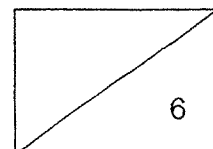

- 7 Worker A and Worker B are asked to give out the same number of leaflets. Worker A can give out the leaflets in 8 hours while Worker B can give out the leaflets in 5 hours. Both workers started giving out the leaflets at the same time for 4 hours. After 4 hours, Worker A gave out 180 leaflets. How many leaflets can Worker B give out in 4 hours?

Ans: _____ [3]

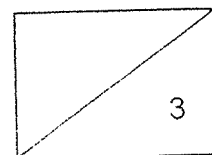

- 8 Highlighters of four different colours are sold in Bookshop A and B. The bar graphs show the number of highlighters sold by each bookshop.

The bar for the number of purple highlighters sold by Bookshop B has not been drawn.

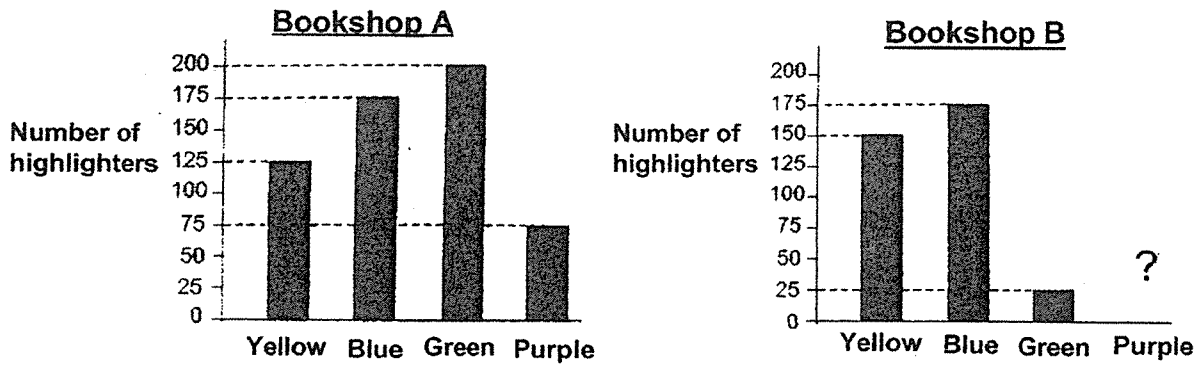

- (a) How many highlighters did Bookshop A sell?
- (b) The number of purple highlighters sold by Bookshop B was $\frac{1}{3}$ of the number of purple highlighters sold by Bookshop A. How many purple highlighters did Bookshop B sell?
- (c) Which colour(s) of highlighters did Bookshop B sell more than Bookshop A?

Ans: (a) _____ [1]
 (b) _____ [1]
 (c) _____ [1]

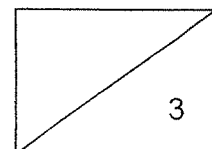

- 9 A total of 900 apples and 400 oranges were given away at a health exhibition over two days. 24% of the fruits were given out on Day 1 and the rest were given out on Day 2. How many fruits were given out on Day 1?

Ans: _____ [4]

6

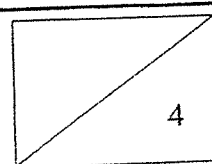

- 10 Ali has some money. He could either buy 9 identical files or 14 identical pens. Each file cost \$2.75 more than each pen. How much do 9 such files cost?

Ans: _____ [5]

7

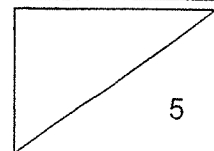

- 11 The average mass of a class of 39 students is 48 kg. If the mass of the teacher is to be included, the average mass increases by 500 g. What is the actual mass of the teacher? Give your answer in kilograms.

Ans: _____ [5]

8

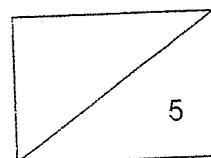

- 12 Ali and Seth had a total of 243 marbles. Bala had three times as many marbles as Ali. Given that Seth and Ali had marbles in the ratio 5 : 4, how many marbles did Bala have?

Ans: _____ [4]

9

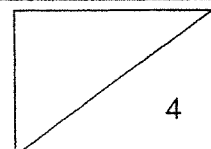

- 13 Ismail's shop sells shoes and T-shirts. A pair of shoes is sold at \$52 and a T-shirt is sold at $\frac{3}{4}$ of the price of a pair of shoes. On Sunday, Ismail sold $\frac{5}{6}$ of the items in his shop and collected \$3978. $\frac{2}{5}$ of the items sold were shoes. How many items were unsold after Sunday?

Ans: _____ [4]

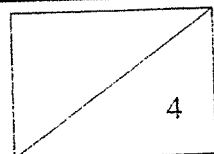

14. The first three figures of a pattern are shown below. Answer the following questions.



Figure 1

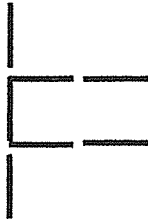

Figure 2

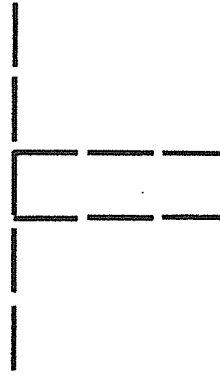

Figure 3

Figure	Number of sticks
1	3
2	7
3	11
4	?

- (a) How many sticks are there in Figure 4?
- (b) How many sticks are there in Figure 30?
- (c) Which figure contains 287 sticks?

Ans: (a) _____ [1]

(b) _____ [2]

(c) _____ [2]

END OF PAPER

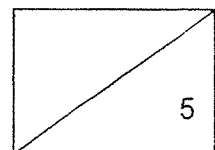

ANSWER KEY

YEAR : 2021
LEVEL : Primary 5
SCHOOL : Red Swastika School
SUBJECT : MATHEMATICS
TERM : Semestral Assessment

BOOKLET A (PAPER 1)

Q1	2	Q2	2	Q3	3	Q4	3	Q5	2
Q6	4	Q7	4	Q8	2	Q9	4	Q10	3
Q11	1	Q12	3	Q13	1	Q14	4		

BOOKLET B (PAPER 1)

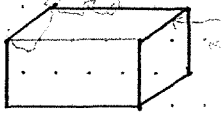
Q15	21	Q16	$6 \times 4 = 24$
Q17		Q18	$0.50 \times 5 = \$2.50$
Q19	Parallel lines : 2 Perpendicular line : 4	Q20	$20+2=22$ $22+2=24$
Q21	296	Q22	$9.6-0.12=9.48$ Ans : 9km 480m
Q23	7	Q24	$560 \times 6 = 3360$ $3360 \div 5 = 672$
Q25	$180-28-31=121$	Q26	$(30 \div 3) \times 5 = 50$
Q27	$\frac{4}{30} + \frac{7}{30} = \frac{11}{30}$	Q28	Dan 2.00pm Terry 2.15pm Ans : 15min
Q29	$20 \times 20 \times 15 = 6000$ $600+400=1000$ $6000-1000=5000$ $5000\text{ml} = 5\ell$		

PAPER 2

Q1	$70+89=159$ $159 \div 2 = 79.5$	Q2	(a) 8.5 (b) 9.1
----	------------------------------------	----	--------------------

Q3	$360-138-32=190$	Q4	$46-20=26$ $0.35 \times 3 = 1.05$ $1.05+1.40=2.45$ $0.60 \times 2 = 1.20$ $1.20+2.45=3.65$
Q5	$100+30=\$130$	Q6	$(24 \div 3) \times 8 = 64$ $64+12=76$
Q7	$180 \times 2 = 360$ $(360 \div 5) \times 4 = 288$	Q8	(a) $125+175+200+75=575$ (b) $75 \div 3 = 25$ (c) Yellow
Q9	$900+400=1300$ $\frac{24}{100} \times 1300 = 312$	Q10	$2.75 \times 9 = 24.75$ $24.75 \div 5 = 4.95$ $4.95+2.75=7.70$ $7.70 \times 9 = \$69.30$
Q11	$48.5 \times 40 = 1940$ $48 \times 39 = 1872$ $1940-1872=68\text{kg}$	Q12	$243 \div 9 = 27$ $27 \times 12 = 324$
Q13	$52 \times 2 = 104$ $39 \times 3 = 117$ $117+104=221$ $3978 \div 221 = 18$ $18 \times 5 = 90$ $90 \div 5 = 18$	Q14	(a) 15 (b) $30 \times 4 - 1 = 119$ (c) $287+1=288$ $288 \div 4 = 72$

2
END