



AI TONG SCHOOL
2021
END-OF-YEAR EXAMINATION
PRIMARY 5

MATHEMATICS
PAPER 1

DURATION : 1 h

DATE : 2 NOVEMBER 2021

INSTRUCTIONS

Do not turn over this page until you are told to do so.

Follow all instructions carefully.

Answer all questions.

Shade your answers in the Optical Answer Sheet (OAS) provided.

The use of calculators is **NOT** allowed.

Name: _____ ()

Class: Primary 5 _____

Marks:

Parent's Signature : _____
Date : _____

Paper 1	45
----------------	-----------

Paper 1 Booklet A

Questions 1 to 10 carry 1 mark each. Questions 11 to 15 carry 2 marks each.
For each question, four options are given. One of them is the correct answer.
Make your choice (1, 2, 3 or 4) and shade your answer on the Optical Answer Sheet.
(20 marks)

1 Write one million, one hundred and nine thousand and eight in numerals.

- (1) 1 009 108
- (2) 1 019 008
- (3) 1 090 108
- (4) 1 109 008

2 Which one of the following fractions is in its simplest form?

- (1) $\frac{3}{18}$
- (2) $\frac{4}{20}$
- (3) $\frac{5}{12}$
- (4) $\frac{6}{15}$

3 How many fifths are there in $12\frac{2}{5}$?

- (1) 19
- (2) 2
- (3) 29
- (4) 62

4 Which of the following could be the height of a classroom door?

- (1) 210 cm
- (2) 210 m
- (3) 21 cm
- (4) 21 m

5 In the number line below, what is the value of Q?

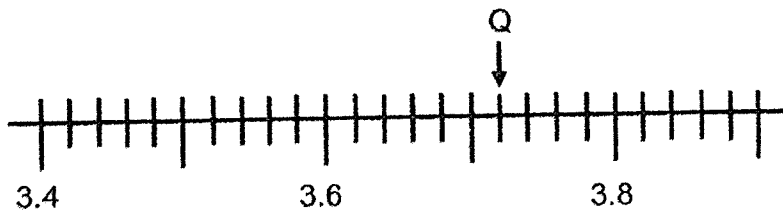

- (1) 3.720
- (2) 3.710
- (3) 3.660
- (4) 3.651

6 What is the ratio of the number of star shapes to the number of heart shapes to the total number of shapes in the box below?

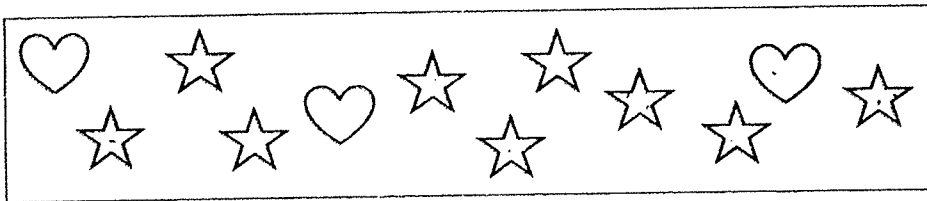

- (1) 9 : 12 : 3
- (2) 3 : 9 : 12
- (3) 4 : 1 : 3
- (4) 3 : 1 : 4

7 What is the missing number in the \square ?

$$7 : \square = 2 : 8$$

- (1) 56
- (2) 28
- (3) 13
- (4) 10

8 Which of the following letters shown below does **not** have any line of symmetry?

(1) **N**

(2) **Y**

(3) **D**

(4) **H**

9 What is the value of $(18 + 12 \div 2) \times 3$?

- (1) 20
- (2) 36
- (3) 45
- (4) 72

- 10 The diagram below shows a road map.

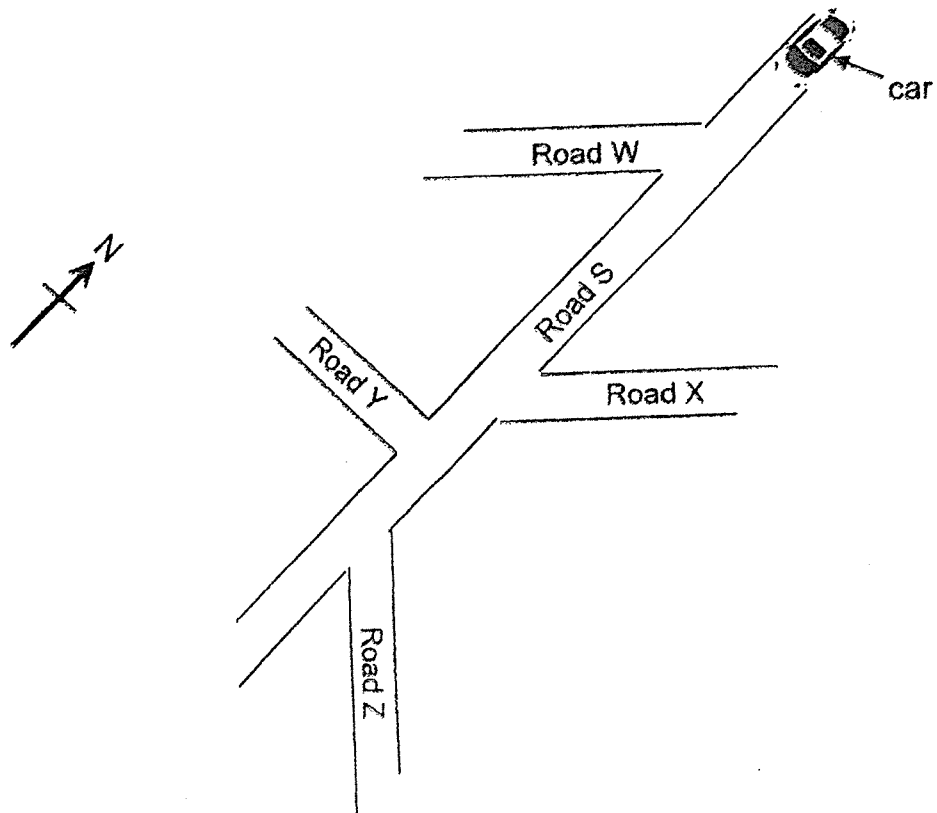

- A car travelled along Road S towards the south. After turning into another road, the car was facing south-east. Which road did it turn into?
- (1) Road W
 - (2) Road X
 - (3) Road Y
 - (4) Road Z
- 11 The average of 7 numbers is 70. One of the numbers is 160. What is the average of the other 6 numbers?
- (1) 330
 - (2) 150
 - (3) 55
 - (4) 15

- 12 Identical rectangular pieces, each measuring 3 cm by 10 cm, were cut out from a square piece of card. Three such rectangular pieces are shown in the figure below. What is the most number of such rectangular pieces that can be cut out from the square piece of card?

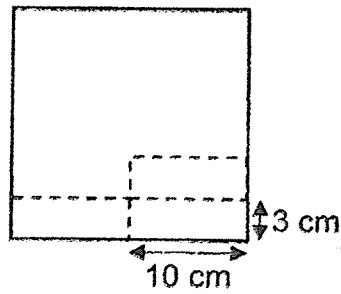

- (1) 6
- (2) 12
- (3) 13
- (4) 14

- 13 In the figure below, a rectangular piece of paper ABCD was folded along AC. $\angle DAC$ is 62° . Find $\angle DCB$.

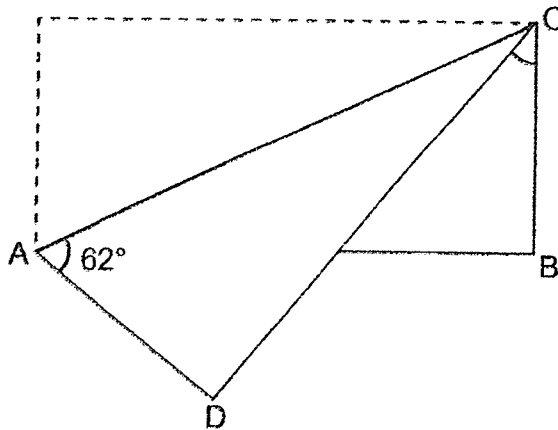

- (1) 62°
- (2) 34°
- (3) 31°
- (4) 28°

- 14 Container R is filled with water to a height of 13 cm at first. Container S is a 9-cm cubical container which is empty at first. After pouring all the water from container R into container S without spilling, how much more water is needed to fill container S to the brim?

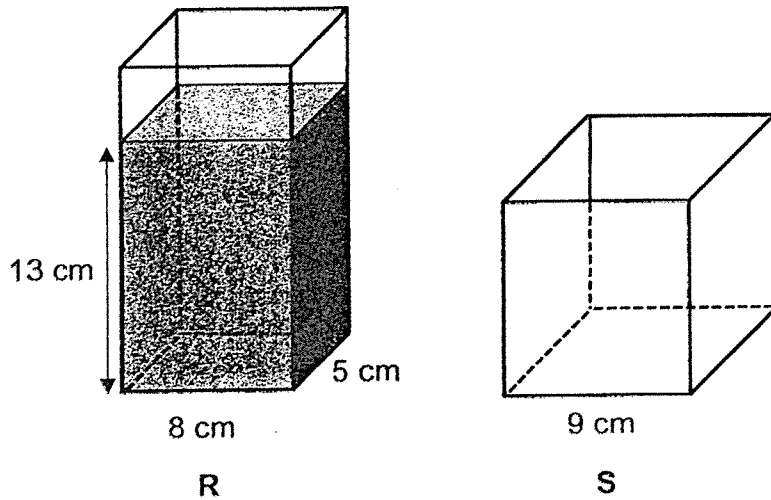

- (1) 209 cm^3
 (2) 439 cm^3
 (3) 520 cm^3
 (4) 729 cm^3

- 15 Points U, V, W, X, Y and Z are points drawn on a pair of parallel lines. Points U, Y and Z have been joined to form Triangle UYZ. Which 3 of the points shown can be joined to form another triangle with the same area as Triangle UYZ?

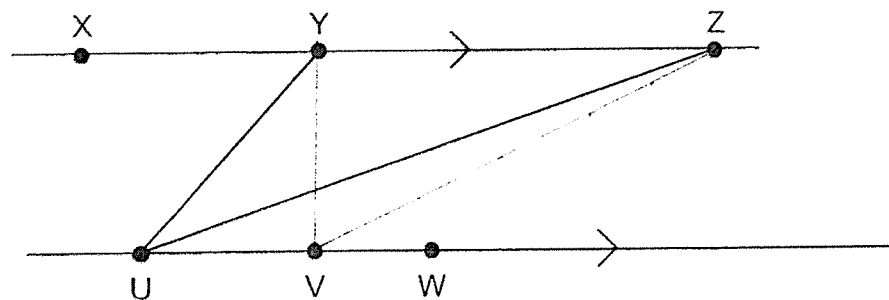

- (1) U, W and Z
 (2) U, X and Z
 (3) V, Y and Z
 (4) X, W and Z

Booklet B

Questions 16 to 20 carry 1 mark each. Write your answers in the spaces provided.
For questions which require units, give your answers in the units stated.

(5 marks)

16 Find the value of $123.6 - 29.02$

Ans: _____

17 5 children shared 4 pizzas equally. What fraction of a pizza did each child get?

Ans _____

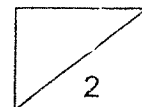

- 18 $\frac{7}{12}$ of the pupils in a class wear spectacles. Find the ratio of the number of pupils who do not wear spectacles to the number of pupils who wear spectacles in the class.

Ans: _____

- 19 Express $\frac{2}{7}$ as a decimal. Give your answer correct to 2 decimal places.

Ans: _____

- 20 There are 350 markers in a box. 12% of them are red markers. How many red markers are there in the box?

Ans: _____

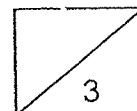

Questions 21 to 30 carry 2 marks each. Show your working clearly in the space provided for each question and write your answers in the spaces provided. For questions which require units, give your answers in the units stated. (20 marks)

21 Johnny stacked 7 unit cubes to form the solid below.

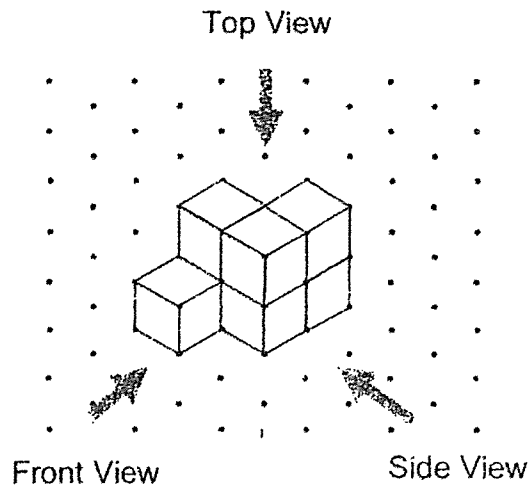

Draw the front view and the top view of the solid on the grids below.

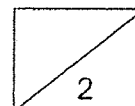
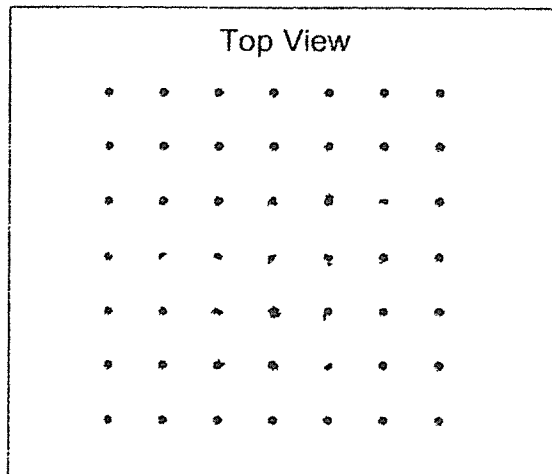
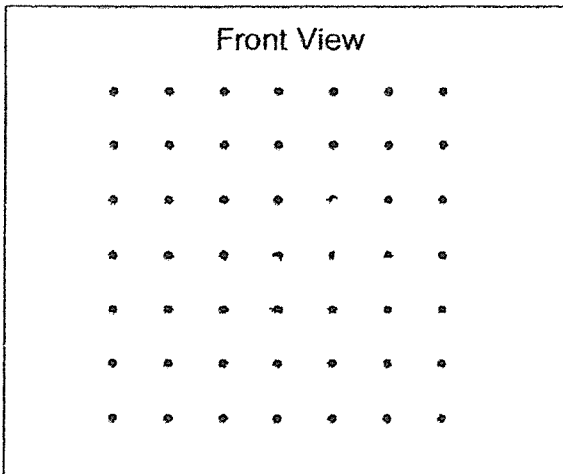

22 Use all the digits 4, 1, 5, 9 to form

- (a) the smallest multiple of 5
- (b) the number closest to 5000

Ans: (a) _____

(b) _____

23 There were 140 red apples and some green apples in a crate. For every 5 red apples, there were 2 green ones. How many apples were there in all?

Ans: _____

24 Daley had $\frac{9}{10}$ m of yarn. He used $\frac{5}{6}$ of it to knit a small pouch. How many metres of yarn did he use? Give your answer as a fraction in its simplest form.

Ans: _____ m

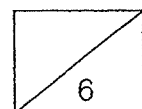

- 25 The table shows the parking charges at a car park.

PARKING CHARGES	
For the first hour	\$1.60
For every subsequent $\frac{1}{2}$ hour or part thereof	\$0.90

How much did Mr Lee pay to park his car there from 2.40 p.m. to 5.00 p.m.?

Ans: \$ _____

- 26 In the diagram below, ABC is an isosceles triangle.
 $AC = BC$, $\angle ACY = 132^\circ$ and XY is a straight line. Find $\angle ABX$.

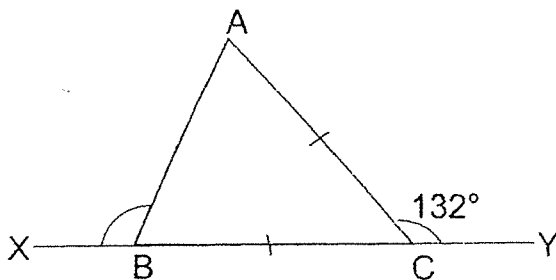

Ans: _____ °

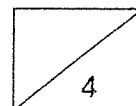

- 27 The bar graph shows the number of movies watched by a group of children during the holidays. What percentage of the children watched more than 2 movies?

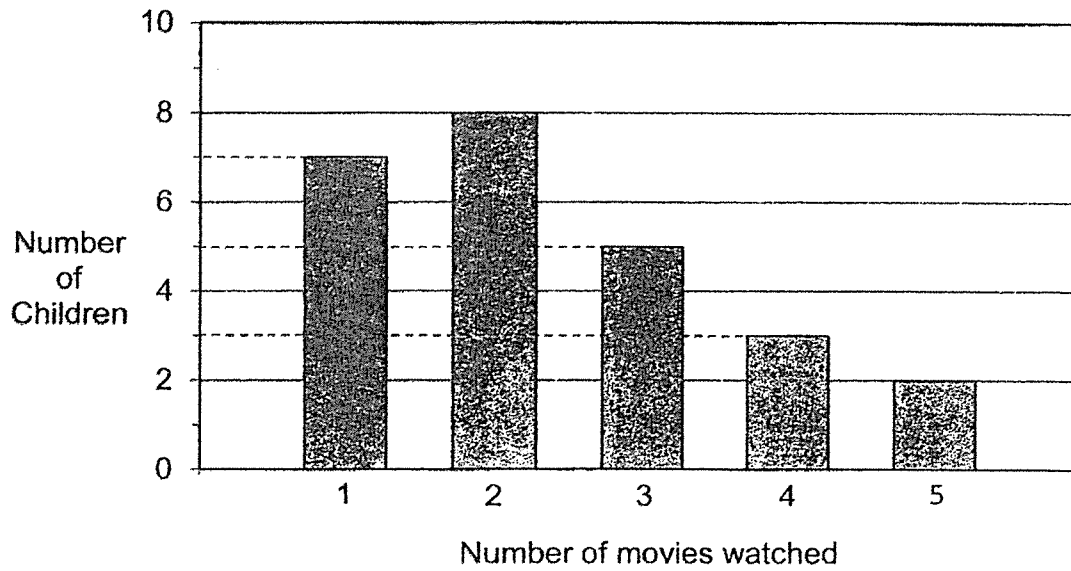

Ans: _____ %

- 28 Kate, Meg and Liz have an average mass of 49 kg. William and Henry have an average mass of 62 kg. What is the average mass of the five children?

Ans: _____ kg

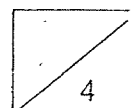

29 4 triangles, A, B, C and D, are shown in the square grid below.

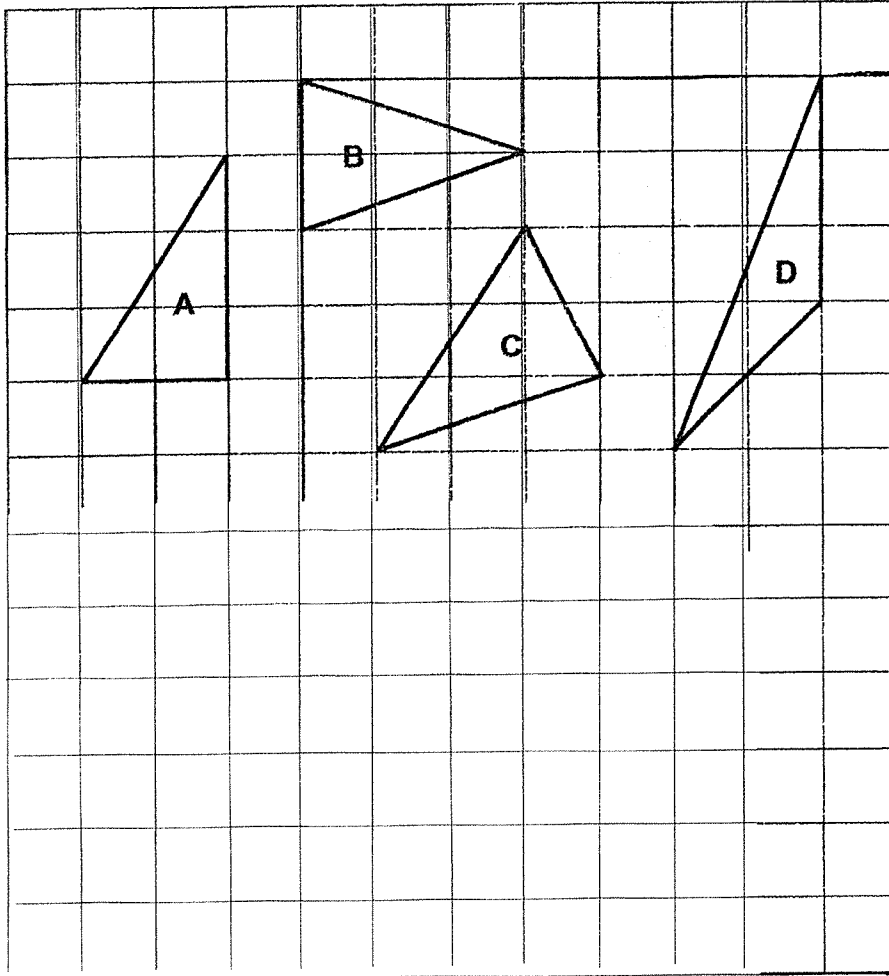

- (a) In the grid, draw a rectangle that has an area 4 times the area of Triangle A. This rectangle must not overlap with any of the triangles shown.
- (b) Name all the triangles that have the same area.

Ans: (b) _____

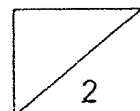

- 30 At first, Pavani had 30 fewer stickers than En Ling. After En Ling gave Pavani some stickers, Pavani had 62 more stickers than En Ling. How many stickers did En Ling give Pavani?

Ans: _____

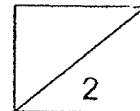

End of Paper



AI TONG SCHOOL
2021
END-OF-YEAR EXAMINATION
PRIMARY 5

MATHEMATICS
PAPER 2

DURATION : 1 h 30 min

DATE : 2 NOVEMBER 2021

INSTRUCTIONS

Do not turn over this page until you are told to do so.
Follow all instructions carefully.
Answer all questions.
Write your answers in this booklet.
The use of an approved calculator is allowed.

Name: _____)

Class: Primary 5 _____

Marks :

Paper 1	45
Paper 2	55
Total	100

Parent's Signature : _____

Date : _____

Paper 2

Questions 1 to 5 carry 2 marks each. Show your working clearly in the space provided for each question and write your answers in the spaces provided. For questions which require units, give your answers in the units stated. (10 marks)

1 Write down one decimal with a value between 7.8 and 7.9

Ans: _____

2 What is the price of the headphones after adding 7% GST?

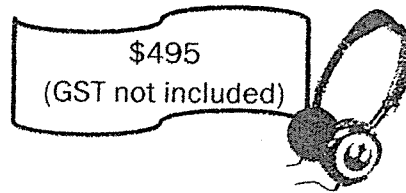

Ans: \$ _____

3 8 kg of rice was repacked into small packets. Each packet contained 200 g of rice. How many such small packets of rice were there?

Ans: _____

- 4 Yasmin made 90 sandwiches for a picnic. For every 20 sandwiches, she used 6 eggs. How many eggs did she use altogether?

Ans: _____

- 5 Rectangle ABCD is made up of 1 big shaded rectangle and 5 identical smaller unshaded rectangles. The area of the shaded rectangle is 35 cm^2 and the length of DC is 15 cm. What is the area of Rectangle ABCD?

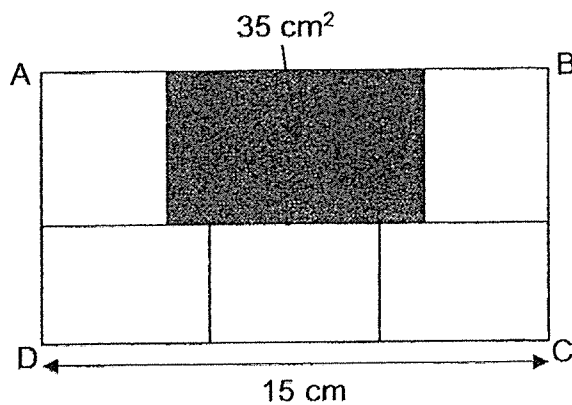

Ans: _____ cm^2

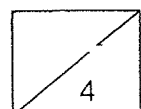

For questions 6 to 17, show your working clearly in the space provided for each question and write the answers in the spaces provided. The number of marks available is shown in the brackets [] at the end of each question or part-question.

(45 marks)

- 6 In the figure below, AOC and BOD are straight lines.
 $\angle AOD = 97^\circ$ and $\angle DOE = 151^\circ$. Find $\angle EOC$.

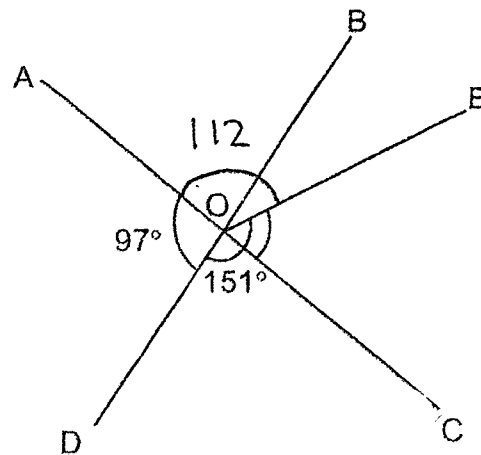

Ans: _____ [3]

- 7 David wants to buy some erasers and pencils with a sum of money.
If he buys 8 erasers and 6 pencils, he will have \$3.50 left.
If he buys 28 erasers and no pencils, he will have no money left.
Each pencil costs \$1.25. How much money does David have?

Ans: _____ [3]

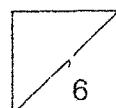

- 8 Janet spent $\frac{2}{5}$ of her money on 5 identical pairs of socks and $\frac{1}{2}$ of the remaining amount on a cap. The cap cost \$9.75. How much did each pair of socks cost?

Ans: _____ [3]

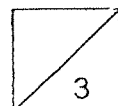

- 9 In the figure below, ABCD is a parallelogram.
 $BC = BE$, $\angle AEB = 73^\circ$ and $\angle ADE = 115^\circ$.

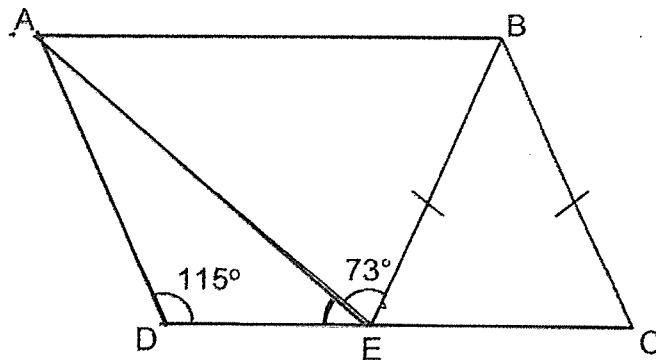

- (a) Each statement below is either true, false, or not possible to tell from the information given. For each statement, put a tick (\checkmark) in the correct column. [1]

Statement	True	False	Not possible to tell
$\angle ADC$ and $\angle ABC$ are equal.			
$\angle BAE$ and $\angle AEC$ add up to 180° .			
Triangle ABE is an isosceles triangle.			

- (b) Find $\angle DAE$.

Ans : (b) _____ [2]

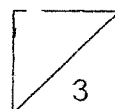

- 10 Four classes 5A, 5B, 5C and 5D donated money at a Sharity event. 5A, 5B and 5C donated a total of \$380. 5C and 5D donated a total of \$208. The ratio of the amount donated by 5C to the total amount donated by the four classes is 1 : 6. What is the amount donated by 5C?

Ans: _____ [3]

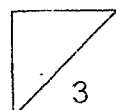

- 11 Last week, a shop sold a different number of cups of bubble tea every day from Monday to Sunday. It sold the fewest cups of bubble tea on Thursday.

The table below shows the number of cups of bubble tea sold at the shop from Monday to Friday only.

Monday	Tuesday	Wednesday	Thursday	Friday
160	134	100	95	156

- (a) What is the average number of cups of bubble tea sold from Monday to Friday?
- (b) The number of cups of bubble tea sold on Thursday was 87 less than the average number of cups of bubble tea sold on Saturday and Sunday. Write down one possible set of values for the number of cups of bubble tea sold on Saturday and on Sunday.

Ans: (a) _____ [2]

(b) _____ and _____ [2]

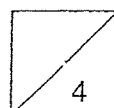

- 12 The figure below is made up of triangle PQR, square PQUV and rectangle RSTU. RT and PT are straight lines. The square has an area of 121 cm^2 . UT is three times as long as VU and ST is 20 cm. What is the area of the shaded triangle PRT?

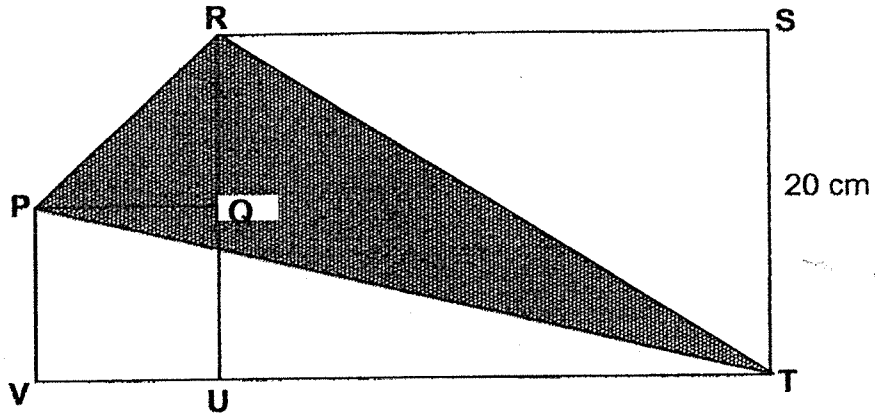

Ans: _____ [4]

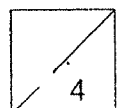

- 13 Sam had \$900 at the end of June. He spent some of this amount from July to October. The line graph below shows the amount of money he had left at the end of each month.

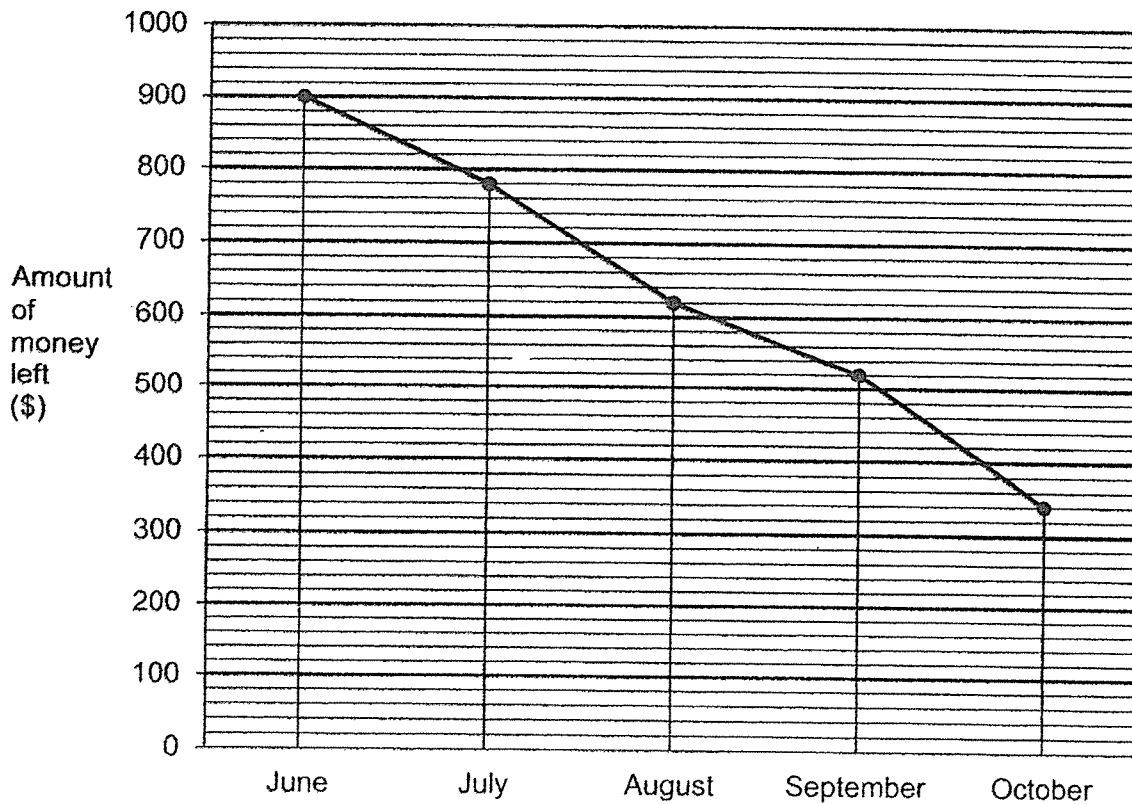

- (a) How much did he have left in October?
- (b) How much did he spend in July?
- (c) What was the ratio of the total amount he spent from ~~June~~ ^{July} to October to the amount he had left in the end?
Give your answer in its simplest form.

Ans: (a) _____ [1]

(b) _____ [1]

(c) _____ [2]

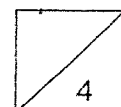

14

An empty rectangular tank measuring 80 cm by 65 cm by 24 cm was placed under 2 taps. Tap A was turned on first, with water filling the tank at a rate of 3 ℓ per minute. After 10 minutes, Tap B was turned on too, with water filling the tank at a rate of 1.74 ℓ per minute. The 2 taps were turned off once the tank was filled to the brim.

- (a) How much water was needed to fill the tank to the brim?
- (b) For how long was Tap B turned on?

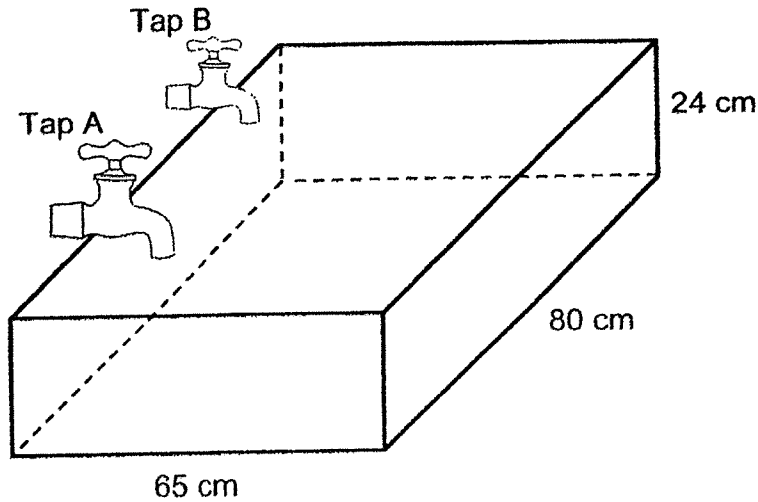

Ans: (a) _____ [1]

(b) _____ [3]

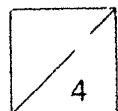

15 Aunt Stacey baked some buns to sell. $\frac{3}{4}$ of the buns were butter buns and the rest were cheese buns. After $\frac{5}{6}$ of the butter buns and 42 cheese buns were sold, she had $\frac{1}{5}$ of all the buns left.

- (a) How many buns did she bake in all?
- (b) What fraction of the buns sold were cheese buns?
Give your answer in its simplest form.

Ans: (a) _____ [3]

(b) _____ [2]

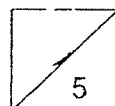

16 50 boxes were used to pack a total of 471 calculators and board games at an event. Each box contained either only 25 calculators or only 6 board games.

(a) Were there more calculators or more board games in all?
Circle the correct item in the answer blank.

(b) How many more?

Ans: (a) calculators / board games [1]
(Circle the correct item)

(b) _____ [3]

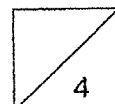

17 The figures below are formed using lines, ovals and rectangles in a pattern.

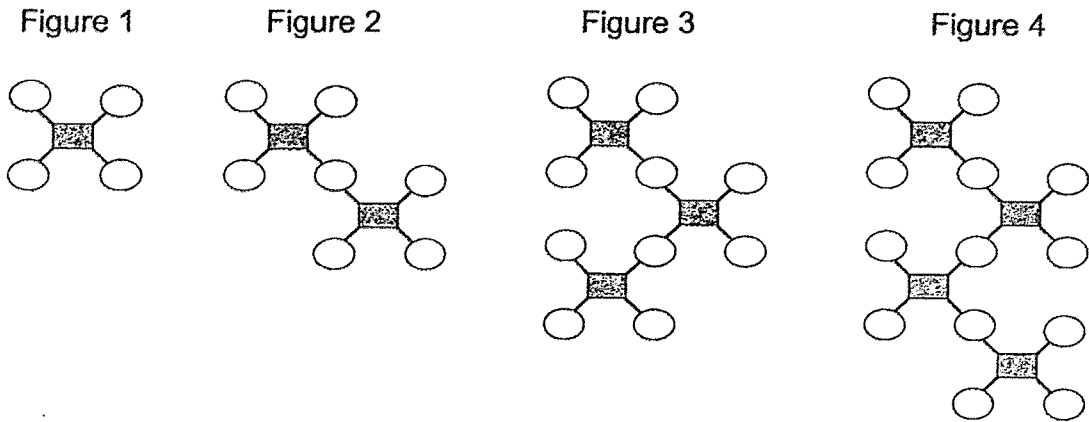

The table below shows the number of lines, ovals and rectangles used to form each figure.

Figure Number	Number of lines	Number of ovals	Number of rectangles
1	4	4	1
2	8	7	2
3	12	10	3
4	16	13	4

- (a) How many lines are there in Figure 5?
 (b) Which figure number has 112 lines?
 (c) A figure has 51 rectangles. How many ovals are there in this figure?

Ans: (a) _____ [1]
 (b) _____ [2]
 (c) _____ [2]

ANSWER KEY

YEAR : 2021
LEVEL : PRIMARY 5
SCHOOL : AI TONG SCHOOL
SUBJECT : MATHEMATICS
TERM : END OF YEAR EXAMINATION

BOOKLET A

Q1	4	Q2	3	Q3	4	Q4	1	Q5	1
Q6	4	Q7	2	Q8	1	Q9	4	Q10	4
Q11	3	Q12	2	Q13	2	Q14	1	Q15	3

BOOKLET B

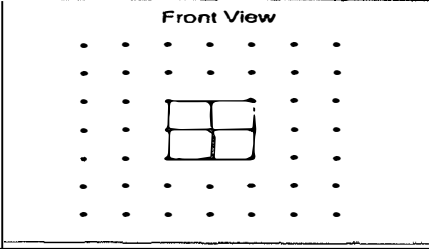
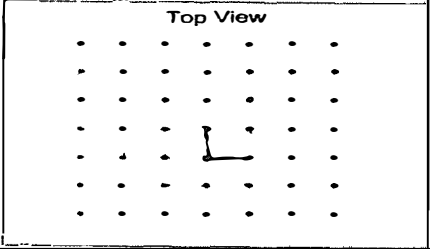
Q16	94.58
Q17	5 children \Rightarrow 4 pizza 1 child \Rightarrow $4 \div 5 =$
Q18	$12 - 7 = 5$ 5:7
Q19	0.29
Q20	$100\% \Rightarrow 350$ $1\% \Rightarrow 3.5$ $12\% \Rightarrow 42$
Q21	<div style="display: flex; justify-content: space-around;"> <div style="border: 1px solid black; padding: 5px; text-align: center;"> <p>Front View</p>  </div> <div style="border: 1px solid black; padding: 5px; text-align: center;"> <p>Top View</p>  </div> </div>
Q22	a) 1495 b) 4951
Q23	$140 \div 4 = 28$ $28 \times 2 = 56$ $140 + 56 = 196$
Q24	$\frac{9}{10} \times \frac{5}{6} = \frac{3}{4}$
Q25	$1.60 + (0.90 \times 3) = \4.30
Q26	$180 - 132 = 048$ $180 - 48 = 132$ $132 \div 2 = 66$ $180 - 66 = 114^\circ$

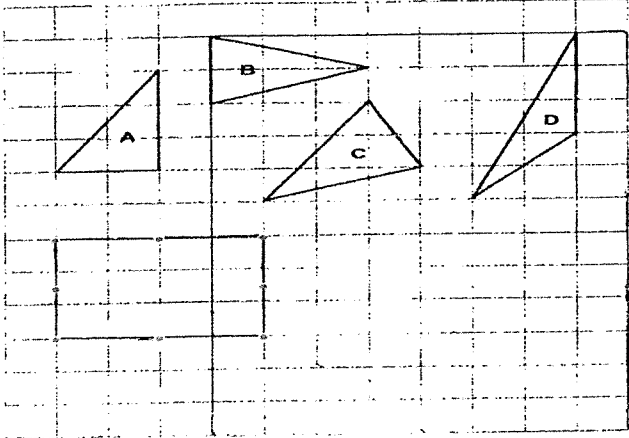
Q27	$5+3+2=10$ $10+7+8=25$ $\frac{10}{25} = \frac{40}{100}$ 40%
Q28	$49 \times 3 = 147$ $62 \times 2 = 124$ $124 + 147 = 271$ $271 \div 5 = 54.2 \text{ kg}$
Q29	 <p>b) A, B, D</p>
Q30	$62 - 30 = 32$ $32 \div 2 = 16$ $16 + 30 = 46$

ANSWER KEY

YEAR : 2021
LEVEL : PRIMARY 5
SCHOOL : AI TONG SCHOOL
SUBJECT : MATHEMATICS
TERM : END OF YEAR EXAMINATION (PAPER 2)



Q1	7.85												
Q2	$100\% \rightarrow 495$ $1\% \rightarrow 4.95$ $1007\% \rightarrow \$529.65$												
Q3	$8000 \div 200 = 40$												
Q4	$90 \div 20 = 4$ R10 $20 \div 2 = 10$ $6 \div 2 = 3$ $6 \times 4 = 24$ $24 + 3 = 27$												
Q5	$35 \div 5 = 7$ $15 - 7 \div 2 = 4$ $7 + 4 + 4 = 15$ $5 + 4 = 9$ $15 \times 9 = 135 \text{cm}^2$												
Q6	$97 - 29 = 68^\circ$												
Q7	$6 \times 1.25 = 7.50$ $7.50 + 3.50 = 11$ $20 \rightarrow 11$ $1U \rightarrow 0.55$ $28 \rightarrow \$15.4$												
Q8	$1.5 \rightarrow 11.75$ $0.5 \rightarrow 6.5$ $2U \rightarrow 6.5 \times 2 = 13$ $13 \div 5 = \$2.60$												
Q9	a) <table border="1" style="margin-left: 20px; border-collapse: collapse; width: 100%;"> <thead> <tr> <th style="width: 33%;">True</th> <th style="width: 33%;">False</th> <th style="width: 33%;">Not possible to tell</th> </tr> </thead> <tbody> <tr> <td style="text-align: center;">✓</td> <td></td> <td></td> </tr> <tr> <td style="text-align: center;">✓</td> <td></td> <td></td> </tr> <tr> <td></td> <td style="text-align: center;">✓</td> <td></td> </tr> </tbody> </table> b) 23°	True	False	Not possible to tell	✓			✓				✓	
True	False	Not possible to tell											
✓													
✓													
	✓												

Q10	<p>A, B, C \rightarrow 380 C, D \rightarrow 208 C: A,B,C,D 1:6 7U \rightarrow 380+208=588 1U \rightarrow 588\div7=\$84</p>
Q11	<p>160+134+100+95+156=645 645\div5=129 95+87=182 182\times2=364 a) 129 b) 183 and 181</p>
Q12	<p>11\times11=121 11\times3=33 (133\times20)+(11\times11)+($\frac{1}{2}$$\times1\times$9)=\$30.5 $\frac{1}{2}$$\times11\times33\times$20=330 \$30.5-242-330=258.5cm²</p>
Q13	<p>900-780=120 780-340=440 440+120=560 900-340=560 560:340 = 28:17 a)\$340 b)\$120 c)28:17</p>
Q14	<p>1m \rightarrow 3litre Tap A+Tap B \rightarrow 3+1.74=4.75 124.8\div3=94.8 94.8\div4.74=20 a)124.8litre b)20min</p>
Q15	<p>$\frac{10}{5}$ +40U=8U left \rightarrow 8U sold 40U-8U=32U butter \rightarrow 5U\times5=25 cheese \rightarrow 32U-25U=7U 7U \rightarrow 42 1U=42\div7=6 40U \rightarrow 40\times6=240 32U=32\times6=192 $\frac{42}{192} = \frac{7}{32}$ a)240 b)$\frac{7}{32}$</p>

Q16	$25 \times 25 = 625$ $25 \times 6 = 150$ $625 - 150 = 475$ $246 - 225 = 21$ a) **board games** b)21
Q17	$16 + 4 = 20$ $112 \div 4 = 28$ $61 - 4 = 47$ $47 \times 3 = 141$ $13 + 141 = 154$ a)20 b)28 c)154