

Name: _____ ()

Class: Primary 4 _____

CHIJ ST NICHOLAS GIRLS' SCHOOL



Primary 4
End-Year Assessment
SCIENCE
BOOKLET A

29 October 2020

Total Time for Booklets A and B: 1 hour 45 minutes

28 questions
56 marks

Do not open this booklet until you are told to do so.
Follow all instructions carefully.
Answer all questions.

This booklet consists of 18 printed pages.

Section A (28 x 2 marks = 56 marks)

For each question from 1 to 28, four options are given. One of them is the correct answer. Make your choice (1, 2, 3 or 4). Shade the correct oval (1, 2, 3 or 4) on the Optical Answer Sheet provided.

1. Yan Ling observed the stages of growth of a seed to an adult plant over a period of time and recorded her observations below.

- A white flowers bloom
- B shoot grows upwards
- C leaves start to develop
- D root grows downwards
- E fruits starts to appear

Which of the following correctly shows the order in which the seed develops into an adult plant?

- (1) B, C, D, E, A
- (2) B, D, E, A, C
- (3) D, B, A, E, C
- (4) D, B, C, A, E

2. Which one of the following is the function of a leaf on a plant?

- (1) makes food
- (2) absorbs water
- (3) holds plant upright
- (4) absorbs mineral salts

3. The diagram below shows a tree.

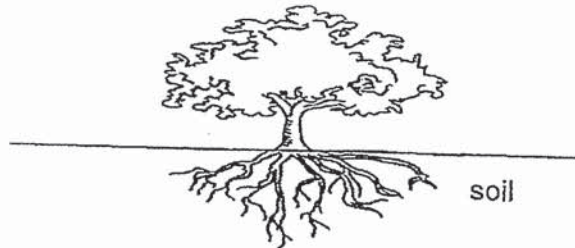

During a thunderstorm, Cindy observed that the tree did not fall.

Which one of the following statements best explains her observation?

- (1) The roots store food for the tree.
 - (2) The roots absorb water for the tree.
 - (3) The roots absorb minerals for the tree.
 - (4) The roots hold the tree firmly to the soil.
4. Which of the following statement(s) is/are correct about a rose plant and a staghorn fern?
- A Both are flowering plants.
 - B Both make their own food.
 - C Both reproduce by spores.
 - D Both have leaves, stem and roots.
- (1) A only
 - (2) A and C only
 - (3) B and D only
 - (4) B, C and D only

5. The diagram below shows two similar plants A and B.

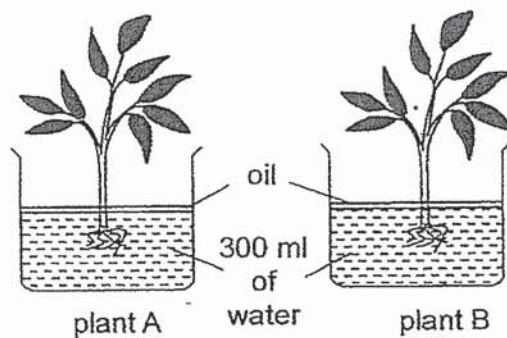

Plant A was placed in a dark room and plant B was left in the sun. The height of the plant was measured over a number of days and recorded in the graph below.

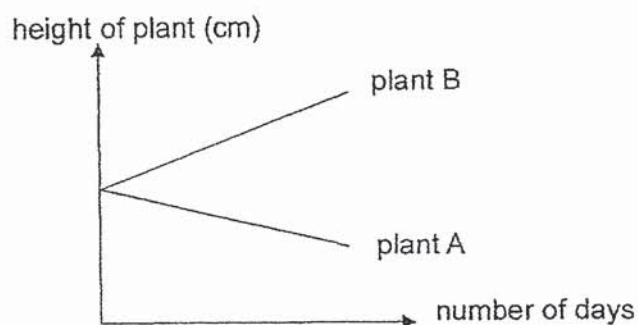

What is the aim of the experiment?

- (1) To find out if plants need minerals to grow.
- (2) To find out if plants can grow without water.
- (3) To find out if the amount of water affected plant growth.
- (4) To find out if the amount of sunlight affected plant growth.

6. Study the flow chart below.

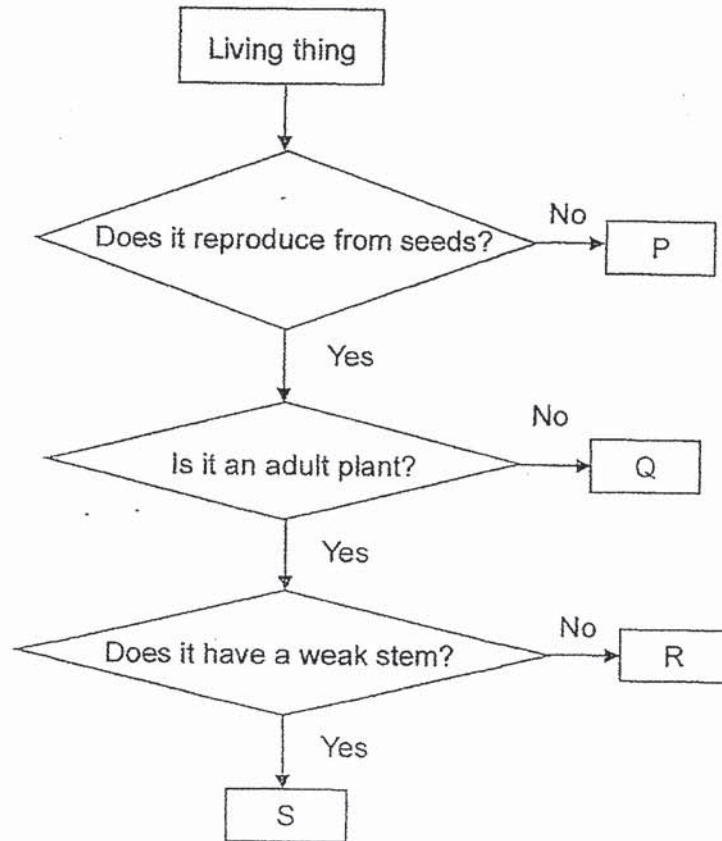

Which of the following living things P, Q, R or S best represents plant Z shown below?

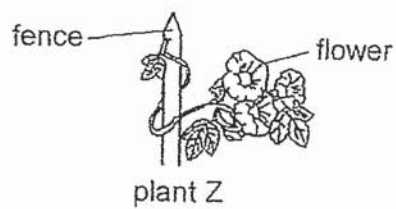

- (1) P
- (2) Q
- (3) R
- (4) S

7. The diagram below shows a plant growing in a garden.

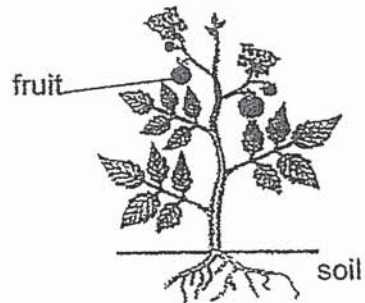

Which of the following statement(s) is/are correct?

- A It can make food.
- B It has a weak stem.
- C It is a flowering plant.

- (1) B only
- (2) A and C only
- (3) B and C only
- (4) A, B and C

8. Which statement is true about most amphibians?

- (1) They have tails.
- (2) They are covered with scales.
- (3) They give birth to their young.
- (4) They can live on land and in water.

9. A, B, C and D are the various stages in the life cycle of a butterfly.



Which of the following correctly shows the life cycle of a butterfly?

(1)

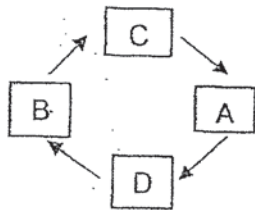

(2)

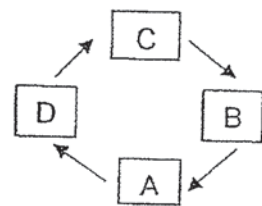

(3)

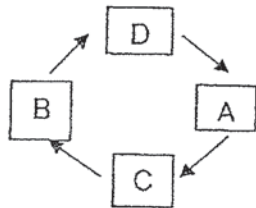

(4)

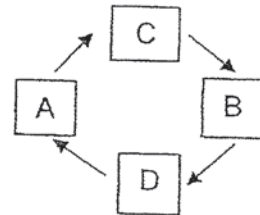

10. The diagram below shows a dolphin.

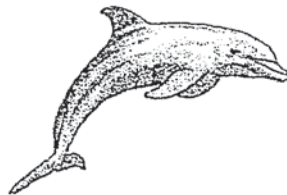

The dolphin is a mammal because _____.

- (1) it has fins
- (2) it can swim
- (3) It has a tail
- (4) it has hair on its body

11. Study the flow chart below.

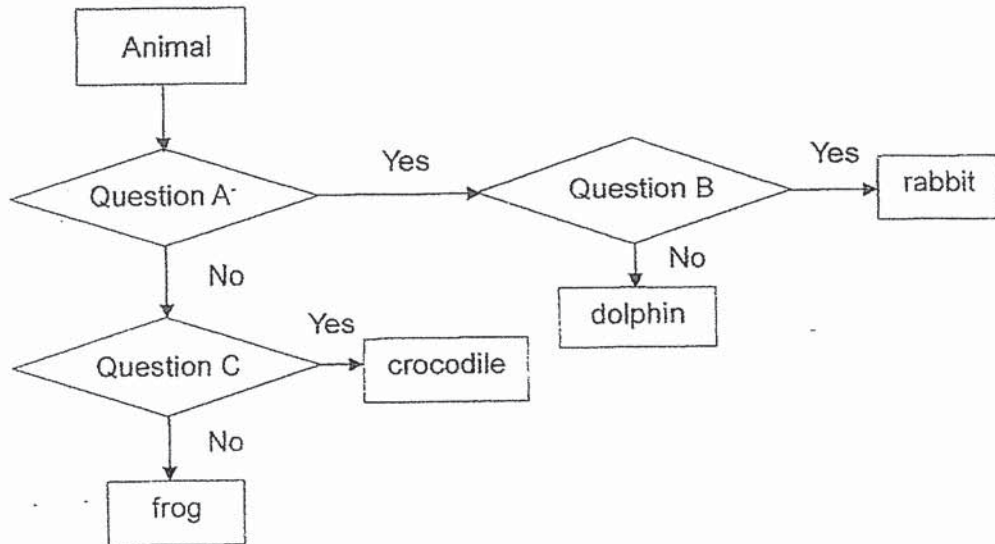

Which of the following best represents questions A, B and C?

	Question A	Question B	Question C
(1)	Does it breathe through lungs?	Does it have hair?	Does it lay eggs?
(2)	Does it live on land?	Does it give birth to young alive?	Does it have hair?
(3)	Does it give birth to young alive?	Does it live on land?	Does it have scales?
(4)	Does it lay eggs?	Does it live in water?	Does it breathe through lungs?

12. Which organ system is shown in the diagram?

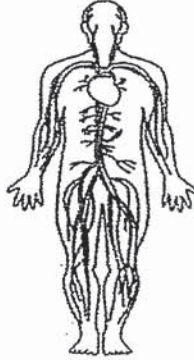

- (1) skeletal system
- (2) muscular system
- (3) circulatory system
- (4) respiratory system

13. Ahmad observed that there were gaps along the train tracks at the MRT station.

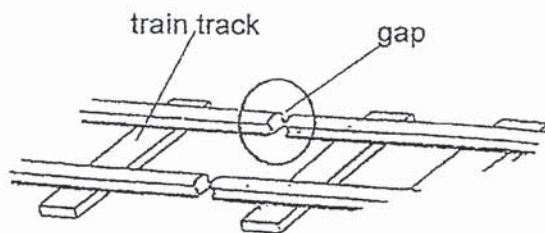

Which of the following statements best explains Ahmad's observations?

- (1) The gaps allow the tracks to gain heat and expand on a hot day.
- (2) The gaps allow the tracks to lose heat and contract on a hot day.
- (3) The gaps allow the tracks to lose heat and expand on a cold day.
- (4) The gaps allow the tracks to gain heat and contract on a cold day.

14. Carine places a metal spoon in a cup of hot coffee.

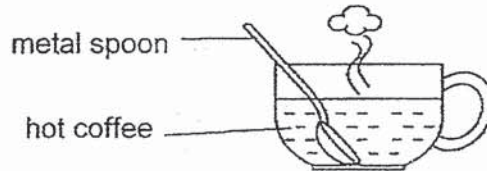

The spoon becomes hotter after a while.

Which one of the following statements explains this?

- (1) The cup loses heat to the hot coffee.
(2) The spoon loses heat to the hot coffee.
(3) The spoon gains heat from the hot coffee.
(4) The hot coffee gains heat from the spoon.
15. Which of the following beakers contains the most heat?

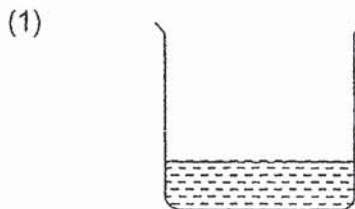

40 ml of water at 50 °C

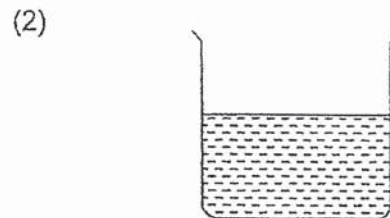

80 ml of water at 90 °C

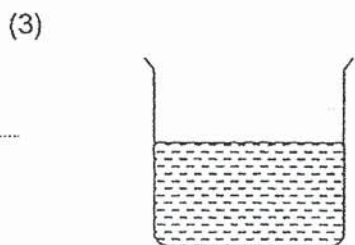

80 ml of water at 50 °C

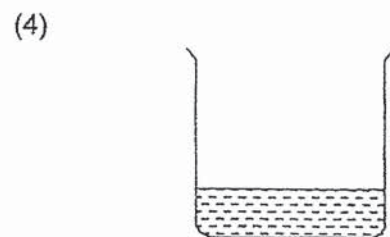

40 ml of water at 90 °C

16. Jimmy filled beakers A and B with the same amount of water. He then poured all the water from beaker A into beaker B as shown.

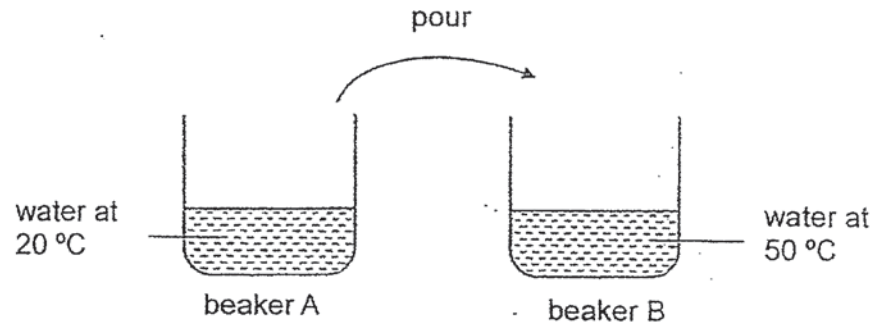

What is the most likely temperature of the mixture of water in beaker B?

- (1) 19 °C
 - (2) 36 °C
 - (3) 53 °C
 - (4) 70 °C
17. Study the diagram below.

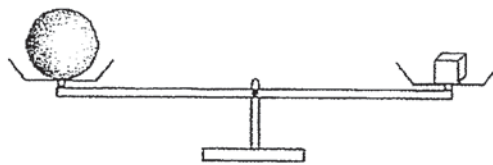

Which of the following statements is true?

- (1) Both objects have the same size.
- (2) Both objects have the same mass.
- (3) Both objects have the same shape.
- (4) Both objects have the same volume.

18. Siva conducted an experiment to find out which metal block X or Y has a greater volume. She placed block X into beaker A and block Y into beaker B before comparing their water levels.

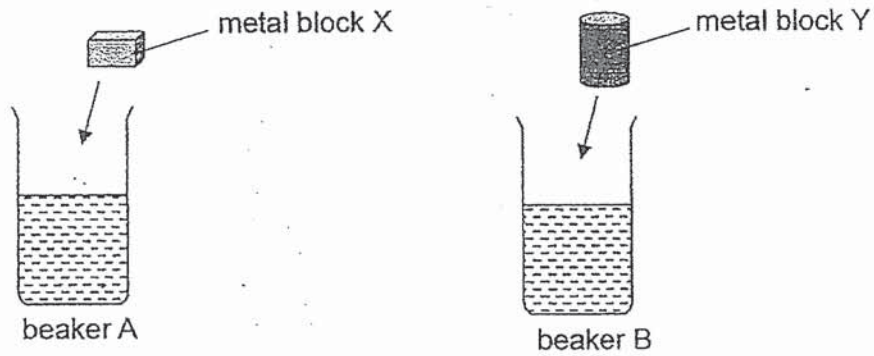

Which of the following variable(s) should she keep the same if she wants to conduct a fair test?

- A size of the beakers
 - B volume of the metal blocks
 - C amount of water in each beaker
 - D shape of the metal blocks
- (1) A only
(2) B only
(3) A and C only
(4) B and D only

19. The diagram below shows the volume of two containers Y and Z.

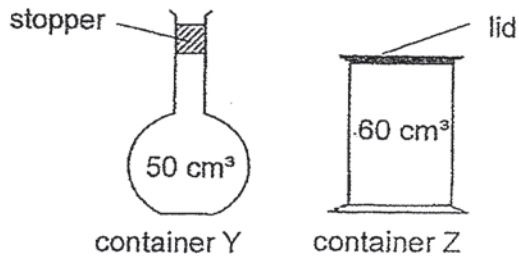

Using a syringe, Eva pumped in another 20 cm³ of air into container Y. Then she placed a 15 cm³ wooden block into container Z.

What is the volume of air in each container in the end?

	container Y	container Z
(1)	50	45
(2)	70	75
(3)	60	50
(4)	30	60

20. Which one of the following is a source of light?

(1)



a flower

(2)



the moon

(3)



a watermelon

(4)



a candle flame

21. The diagram below shows a periscope.

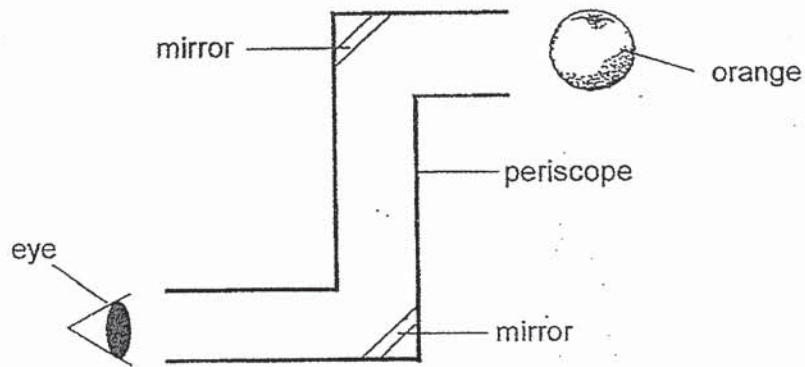

Which of the following statements correctly describe why Fatimah can see the image of an orange through a periscope?

- A Light can bend.
- B Light can be reflected.
- C Light travels in a straight line.
- D Light is given off by the orange.

- (1) A and C only
- (2) A and D only
- (3) B and C only
- (4) B and D only

22. Aziz had three objects as shown below.

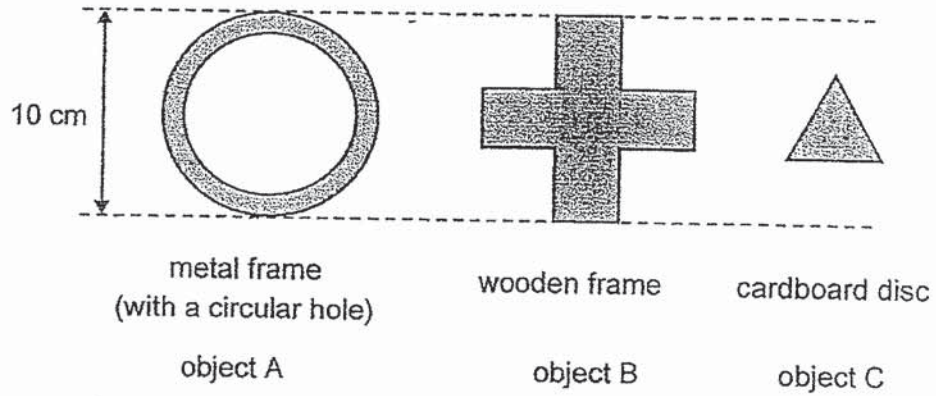

All three objects were placed at the positions as shown in the diagram below. A torch was then used to cast a shadow on a smooth wall.

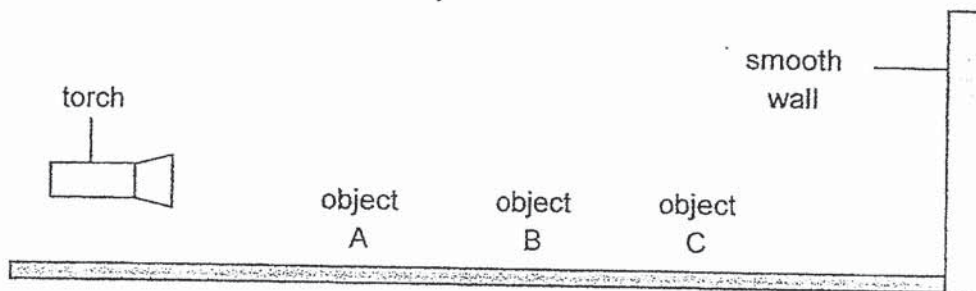

Which one of the following is the most likely shadow cast on the smooth wall?

(1)



(2)



(3)



(4)



23. A dog walked past a lamp post from position A to C.

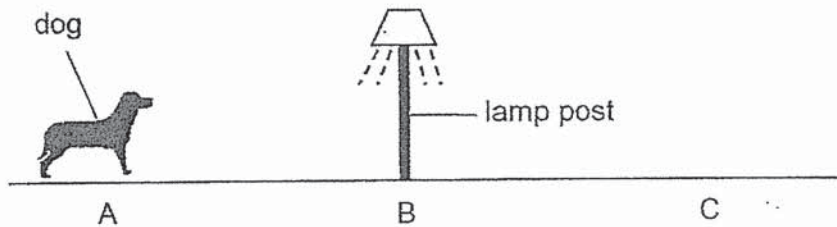

Which one of the following graphs shows how the length of the dog's shadow would change as it walked from position A to C?

(1)

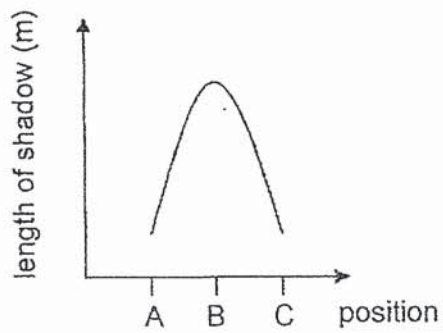

(2)

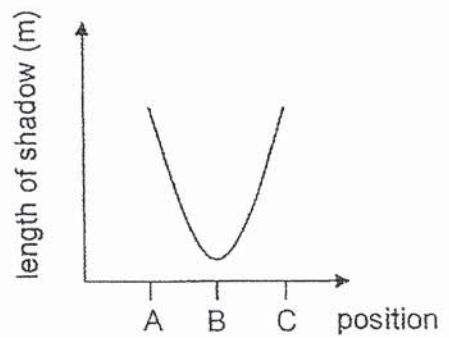

(3)

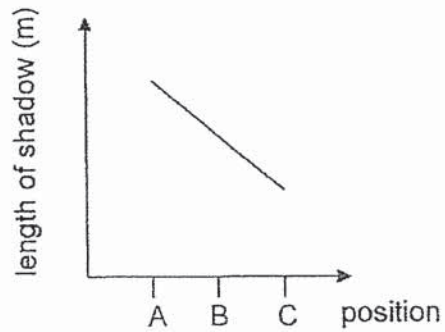

(4)

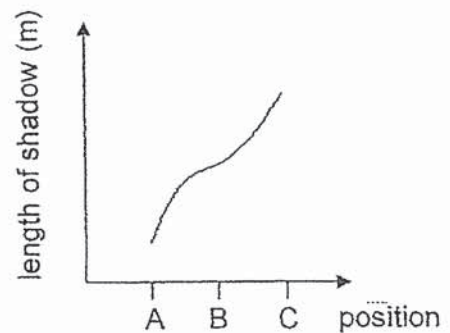

24. Look at the picture below.

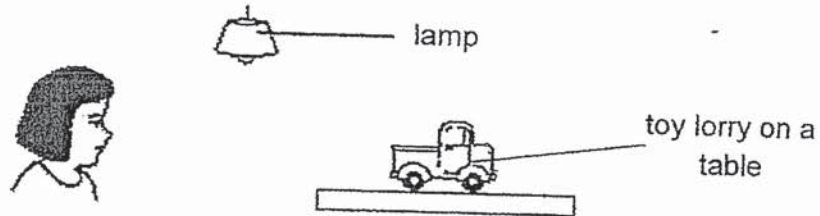

Which one of the following shows the correct path that light takes for Mikaela to see the toy lorry?

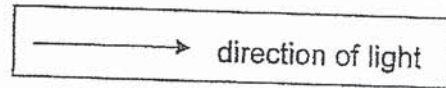

(1)

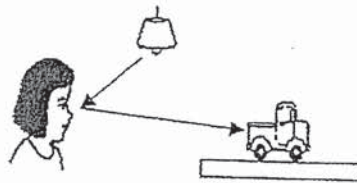

(2)

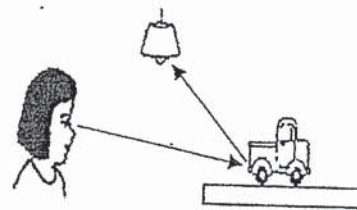

(3)

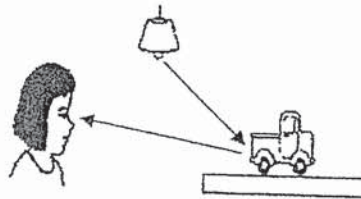

(4)

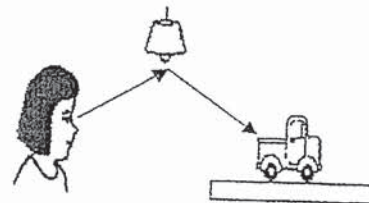

25. The diagram below shows a hammer.



Metal is used to make part X of the hammer because metal _____.

- (1) can reflect light
- (2) does not break easily
- (3) can bend without breaking
- (4) does not allow light to pass through

26. In which one of the following will the two magnets push each other away?

(1)



(2)

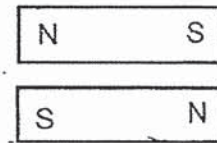

(3)

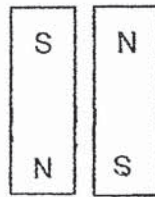

(4)

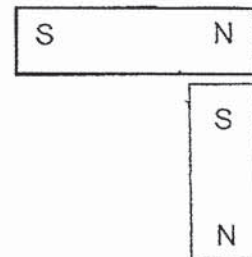

27. Jessie placed magnet M on a table. She then placed two similar balls X and Y next to magnet M as shown below.



When she lifted up magnet M, ball X remained attached to the magnet but ball Y did not.

Which of the following statements explains why ball Y did not remain attached to magnet M?

- (1) Ball X has a greater magnetic strength than ball Y.
- (2) Magnet M has lost its magnetism so it could not attract ball Y.
- (3) Ball Y is made of a non-magnetic material so it could not be attracted by magnet M.
- (4) The magnetic attraction in the middle of magnet M is not strong enough to attract ball Y.

28. Magnet P was hung on a spring above the ground as shown in the diagram below.

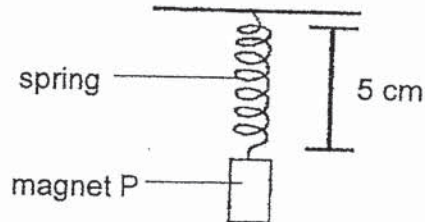

Three objects X, Y and Z were secured with a wooden block and placed one at a time directly below magnet P. The diagram below show the results when the objects were placed below magnet P.

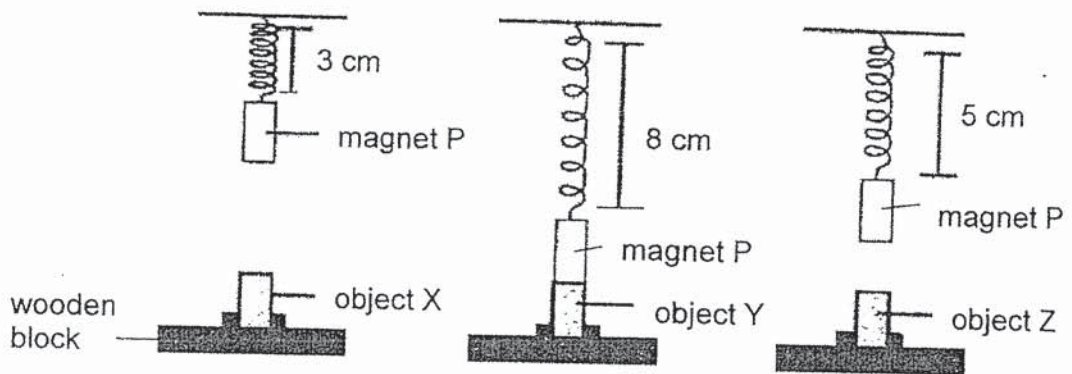

Based on the observations above, which one of the following statements is true?

- (1) Object X is a magnet.
- (2) Object Z is made of iron.
- (3) Objects Y and Z are magnets.
- (4) Object Y is made of a non-magnetic material.

End of Booklet A

Name : _____ ()

Class : Primary 4 _____

CHIJ ST NICHOLAS GIRLS' SCHOOL



Primary 4
End-Year Assessment 2020
SCIENCE

BOOKLET B

29 October 2020

Total Time for Booklets A and B: 1 hour 45 minutes

13 questions
44 marks

Do not open this booklet until you are told to do so
Follow all instructions carefully.
Answer all questions.

This paper consists of 13 printed pages.

Booklet A	56
Booklet B	44
Total	100

Parent's Signature/Date

Section B (44 marks)

For questions 29 to 41, write your answers in this booklet.
The number of marks available is shown in the brackets [] at the end of each question or part question.

29. The diagram below shows the life cycle of a frog and a cockroach.

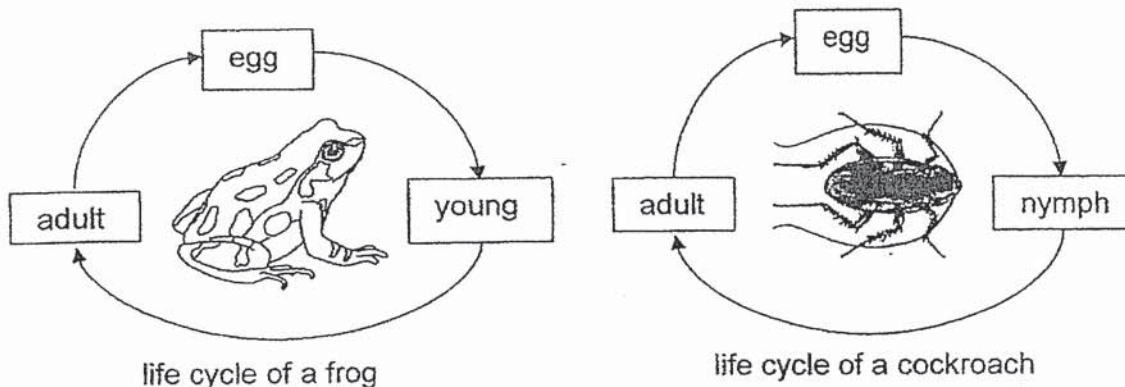

(a) State two differences between the life cycle of the frog and the cockroach.
(Do not describe the physical characteristics of the animals)

[2]

(i) _____

(ii) _____

(b) Name another organism that has the same number of stages in its life cycle as the frog and the cockroach.

[1]

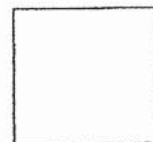

30. The diagram below shows animal P and Q.

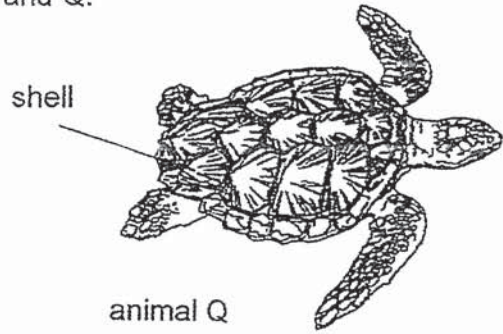
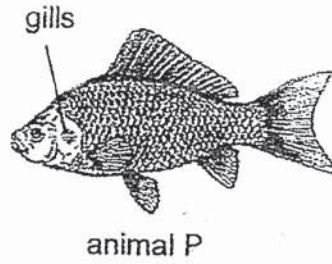

- (a) State one similarity between animal P and Q based on their reproduction method. [1]

- (b) Based on the diagram above, which animal group does animal Q belong to? Explain your answer. [1]

- (c) State a function of the gills and the shell of animal P and Q respectively. [2]

Function of gills:

Function of shell:

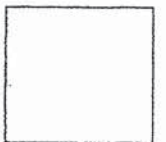

31. Study the classification chart below.

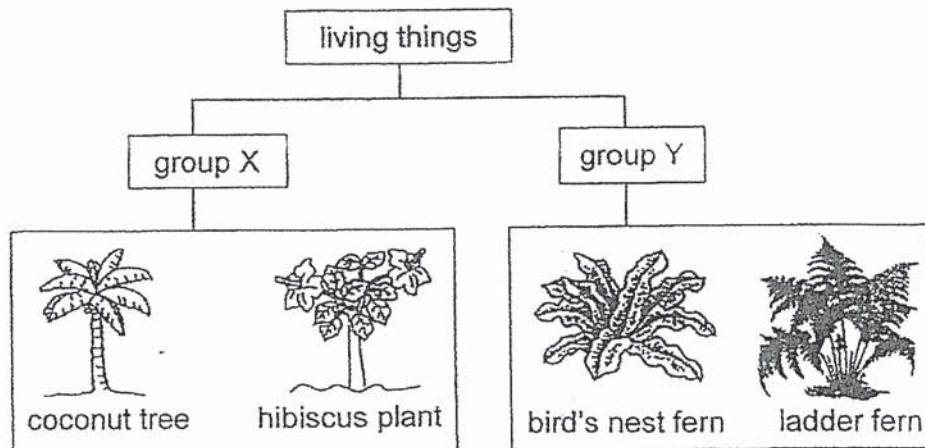

(a) Choose the correct words from the box below to give suitable headings for group X and Y. [2]

flowering plant non-flowering plant fungi bacteria

Group X: _____

Group Y: _____

The diagram below shows organism Z.



(b) Based on the classification chart, in which group X or Y should Jane place organism Z? Explain your answer. [1]

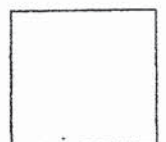

32. Study the diagram below.

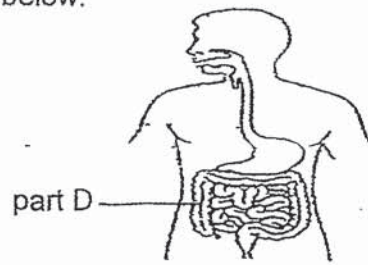

(a) Name the human organ system shown above. [1]

(b) Name part D and state its function. [1]

Claudia carried out an experiment to find out how the size of the bread affects the rate of digestion. She put some bread into each set-up as shown below.

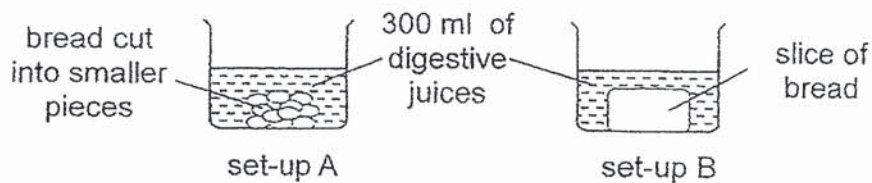

Set-up	Amount of bread at the start of the experiment (g)	Amount of bread at the end of the experiment (g)
A	100	30
B	100	70

(c) Based on her experiment, what is the relationship between the size of the bread and the rate of digestion? [1]



33. Raj wanted to use a bar magnet to magnetise an iron nail as shown below.

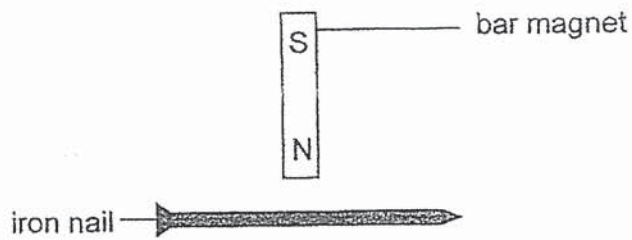

(a) Explain how Raj should stroke the iron nail to magnetise it. [2]



Raj placed a magnet near a steel rod. The steel rod moved towards the magnet.

(b) The magnet exerts a _____ on the steel rod. [1]

(c) Choose the correct word from the box to answer the question below. [1]

flexible	magnetic	strong
----------	----------	--------

Raj's observation shows that steel is a _____ material.



34. Study the diagram below. The iron nail became an electromagnet with the following set-up.

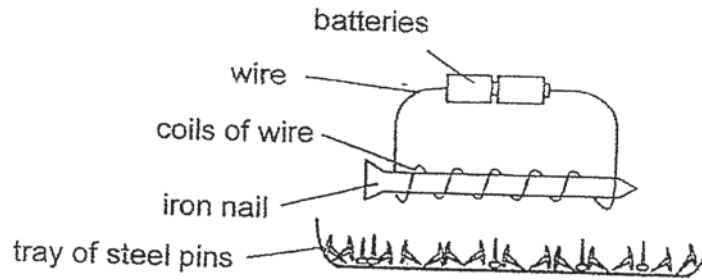

Eric conducted an experiment with four electromagnets A, B, C and D and recorded the number of steel pins attracted by the electromagnets in the table below.

Electromagnet	Number of coils of wire around the nail	Number of batteries	Number of steel pins attracted
A	10	2	8
B	15	3	14
C	20	4	18
D	10	3	10

- (a) Based on the table above, which two electromagnets should he use to find out how the number of batteries affects the strength of the electromagnet? [1]
-
- (b) What is the relationship between the number of coils of wire around the nail and the number of steel pins attracted by the electromagnet? [1]
-
-
-
- (c) Without changing the number of batteries, state another way to increase the number of steel pins attracted by electromagnet B. [1]
-
-



35. Timothy filled beaker A with pebbles and beaker B with water as shown in the diagram below.

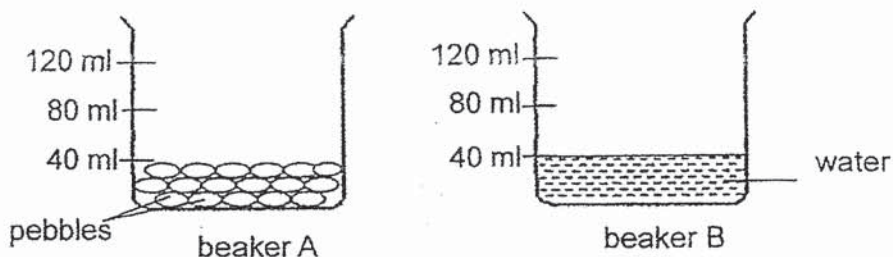

- (a) Timothy said that the pebbles are not solid as they take the shape of the beaker. Do you agree with him? Explain your answer. [1]

- (b) Timothy poured all the water from beaker B into beaker A.

Draw the water level in the diagram below. [1]

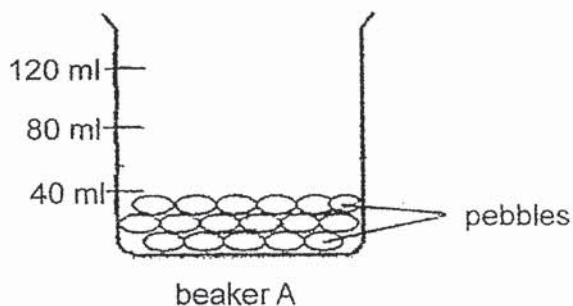

- (c) Explain your answer in (b) [1]

- (d) State what matter is. [1]

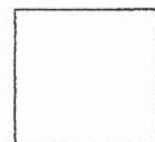

36. The diagram below shows a bottle of juice.

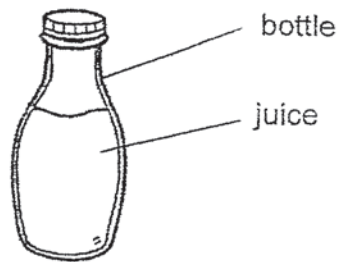

Complete the sentences to state if the parts are solid, liquid or gas.

(a) The juice is a _____ [1]

(b) The bottle is a _____ [1]

The diagram below shows a small stone.

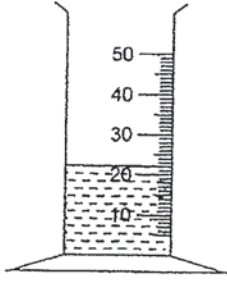

(c) How can Andy measure the mass of the stone? Tick (✓) the correct apparatus he should use to measure the mass of the stone. [1]

Apparatus	Tick (✓)
 <p data-bbox="829 1377 1082 1411">electronic balance</p>	
 <p data-bbox="826 1668 1088 1702">measuring cylinder</p>



37. Nevin conducted an experiment in a dark room as shown below. When no material was placed between the torch and the light sensor, the amount of light detected was 800 units.

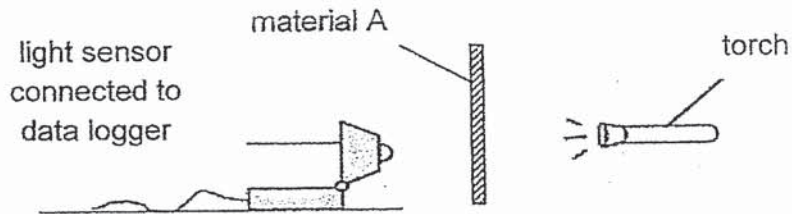

Nevin placed material A between the torch and the light sensor. He recorded the amount of light detected by the light sensor connected to a data logger in the table below. He repeated his experiment with materials B, C and D.

Material	Amount of light detected (units)
A	0
B	730
C	415
D	120

- (a) What was he trying to find out from his experiment? [1]

- (b) Based on the table, which material A, B, C or D is most likely made of cardboard? [1]

- (c) Other than the position of the light sensor and the torch, state two other variables that should remain the same for Nevin's experiment to be fair. [2]

(i) _____

(ii) _____

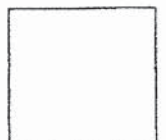

38. Aminah shines a torch on a ball and a shadow is formed on a smooth wall.

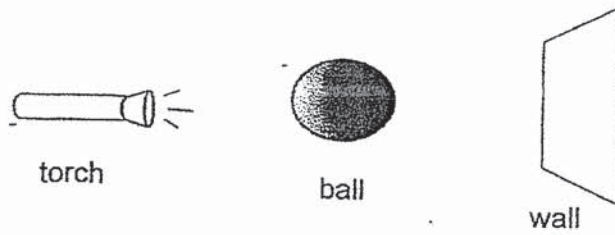

(a) A shadow is formed when light is _____ by an object. [1]

(b) Draw the shadow of the ball that is formed on the wall. [1]

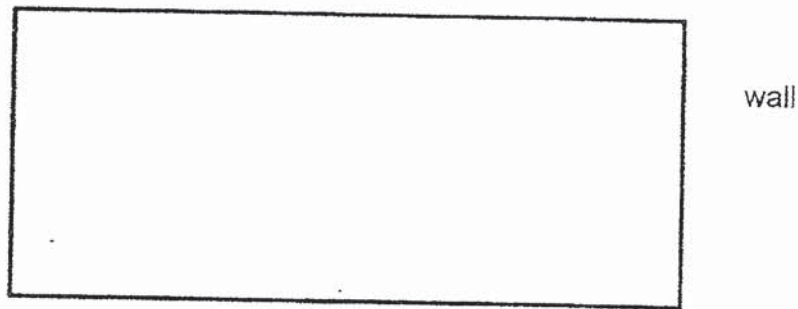

Aminah carried out an experiment in a dark room as shown below.

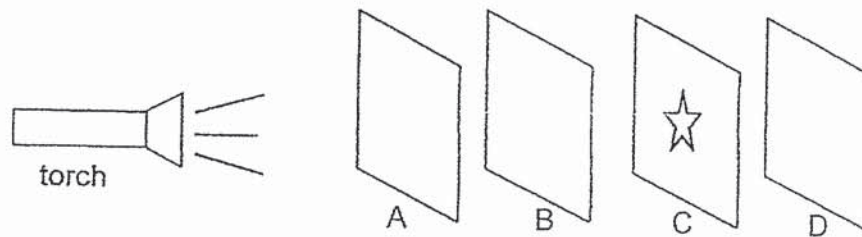

She arranged the torch and four similar-sized sheets made of different materials A, B, C and D in a straight line. Sheet C has a star-shaped cut-out in the middle. When the torch was switched on, a star-shaped patch of light was seen on sheet D only.

(c) Based on her experiment, which of the materials A, B, C and/or D do not allow light to pass through? [1]

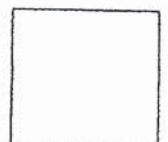

39. Steve placed three different materials Q, R and S in a water bath as shown below.

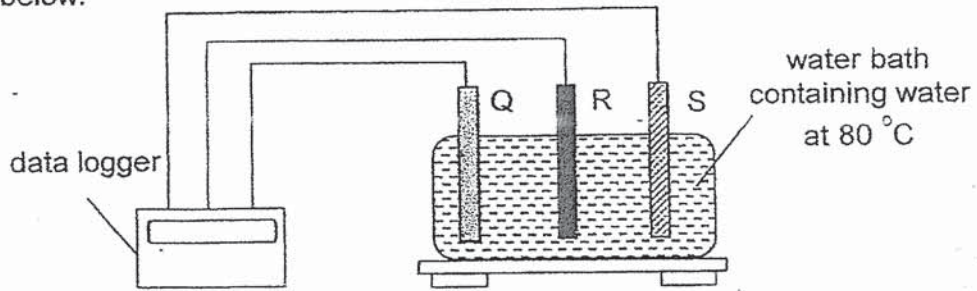

Each material was connected to a data logger and the changes in their temperature were recorded in the table below.

Time (min)	Temperature (°C)		
	Material Q	Material R	Material S
0	25	25	25
5	33	39	28
10	40	55	32
15	51	80	37

- (a) State what heat is. [1]

- (b) Based on the table, what can he conclude from his experiment? [1]

The diagram below shows a ladle.

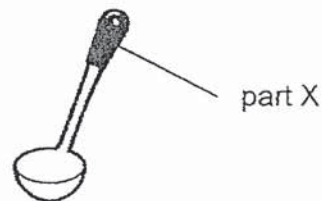

- (c) Based on the results of the experiment, which material Q, R or S is most suitable for making part X of a ladle? Explain your answer. [2]

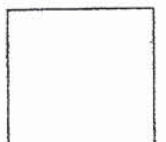

40. The diagram below shows a kettle.

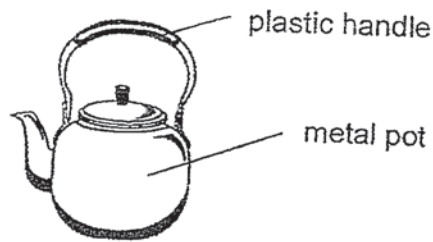

- (a) The handle is made of plastic because it is a _____ conductor of heat. [1]
- (b) The pot is made of metal because it is a _____ conductor of heat. [1]

Khairul found two glasses A and B stuck together as shown below.

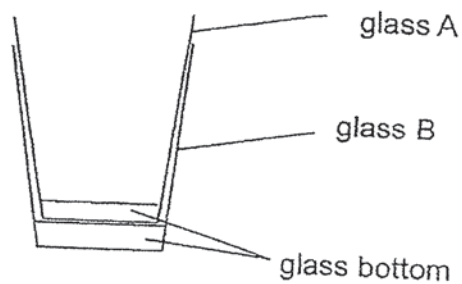

- (c) State how he can separate both glasses safely without using force to pull the two glasses apart. [1]



41. The diagram below shows a t-shirt on a hanger.

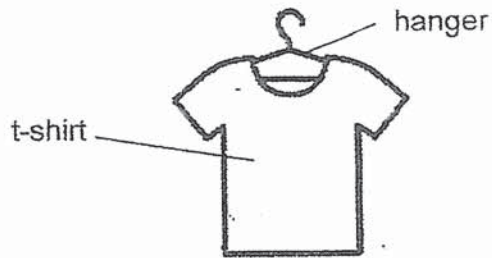

(a) Suggest a material for making the t-shirt and hanger and give a reason for your choice.

[3]

	Material	Reason for your choice
t-shirt		
hanger		

End of Booklet B

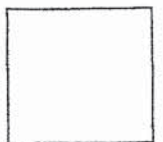

ANSWER KEY

YEAR : 2020

LEVEL : PRIMARY 4

SCHOOL ; CHIJ ST NICHOLAS GIRLS' SCHOOL

SUBJECT: SCIENCE

TERM: END YEAR ASSESSMENT

BOOKLET A

Q1	4	Q2	1	Q3	4	Q4	3	Q5	4
Q6	4	Q7	2	Q8	4	Q9	1	Q10	4
Q11	3	Q12	3	Q13	1	Q14	3	Q15	2
Q16	2	Q17	2	Q18	3	Q19	1	Q20	4
Q21	3	Q22	3	Q23	2	Q24	3	Q25	2
Q26	1	Q27	4	Q28	1				

BOOKLET B

Q29

ai) A young frog does not look like the adult while a young cockroach looks like the adult.

aii) The frog lays its egg in water while a cockroach lays its egg on land.

b) Chicken

Q30.

a) Both animal P and Q reproduce by laying eggs.

b) Reptile.

c) The function of gills allow the animals to breathe underwater.

The function of the shell is to protect the animal soft body.

Q31.

a) Group X: flowering plant

Group Y : non-flowering plant

b) Group X. As organism Z bears fruits thus it is a flowering plant.

Q32.

a) Digestive system

b) Large intestine. To absorb water from the undigested food.

c) As the amount of bread that is broken down in to smaller pieces increases the time for it to be digested decreases.

Q33.

a) Raj has to stroke it on either the north or south side in the same direction using the same pole repeatedly.

b) magnetic force

c) Magnetic

Q34.

a) A and D

b) As the number of coils around the iron nail increases, the number of steel pins attracted increases.

c) Coil more coils of wire around the iron nail.

Q35.

a) No as the pebbles are solid and solids have a definite shape.

c) b) There are air spaces in between each of the pebbles so when water is poured into beaker A, air escapes and water displaces it thus occupying the space where there were air initially.

d) c) Has mass and it occupies space.

Q36.

a) liquid

b) solid.

c) Electronic balance

Q37.

a) Nevin is trying to find out how much light is able to pass through each material.

b) A

ci) Thickness of the material.

cii) amount of light from the torch.

Q38.

a) Blocked.

b)



c) C and D

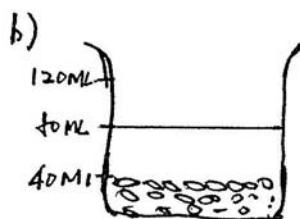

Q39.

a) Heat is a form of energy

b) Material R is the best conductor of heat

c) Material S. As it gained heat the slowest thus, a handle needs to be a poor conductor of heat so that the user had don't burn.

Q40.

a) poor

b) good

c) You can put glass B in hot water and put glass A in cold water.

Q41.

	Material	Reason of your choice
T-shirt	cotton	It is flexible so the user can wear it
Hanger	plastic	it is waterproof and strong enough to hold the weight of a T-shirt.