



AI TONG SCHOOL

**2020 END-OF-YEAR EXAMINATION
PRIMARY FOUR SCIENCE**

(BOOKLET A)

29 OCTOBER 2020

Total time for booklets A and B : 1 h 45 min

INSTRUCTIONS

Do not turn over this page until you are told to do so.

Follow all instructions carefully.

Answer all questions.

Name : _____ ()

Class : Primary 4 _____

Parent's Signature : _____

Booklet A	56
Booklet B	44
Total	100

Section A (28 x 2 marks)

For each question from 1 to 28, four options are given. One of them is the correct answer. Make your choice and shade the correct oval (1, 2, 3 or 4) on the Optical Answer Sheet.

1. Which of the following is not a reptile?

(1)



(2)

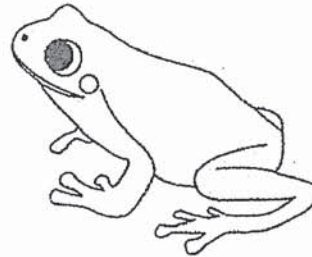

(3)

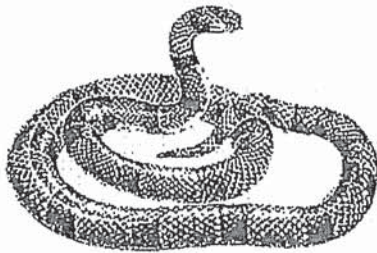

(4)

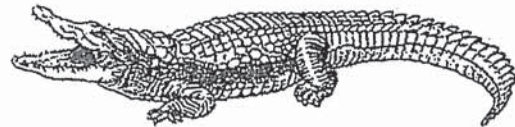

2. The arrows (→) in the diagram show how a substance moves in plants, starting from the roots of the plant.

roots → stem → leaves

What is this substance?

- (1) air
- (2) soil
- (3) food
- (4) water

3. Which animal has a 4-stage life cycle?

(1)

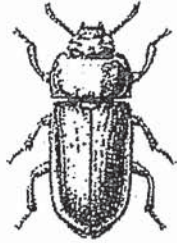

beetle

(2)

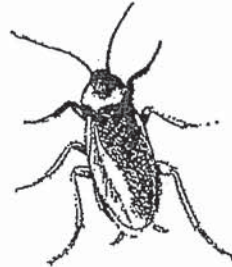

cockroach

(3)

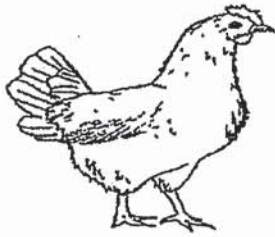

chicken

(4)



grasshopper

4. Which one of the following shows the correct order when food moves through some parts of the digestive system?

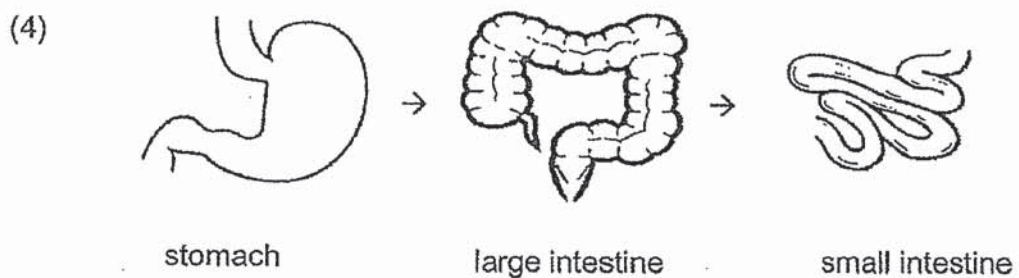
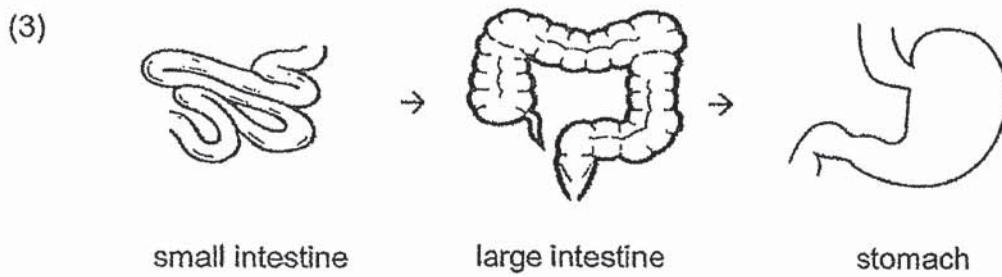
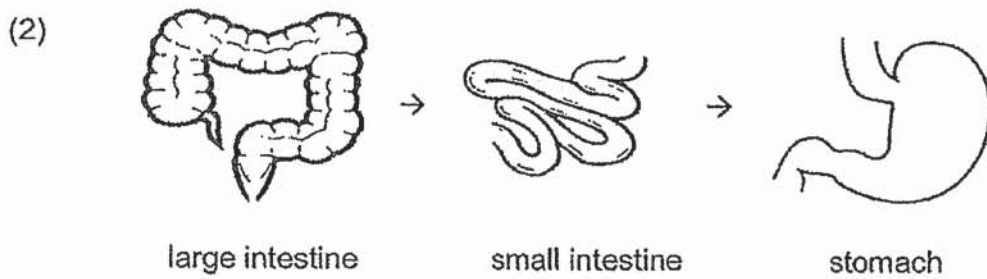
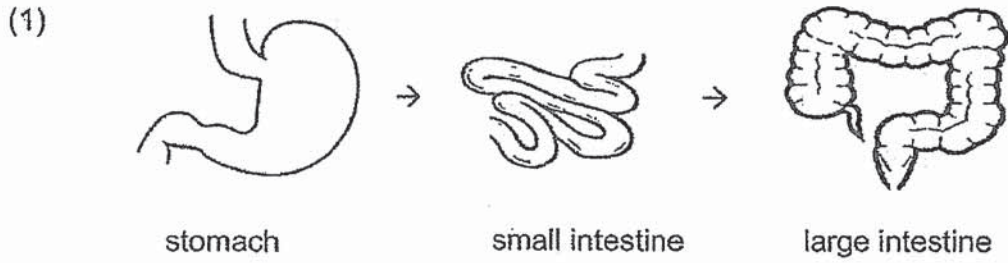

5. The diagram below shows a knife.

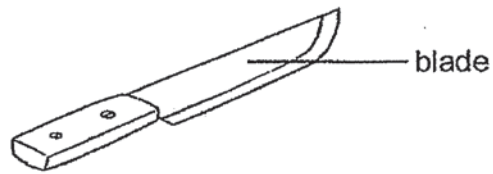

Metal is used to make the blade of the knife because metal _____.

- (1) can reflect light
 - (2) can float on water
 - (3) does not break easily
 - (4) does not allow light to pass through
6. Study the diagram below.

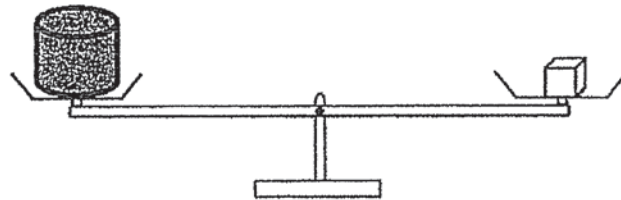

Which one of the following statements is true?

- (1) Both objects have the same size.
- (2) Both objects have the same mass.
- (3) Both objects have the same shape.
- (4) Both objects have the same volume.

7. The diagram shows a magnet brought near a plastic ball.

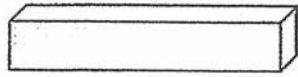

magnet



plastic ball

What will happen to the plastic ball?

- (1) It will spin.
 - (2) It will stay still.
 - (3) It will roll to the left.
 - (4) It will roll to the right.
8. Which one of the following is a source of light?

- (1) The moon



- (2) A mirror



- (3) A lighted matchstick



- (4) A shiny coin



9. Malcome wants to measure the temperature of hot water in a beaker. Which one of the following diagrams shows the correct position of the thermometer when taking temperature reading?

(1)

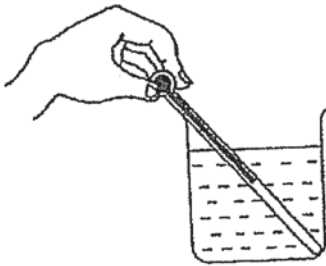

(2)

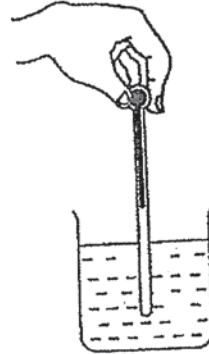

(3)

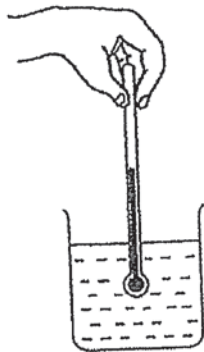

(4)

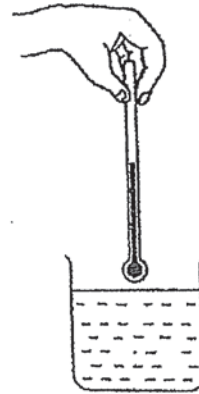

10. Which one of the following properties is true for both air and a balloon?

- (1) They can be seen.
- (2) They take up space.
- (3) They have fixed shapes.
- (4) They have fixed volumes.

11. Which one of the following is a characteristic of all fungi?

- (1) All fungi can be eaten.
- (2) All fungi reproduce by seeds.
- (3) All fungi cannot make their own food.
- (4) All fungi can only be seen using a microscope.

12. Study the flowchart below.

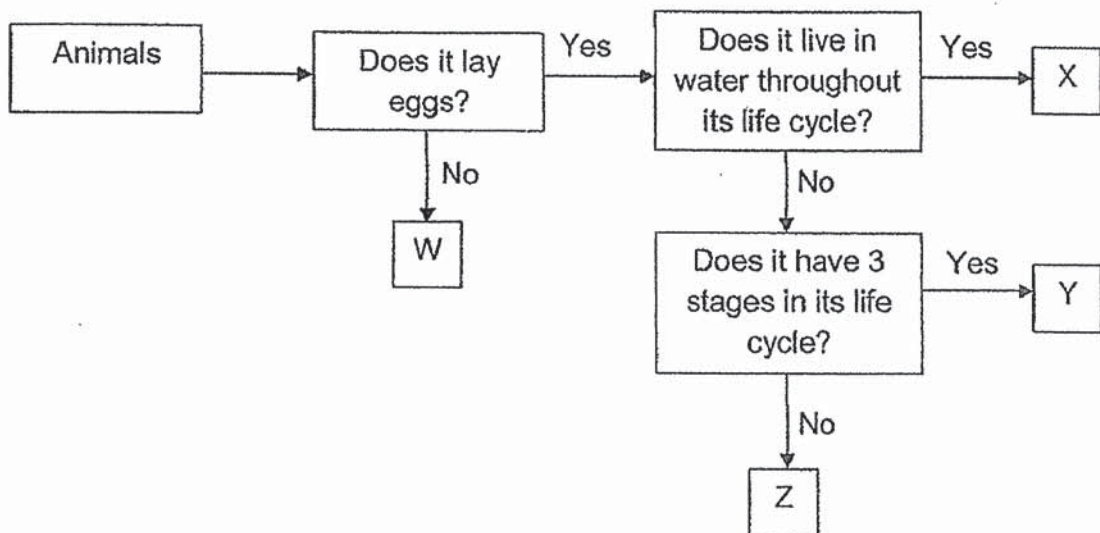

Based on the information given, which one of the following is true?

- (1) Animal X lay eggs but Animal Z does not.
- (2) Animals W and Z live in water throughout their life cycle.
- (3) Animal Z has a 3-stage life cycle but Animal Y does not.
- (4) Animal X lives in water throughout its life cycle but Animal Y does not.

13. The diagram below shows a water plant in a tank of water.

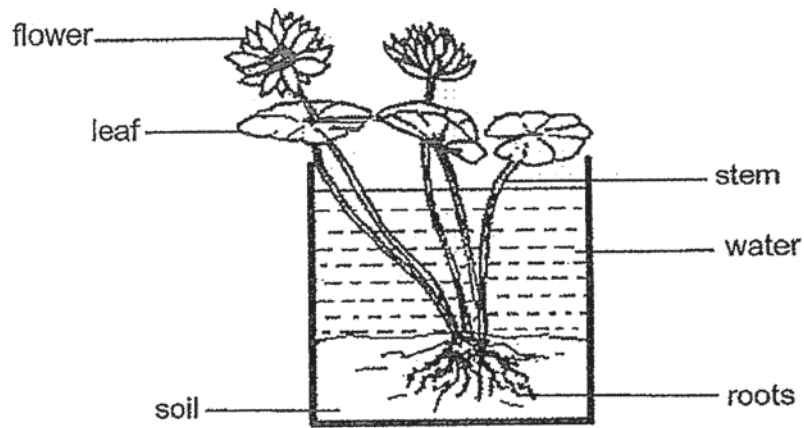

Which of the following plant part and the function is **not** correct for this plant?

	Plant part	Function of the plant part
(1)	Leaf	Takes in and gives out gases
(2)	Stem	Takes in water and minerals
(3)	Roots	Hold the plant to the soil
(4)	Flower	Develops into a fruit

14. The organs in the digestive system are represented by the letters P, Q, R, S and T. The graph below shows the amount of undigested food leaving each organ after a meal.

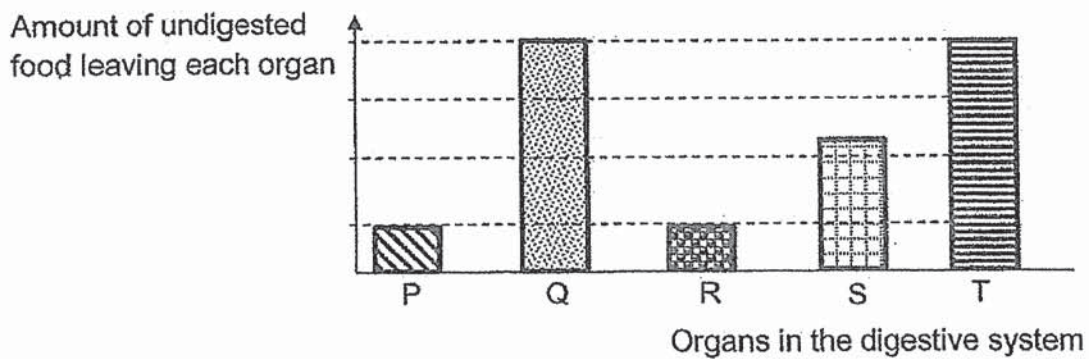

Based on the above graphs, which of the following is correct?

	Mouth	Gullet	Small intestine	Large intestine
(1)	P	R	Q	T
(2)	T	Q	S	P
(3)	Q	T	P	R
(4)	S	Q	R	P

15. The table below shows the properties of four materials, P, Q, R and S. A tick (✓) indicates that the object has that property.

Materials	Waterproof	Flexible	Strong
P	✓	✓	✓
Q	✓	✓	
R	✓		✓
S		✓	✓

Based on the table above, which material, P, Q, R or S, is most suitable to make a food tray that can be used in the food centre?

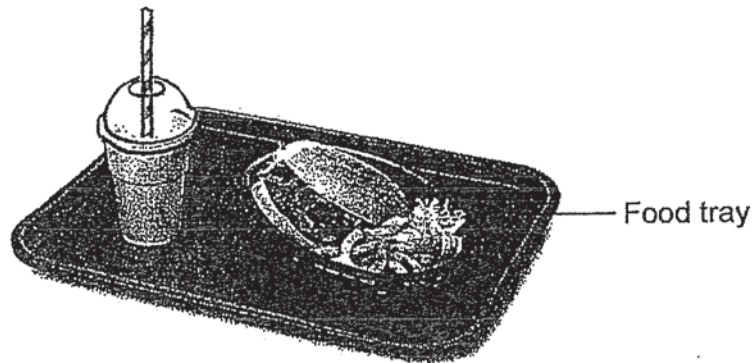

- (1) P
- (2) Q
- (3) R
- (4) S

16. Ming Hui used the set-up below to test the strength of four bags, A, B, C and D. The bags were of the same size but made of different materials. He put garden soil into the bags and increased the amount of soil in each bag until the bag broke.

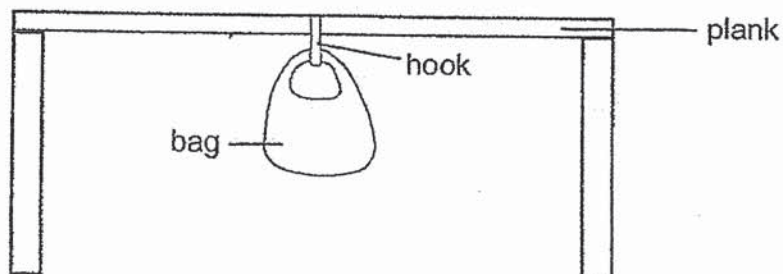

He recorded his results in the table below.

Bag	Amount of soil that caused the bag to break (g)
A	580
B	2500
C	2000
D	1220

Based on the results above, which bag is most suitable to be used to carry 2000g of rice?



- (1) A
- (2) B
- (3) C
- (4) D

17. Harry conducted an experiment using three different objects, W, X and Y. The container of water is filled up to the spout. As each object is placed into the container, some water flowed out from the spout and is collected in a beaker. The amount of water in the beaker was then measured and recorded.

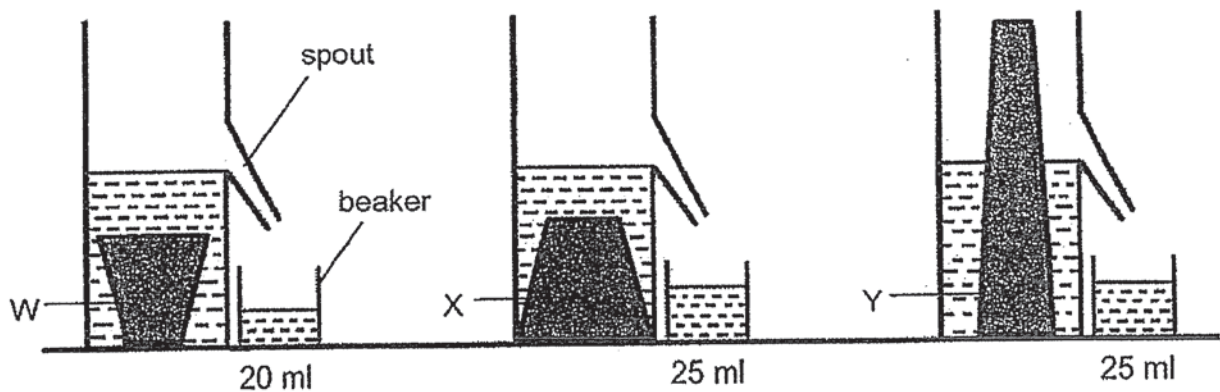

Which of the following can Harry conclude about the above objects W, X and Y?

- A Object Y has the greatest volume.
 - B Object X has a greater mass than W.
 - C Objects X and Y have the same volume.
 - D Object X has a greater volume than W.
- (1) A and D only
- (2) B and C only
- (3) C and D only
- (4) A, B, C and D

18. Which of the following are not matter?

- A Cloud
- B Ice cubes
- C Shadow of a tree
- D Sound of the school bell

- (1) A and B only
- (2) A and D only
- (3) B and C only
- (4) C and D only

19. Substance S changes directly from solid to gas at room temperature. Chun Li placed a piece of 50 cm^3 substance S into a box. The volume of the box is 500 cm^3 . She then sealed the box tightly and left it in a room until all the substance S disappeared.

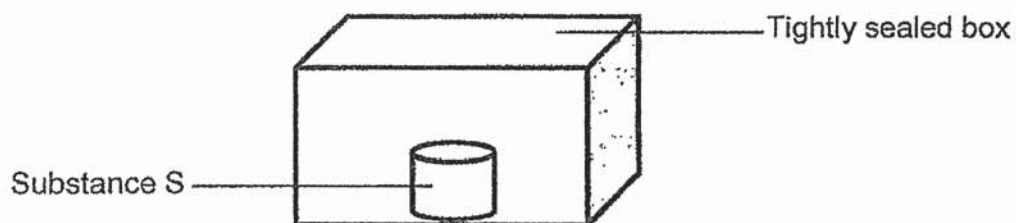

What is the final volume of air in the box after all of substance S has disappeared?

- (1) 50 cm^3
- (2) 450 cm^3
- (3) 500 cm^3
- (4) 550 cm^3

20. Study the set-up shown below.

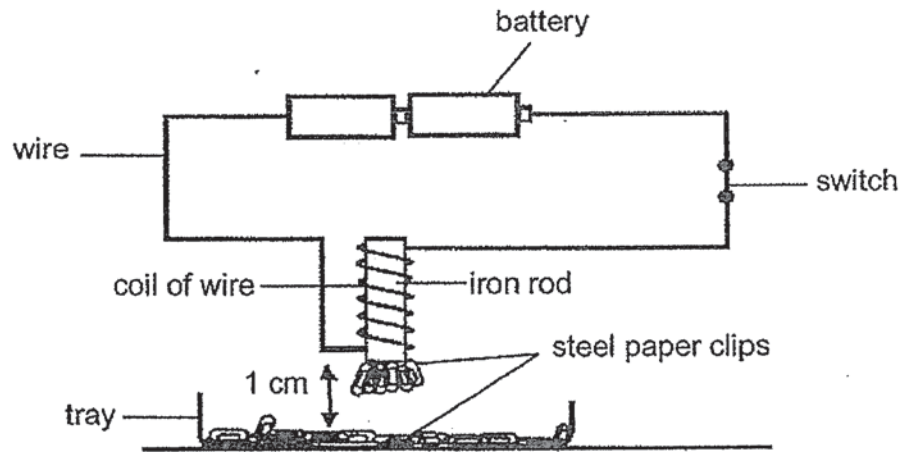

Which one of the following actions would increase the number of steel paper clips attracted to the electromagnet?

- (1) Put more steel paper clips in the tray.
- (2) Connect another battery to the circuit.
- (3) Coil less turns of wire around the iron rod.
- (4) Move the electromagnet further away from the tray.

21. Rick placed one end of a magnet close to a compass.



North pole of small magnet

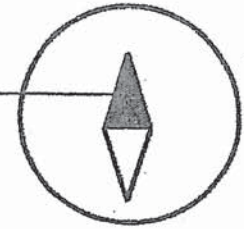

Which of the following observation(s) is/are possible?

Set-up	
A	
B	
C	
D	

- (1) A only
- (2) A and D only
- (3) B and C only
- (4) B, C and D only

22. The diagram below shows a way to separate a mixture of different objects made of various materials.

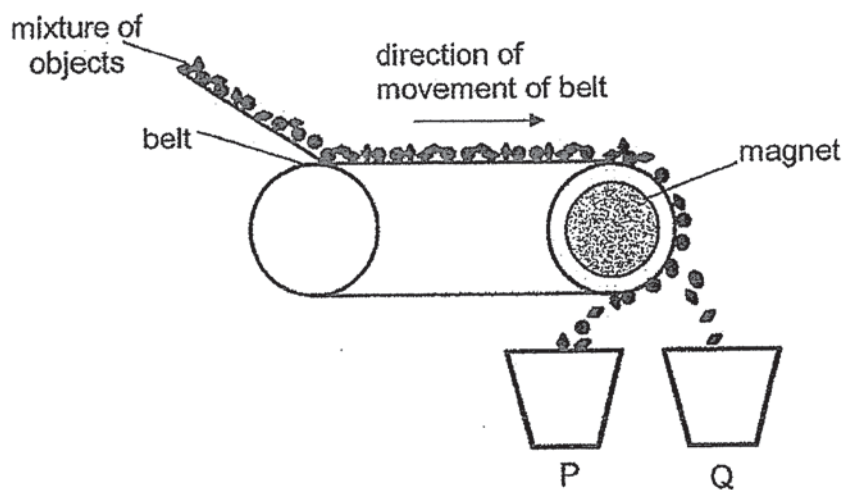

Which of the following shows the materials that can be found in P and Q?

	Container P	Container Q
(1)	iron nail	ice-cream stick, plastic straw
(2)	cotton wool, plastic straw	iron nail
(3)	ice-cream stick	cotton wool, copper coin
(4)	iron nail, copper coin	plastic straw, cotton wool

23. Dan carried out an investigation to find out which material is the best conductor of heat. He added the same amount of hot water at 90°C into each cup. He then measured the time taken for the hot water to cool down to 50°C .

How should Dan place the cups of hot water to ensure a fair test?

(1)

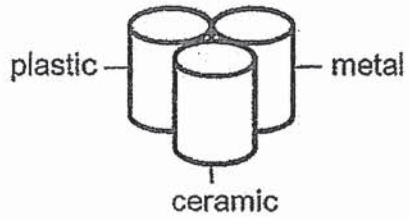

(2)

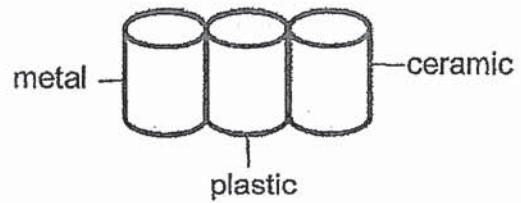

(3)

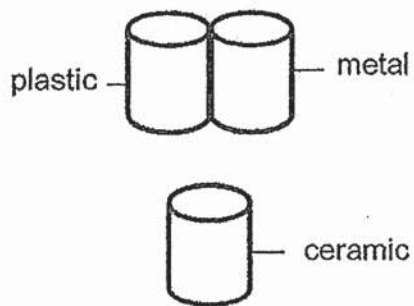

(4)

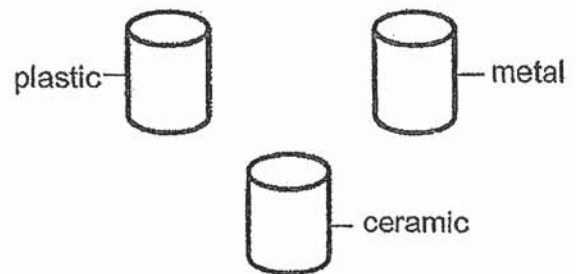

24. A group of students carried out an experiment with two similar rods, A and B, as shown below. At the start of the experiment, the rods were of the same length.

After 20 minutes, the length of each rod was measured and the results were recorded.

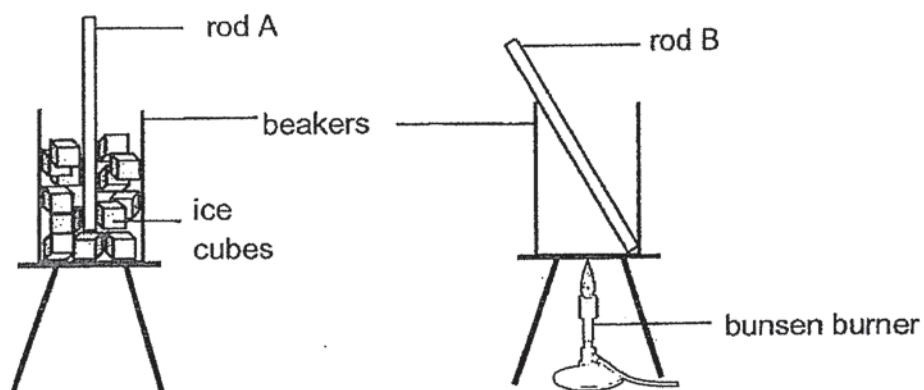

Which of the following shows the correct conclusion for this experiment?

- (1) Rod A lost heat and became longer.
- (2) Rod B gained heat and became longer.
- (3) Rod A gained coldness and became shorter.
- (4) Rod B lost heat to the surrounding and became shorter.

25. Andy made four similar boxes using different materials A, B, C and D. The temperature of the air inside the box at the beginning of the experiment was 25°C. He then left the boxes under the sun for one hour. He measured and recorded the temperature of air inside each box at the end of the experiment.

Material used	Temperature of air inside the box at the end of the experiment (°C)
A	30
B	35
C	28
D	39

Which one of the following materials would be most suitable for making a box to slow down ice cream from melting?

- (1) A
- (2) B
- (3) C
- (4) D

26. John was reading a book in his room as shown below.



Which of the following explain(s) why he was able to see the words on his book?

- A Light travels in a straight line.
 - B Light is given out by all objects.
 - C Light was reflected into John's eyes.
 - D Light cannot be reflected from the book.
-
- (1) A only
 - (2) B and D only
 - (3) A and C only
 - (4) B, C and D only

27. Hebe stood under a lamp as shown below.

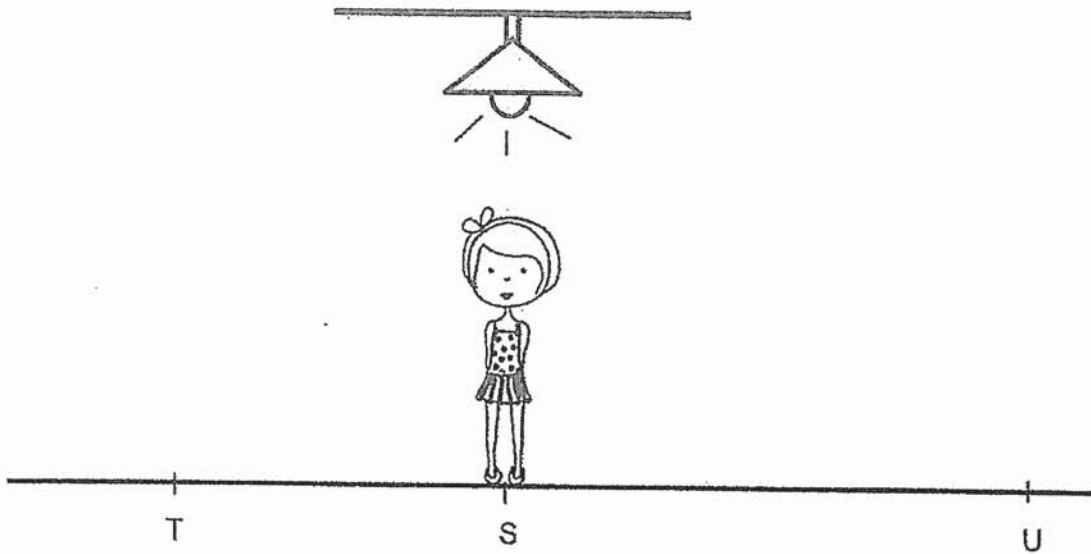

She walked from position S to position T, and then to position U in a straight line. Which graph shows how the length of her shadow changed during this time?

(1)

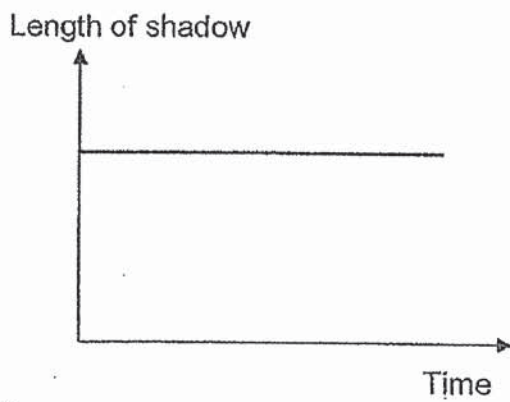

(2)

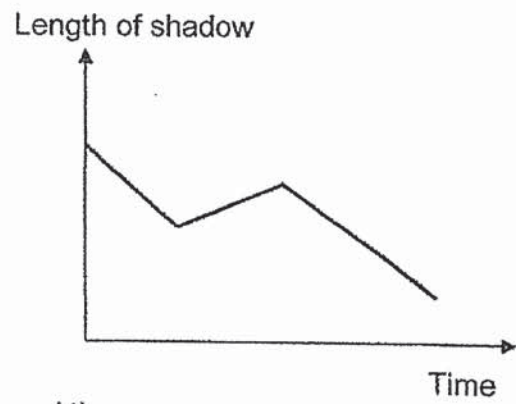

(3)

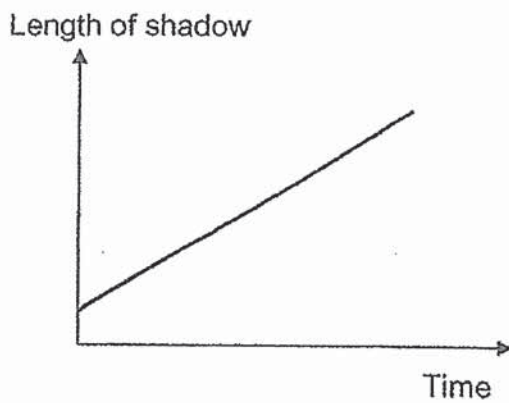

(4)

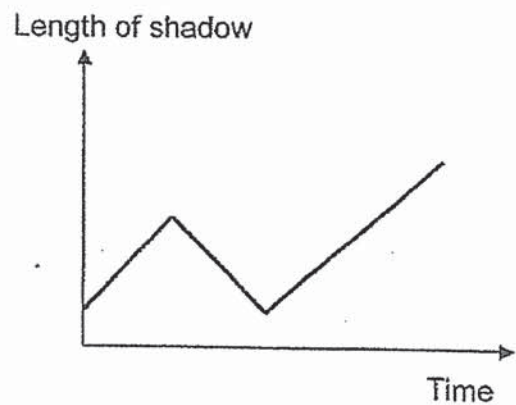

28. Sam had three objects, S, T and U, which were made of different materials.

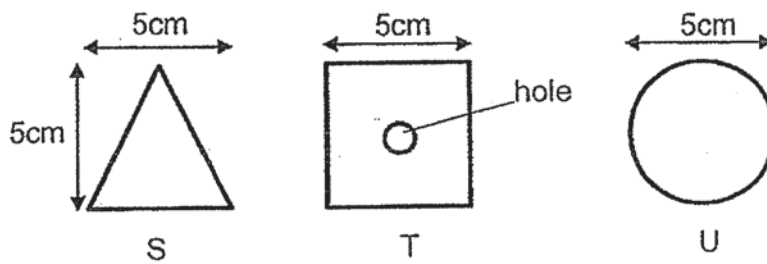

He arranged the objects in a set-up as shown below.

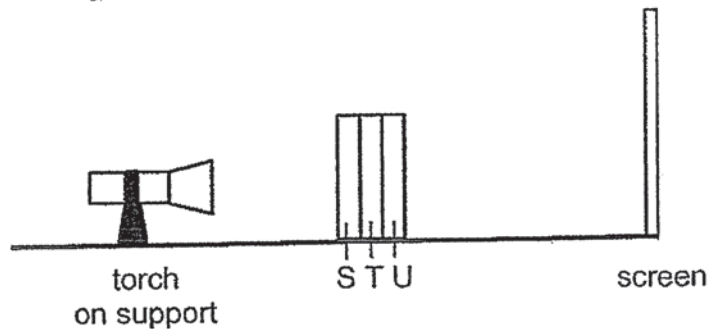

When he switched on the torch in a dark room, he observed the following shadow cast on the screen.

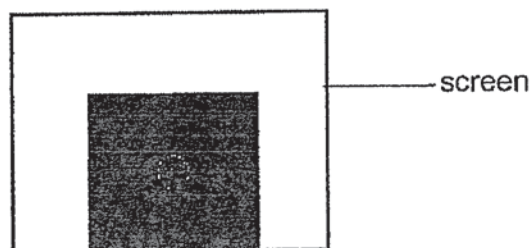

Which one of the following represents the properties of the materials for objects S, T and U?

	S	T	U
(1)	Does not allow light to pass through	Does not allow light to pass through	Allows most light to pass through
(2)	Does not allow light to pass through	Allows most light to pass through	Does not allow light to pass through
(3)	Allows most light to pass through	Does not allow light to pass through	Allows some light to pass through
(4)	Allows some light to pass through	Does not allow light to pass through	Does not allow light to pass through

End of Booklet A



AI TONG SCHOOL

**2020 END-OF-YEAR EXAMINATION
PRIMARY FOUR SCIENCE**

(BOOKLET B)

29 OCTOBER 2020

Total time for booklets A and B : 1 h 45 min

INSTRUCTIONS

Do not turn over this page until you are told to do so.

Follow all instructions carefully.

Answer all questions.

Write your answers in this booklet.

Name : _____ ()

Class : Primary 4 _____

Parent's Signature : _____

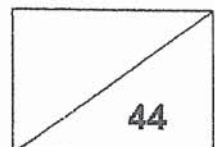

Section B: 44 marks

Read the questions carefully and write down your answers in the spaces provided.

29. Draw lines to match the following animals to the correct groups. [3]

Animals

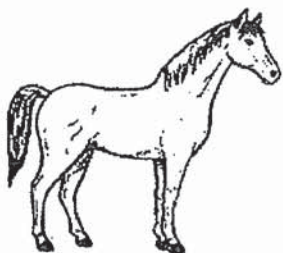

•



•

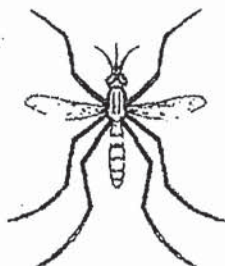

•

Groups

• mammal

• insect

• fish

• bird

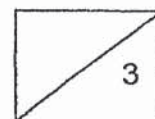

30. The diagram below shows different stages (X, Y and Z) in the growth of a young plant.

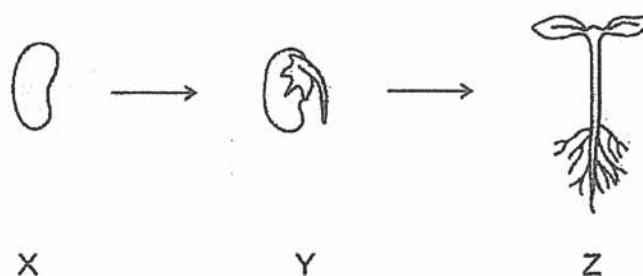

Fill in the blanks using the correct letters or words given in the box below.

X	Y	Z
roots	stem	leaves

The plant at stage _____ can make its own food because it has _____

[2]

31. The picture below shows a cup of hot tea.



Circle the correct state for the following things.

(a) The tea is a (solid / liquid / gas). [1]

(b) The cup is a (solid / liquid / gas). [1]

32. The diagram below shows an aquarium in Jon's house.

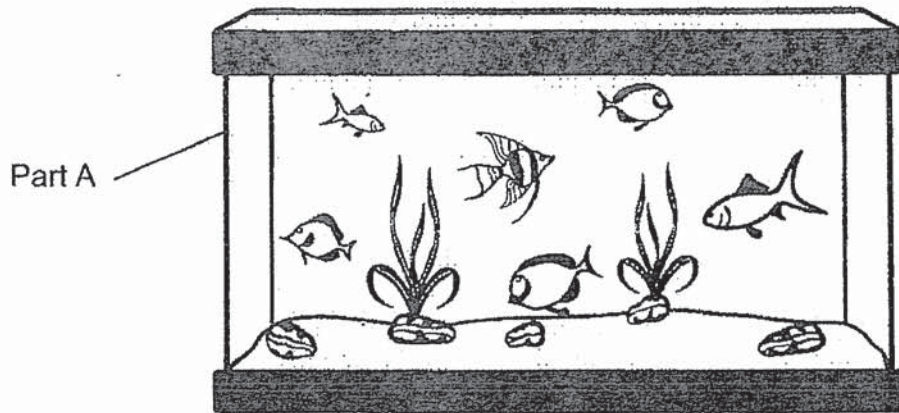

Fill in the blanks using the correct words given in the box below.

light	gain	lose
heat	bends	breaks

- (a) Part A is made of glass because it allows _____ to pass through so that Jon can see the fish in it. [1]
- (b) Jon has to be careful when he cleans the aquarium because part A _____ easily when dropped. [1]
- (c) When the aquarium is placed near the window, the sun shines on it. This causes the water to _____ heat. [1]

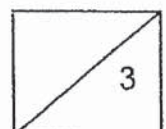

33. The diagram below shows the life cycle of a butterfly.

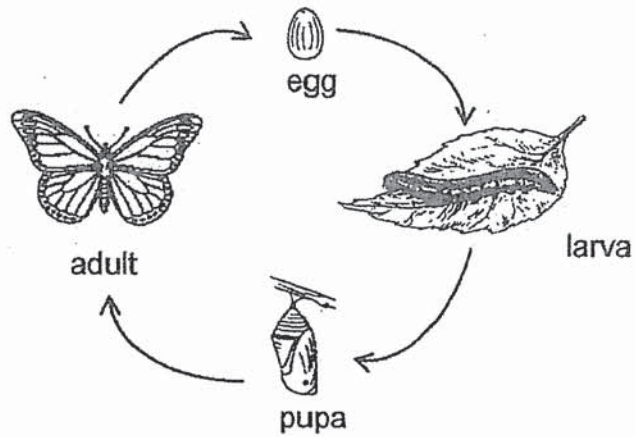

(a) Why is it important for living things to have an adult stage in their life cycle? [1]

(b) State two differences between the larva stage and the pupa stage of a butterfly. [2]

Difference 1: _____

Difference 2: _____

(c) At which stage of the life cycle is the butterfly a pest to farmers? Give a reason for your answer. [1]

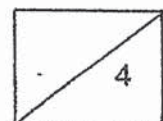

34. Gary wanted to find out if the number of leaves a plant has affects its growth. He used two similar plants, A and B. Plant A had all its leaves while plant B had most of its leaves removed.

He watered the two plants daily with the same amount of water and placed them next to each other in the garden as shown in the set-up below.

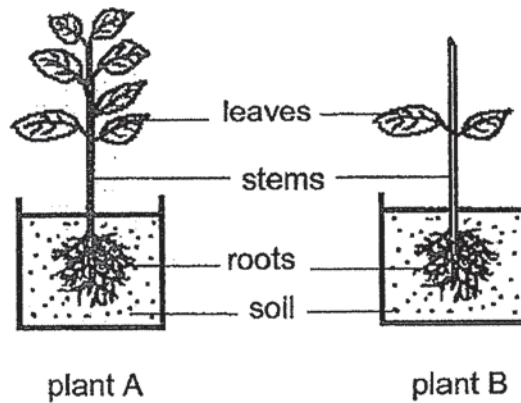

After a few weeks, Gary observed that plant A grew taller than plant B.

(a) Explain why plant A was able to grow taller than plant B. [1]

(b) Do you think Gary's experiment is a fair one? Explain your answer. [1]

35. The table below shows parts of the human digestive system and their functions.

Parts of the human digestive system	Function	
	Digestion of food takes place	Digested food is absorbed into the bloodstream
P	Yes	No
Q	Yes	Yes

(a) Which organs do parts P and Q represent? [2]

Part P : _____

Part Q : _____

Due to some medical conditions, a patient had to undergo surgery to cut away a part of his large intestine.

The diagram below shows the large intestine before and after the surgery.

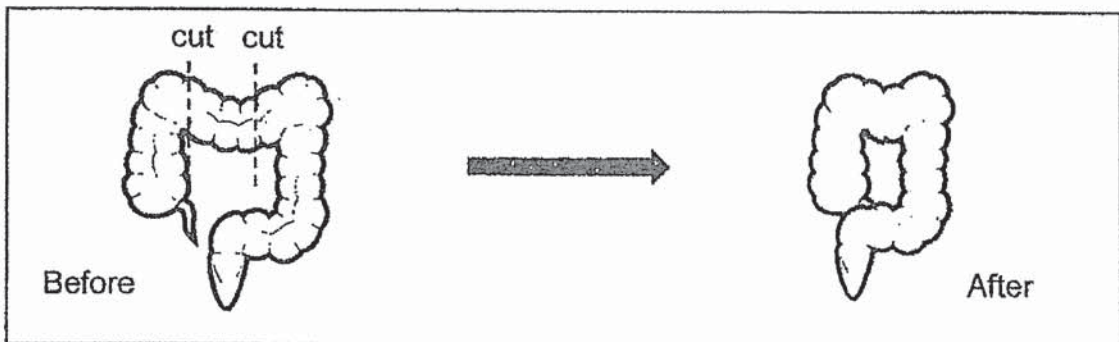

The shortening of the large intestine affects the amount of its surface area.

(b) State what you think will happen to the waste that is passed out from the patient's body. Explain your answer. [2]

36. Karen wanted to cool down a bottle of water quickly. She placed the bottle of water on top of a block of ice as shown below in diagram 1.

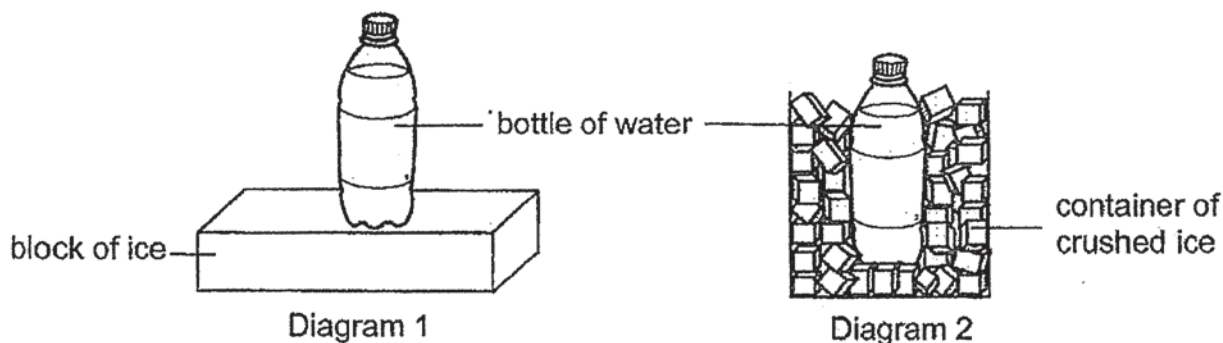

Karen's mother told her that she should crush up the block of ice and put the bottle of water into the crushed ice to cool it faster, as shown in diagram 2.

- (a) Do you agree with Karen's mother? Give a reason for your answer. [2]

- (b) Karen then poured 100 ml of cold water from the bottle into two different cups. The cups are made of metal and styrofoam. Karen realised that the water in the metal cup is warmer than the water in the styrofoam cup after 10 minutes. Explain why this happens. [2]

37. Adam poured 300 cm^3 of sand from container X into container Y as shown in the diagram below.

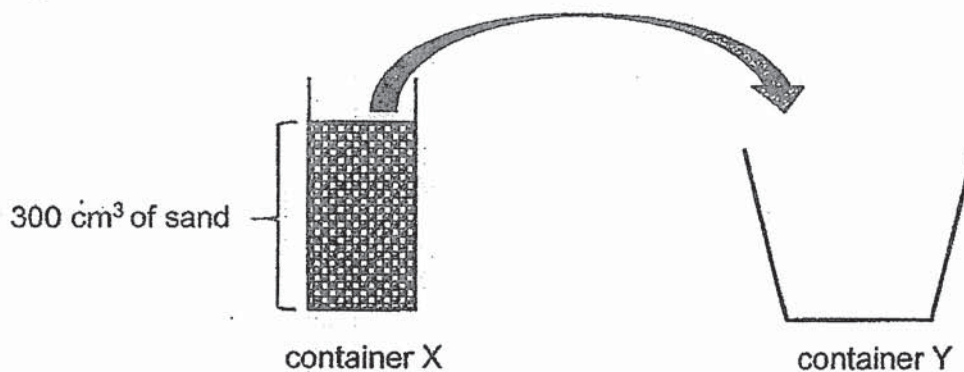

- (a) Adam observed that the volume of sand does not change after pouring into a bigger container Y. State a property of sand based on Adam's observation. [1]

- (b) Adam also observed that the sand took the shape of container Y. He concluded that sand is in the liquid state. Using the properties of matter, explain why Adam is wrong. [1]

Adam then poured 200 cm^3 of water into container Y as shown below. He observed some bubbles escaping from the sand.

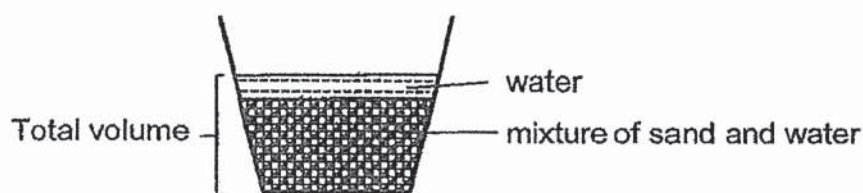

- (c) Will the total volume of sand and water be equal to 500 cm^3 , more than 500 cm^3 or less than 500 cm^3 ? Explain your answer. [2]

38. The diagram below shows how Carl used a magnet to stroke an iron bar Z to make it into a temporary magnet.

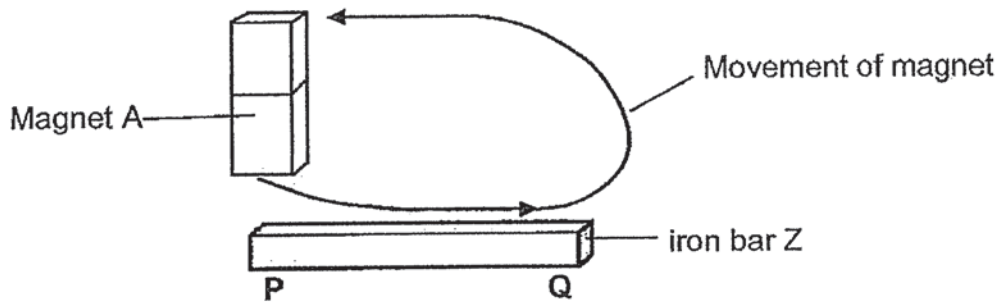

(a) What should Carl do if he wants to increase the magnetic strength of iron bar Z? [1]

Next, Carl conducted an experiment to find out if the magnetic strength of bar magnets increases with size. He hung three magnets, A, B, C, and the magnetised iron bar Z at the different distances away from similar plastic trays filled with equal number of paper clips. The result of his experiment is shown below.

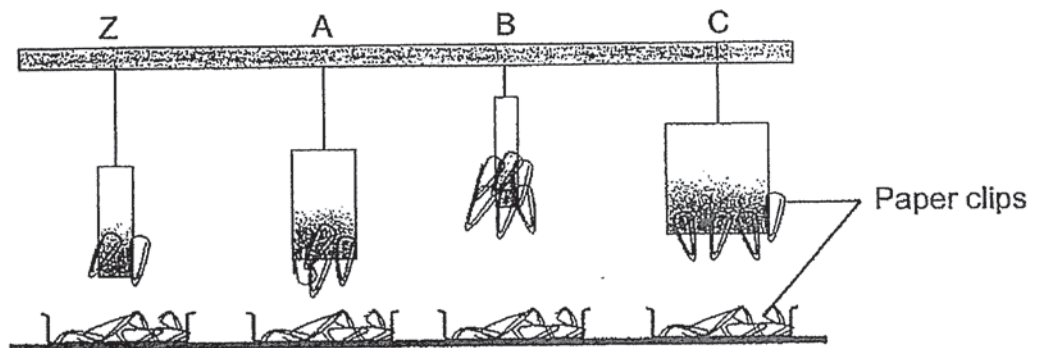

(b) Carl thinks that the magnetised iron bar Z is the weakest magnet. Do you agree with him? Explain why. [2]

(c) What can Carl conclude about the size of magnets and the number of paper clips attracted? [1]

39. Mr Huang conducted the experiment below in a dark room.

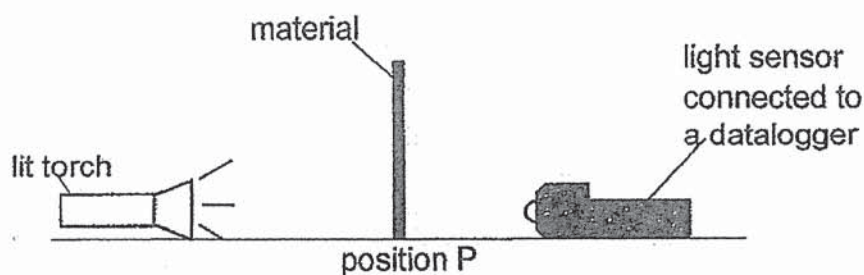

He observed that when no material was placed at position P, the amount of light detected by the light sensor was 2000 units.

He then placed materials X, Y and Z at position P, one at a time. He recorded the amount of light detected by the light sensor in the table below.

Materials	Amount of light detected (units)
X	1800
Y	0
Z	900

(a) What is the measured variable in Mr Huang's experiment? [1]

(b) State a property of material Z. [1]

(c) What will happen to the amount of light detected if the torch is moved further away from the light sensor? [1]

Question 39(d) continues on the next page.

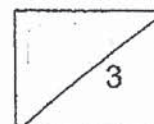

- (d) Mr Huang wants to make a treasure chest as shown in the diagram below. Based on his results, which material, X, Y or Z, is most suitable to make part A of the treasure chest so that no one can see his treasures in the box? Explain your choice. [1]

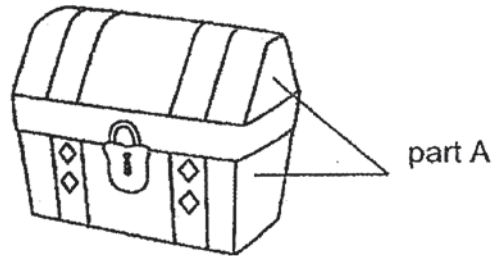

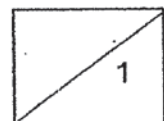

40. Jake conducted an experiment shown below. An iron nail was hung at the same distance from the two iron bars.

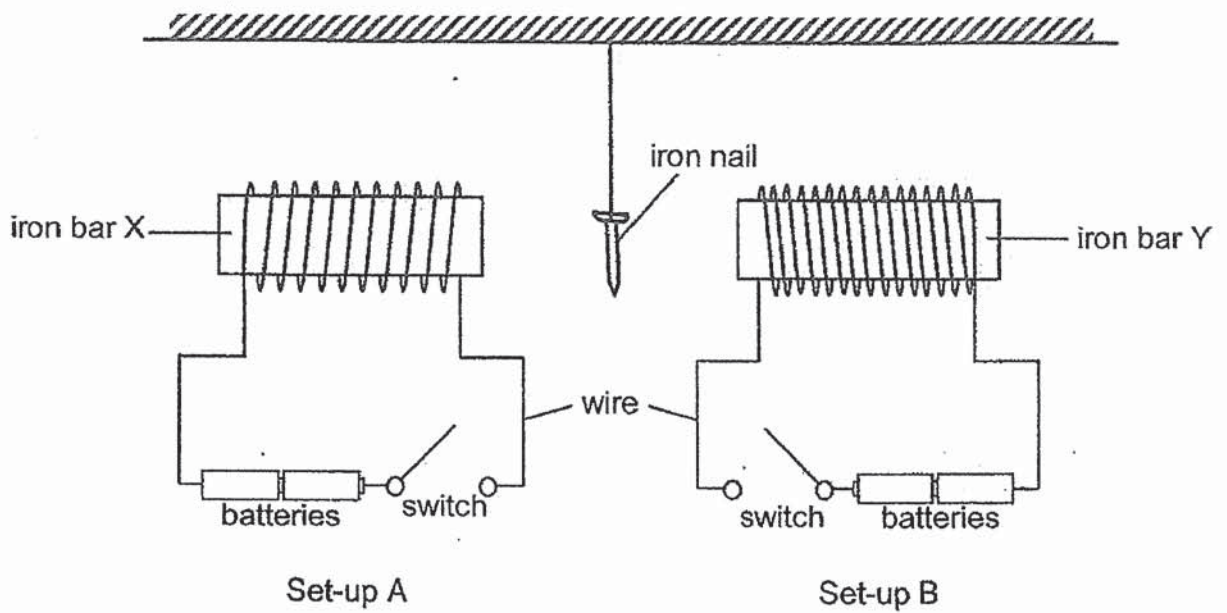

- (a) State what Jake would observe when he turned on the switches in both set-ups A and B at the same time. Explain his observation. [2]

Question 40(b) continues on the next page.

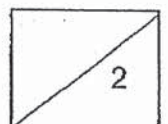

40. Next, Jake removed set-up A and replaced the iron nail with object Z.

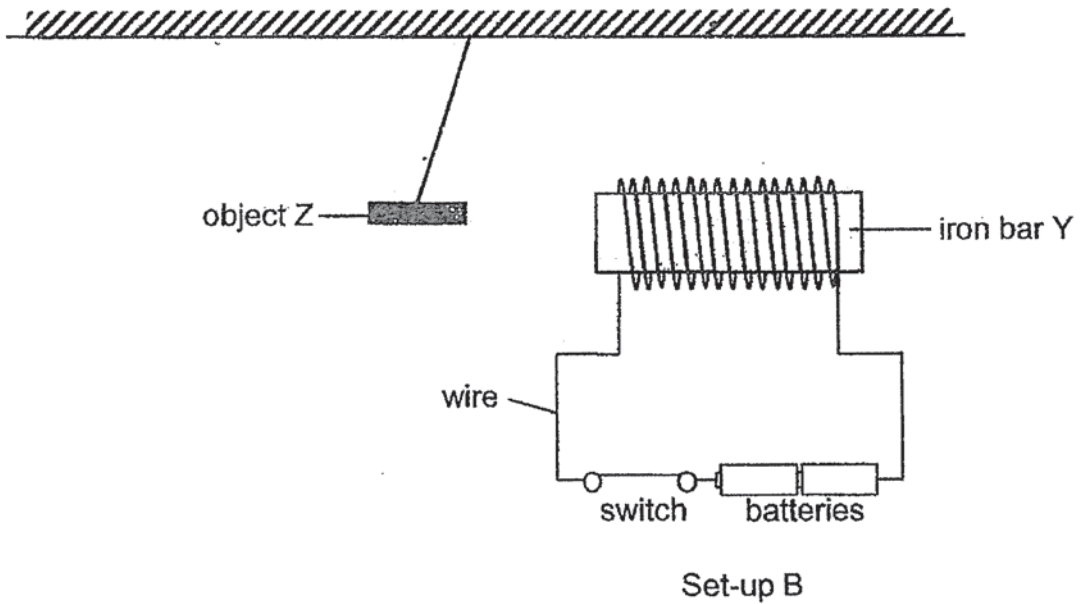

- (b) When the switch in set-up B was turned on, object Z moved away from Y. Based on his observations, what could object Z be? Explain your answer. [2]

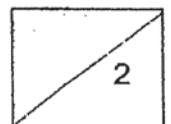

41. The diagram shows the layout of a stage for a shadow puppet show.

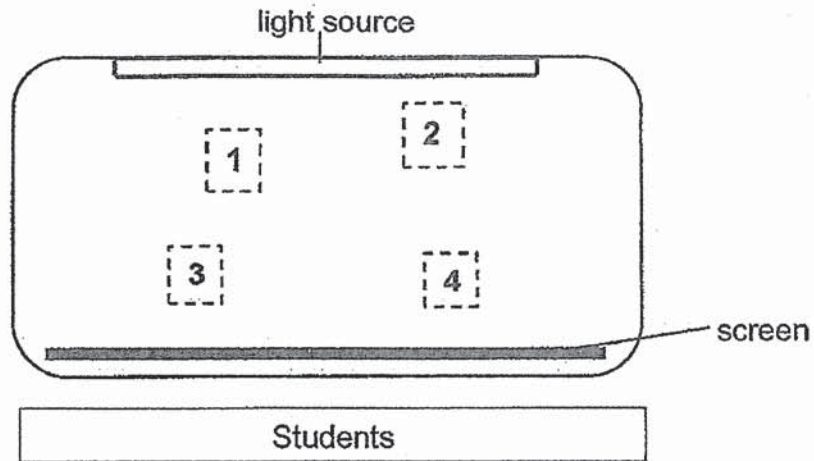

During the show, two puppets of identical shape and size were used. The students watching the puppet show saw two shadows on the screen as shown below.



(a) In order to form the above shadows, at which positions 1, 2, 3 or 4 were the puppets placed? [2]

(i) Position of puppet A: _____

(ii) Position of puppet B: _____

(b) Give a reason for your answer in (a)(i). [1]

(c) State a property of light that enables a shadow to be formed. [1]

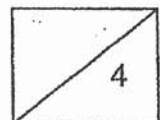

ANSWER KEY

YEAR : 2020
LEVEL : PRIMARY 4
SCHOOL : AI TONG
SUBJECT : SCIENCE
TERM : SA2

BOOKLET A

Q1	2	Q2	4	Q3	1	Q4	1
Q5	3	Q6	2	Q7	2	Q8	3
Q9	3	Q10	2	Q11	3	Q12	4
Q13	2	Q14	3	Q15	3	Q16	2
Q17	1	Q18	4	Q19	3	Q20	2
Q21	2	Q22	1	Q23	4	Q24	2
Q25	3	Q26	3	Q27	4	Q28	3

BOOKLET B

Q29	Horse – Mammal Eagle – Bird Mosquito – Insect
Q30	The plant at Stage Z can make its own food because it has leaves.
Q31	Tea is a Liquid Cup is a solid
Q32	a) Light b) Breaks c) Gain
Q33	a) Only adults can reproduce or produce young. b) Difference 1 : The larva eat a lot but the pupa does not eat. Difference 2 : The larva moults but the pupa does not moult. c) The larva stage because larva eat leaves.
Q34	a) Plant A has more leaves so it is able to make more food and grow taller. b) Yes , There is only one changed variable which is the number of leaves.

Q35	<p>a) Part P : mouth or stomach Part Q : small intestine</p> <p>b) The waste would have more water. There is less surface area of the large intestine to absorb less water.</p>
Q36	<p>a) The crushed ice have more exposed surface area. There is an increase in the contact surface area between the ice and the bottle of water, more heat from the water can be transferred to the ice.</p> <p>b) Metal is a better conductor of heat than Styrofoam. Heat is transferred faster from the surroundings to the water in metal cup.</p>
Q37	<p>a) Sand has a definite volume.</p> <p>b) Sand is a solid and have a definite shape.</p> <p>c) Less than 500cm³. There is air space's between the sand, Water will take up the space previously occupied by air.</p>
Q38	<p>a) Stroke the iron bar more times.</p> <p>b) Yes . It is the closet to the tray of paper clips, but it attracted the least number of paper clips.</p> <p>c) The size of the magnet does not affect the number of paper clips it attracts.</p>
Q39	<p>a) The amount of light that passes through the materials.</p> <p>b) Material Z is translasent.</p> <p>c) The amount of light detected will decrease.</p> <p>d) Y , because no light is detected by the datalogger when light was shone through material Y.</p>
Q40	<p>a) Iron nail is attracted to iron bar y. The iron bar y has more coils of wire around it, so it is a stronger electromagnet.</p> <p>b) Object Z is a magnet. Only magnet can be repelled by another magnet when their like poles are facing each other.</p>
Q41	<p>a) Position of puppet A : 1 Position of puppet B : 4</p> <p>b) Position 1 is nearer to the light source so the shadow formed will be bigger.</p> <p>c) Light can be blocked.</p>