



**Anglo-Chinese School
(Primary)**

A Methodist Institution
(Founded 1886)

**SEMESTRAL ASSESSMENT TWO 2020
SCIENCE
PRIMARY FOUR
BOOKLET A**

Name: _____ ()

Class: Primary 4 _____

Date: 28 October 2020

Total Time for Booklets A and B: 1 h 45 min

Additional Materials: Optical Answer Sheet (OAS)

INSTRUCTIONS TO CANDIDATES

1. Write your name, index number and class in the spaces provided.
2. Do not turn over this page until you are told to do so.
3. Follow all instructions carefully.
4. Answer all questions.
5. Shade your answer on the Optical Answer Sheet (OAS) provided.

This question paper consists of 17 printed pages including this cover page:

For each question from 1 to 28, four options are given. One of them is the correct answer. Make your choice (1, 2, 3 or 4) and shade your answer on the Optical Answer Sheet.

(56 marks)

- 1 A snail hides itself in its shell when touched.



This shows that the snail is a living thing because it _____.

- (1) breathes
 - (2) needs food
 - (3) can respond
 - (4) can reproduce
- 2 Which part, (1), (2), (3) or (4), holds the plant upright?

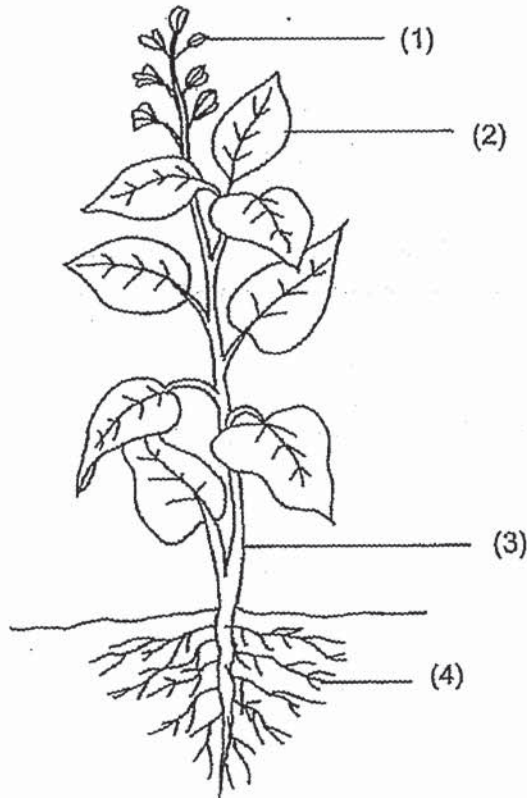

(Go on to the next page)

- 3 The arrows (→) in the diagram show the direction of movement of a substance in plants.

roots → stem → leaves

What is this substance?

- (1) water
 - (2) food
 - (3) soil
 - (4) air
- 4 Which animal has a pupa as a stage in its life cycle?
- (1) frog
 - (2) beetle
 - (3) chicken
 - (4) grasshopper
- 5 The diagram shows a pair of scissors.

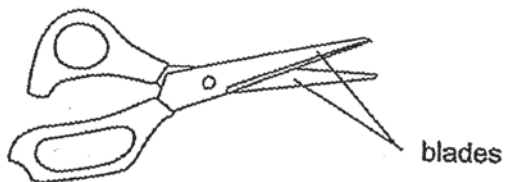

Metal is used to make the blades of the scissors because metal _____.

- (1) is shiny
- (2) can block light
- (3) does not break easily
- (4) can bend without breaking

(Go on to the next page)

6 Which of the following substances has a fixed shape?

- (1) air
- (2) milk
- (3) oil
- (4) rock

7 In which of the following will the two magnets push each other away?

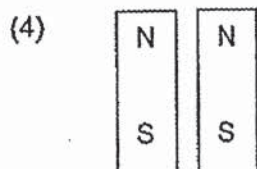
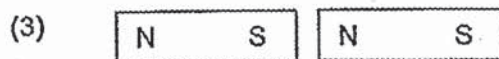
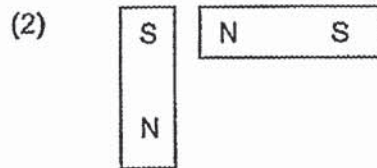
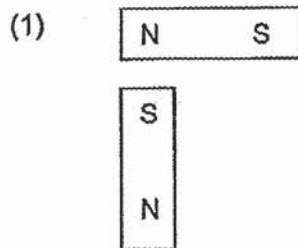

(Go on to the next page)

8 Which of the following is a source of light?

(1)



the moon

(2)



burning log

(3)



a leaf

(4)



a mirror

9 Which of the following is **NOT** a source of heat?

- (1) The Sun
- (2) A lighted bulb
- (3) A candle flame
- (4) A woollen sweater

(Go on to the next page)

10 Which one of the following is the best conductor of heat?

- (1) A metal plate
- (2) A paper plate
- (3) A plastic plate
- (4) A wooden plate

11 Jane made the following statements on the young of animal P.

- Young of animal P:
- breathes using gills
 - does not look like the adult

Based on the observations, animal P is most likely to be a _____.

- (1) frog
- (2) whale
- (3) beetle
- (4) butterfly

12 Ai Mei recorded some information about the life cycle of a butterfly and a chicken.

		Butterfly	Chicken
A	Lays eggs in water	No	No
B	Has 4 stages in its life cycle	Yes	Yes
C	The young resembles the adult	No	Yes

Which of the following options shows the correct information about the two life cycles?

- (1) A only
- (2) A and C only
- (3) B and C only
- (4) A, B and C

(Go on to the next page)

- 13 Richard noticed that the number of caterpillars in his garden decreased after two weeks. He wrote down some reasons for this observation.

- A The caterpillars have died.
- B The caterpillars have laid eggs.
- C The caterpillars have turned into pupae.
- D The caterpillars have been eaten by other animals.

Which of the following are possible reasons to explain why the number of caterpillars decreased?

- (1) A and B only
 - (2) B and C only
 - (3) C and D only
 - (4) A, C and D only
- 14 The bar graph shows the stages and the number of days that animal Z remains at each stage of its life cycle.

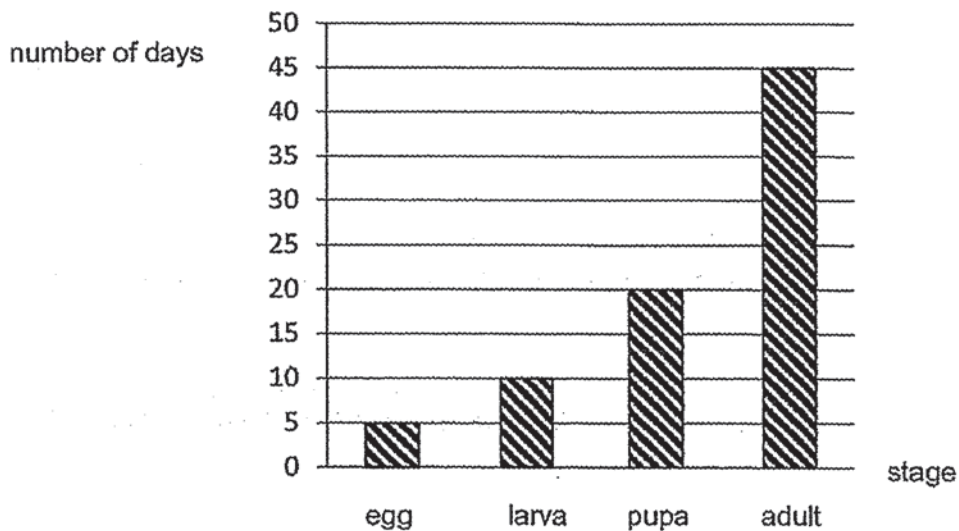

How many days does it take for animal Z to become an adult after hatching from its egg?

- (1) 10
- (2) 30
- (3) 35
- (4) 75

(Go on to the next page)

- 15 John wanted to find out the magnetic strength of four different magnets Q, R, S and T. He moved an iron nail slowly towards magnet Q and measured the distance when the nail was just attracted by the magnet. He repeated this experiment with magnets R, S and T. The results are shown in the diagram.

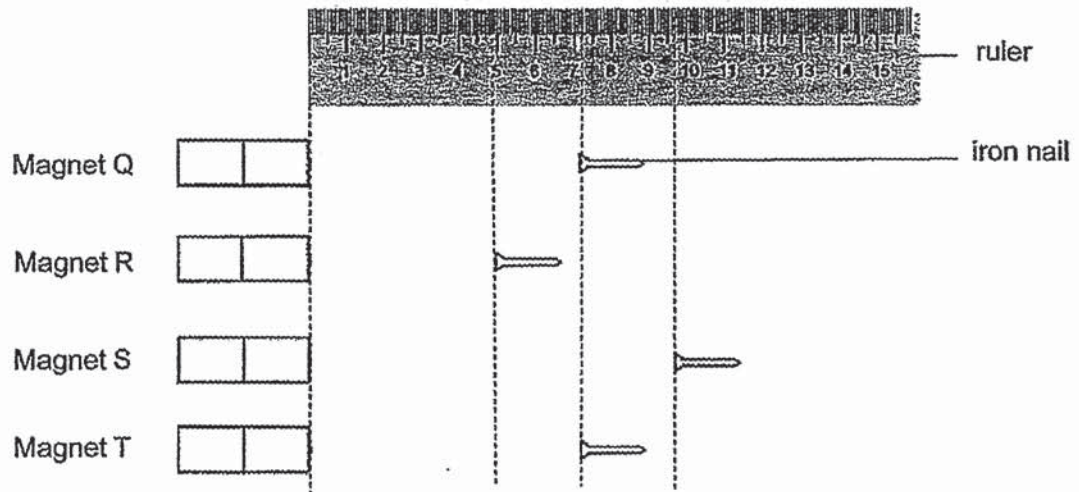

Based on the above results, the magnetic strength of _____.

- (1) Magnet S is the greatest.
- (2) Magnets Q and R is the same.
- (3) Magnet Q is lesser than Magnet R.
- (4) Magnet T is greater than Magnet S.

(Go on to the next page)

- 16 Two objects X and Y are placed on a balance as shown.

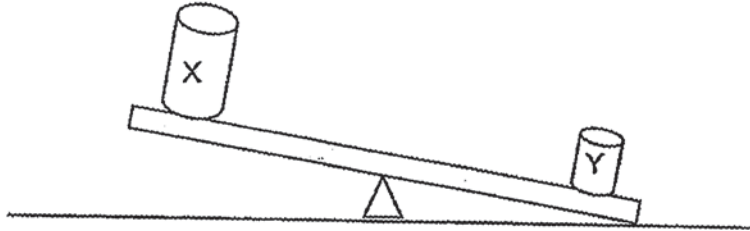

Based on the diagram, which of the following statements is correct?

- (1) Object Y has less mass than object X.
 - (2) Object Y has more mass than object X.
 - (3) Object Y has a bigger volume than object X.
 - (4) Objects X and Y are made of the same material.
- 17 George fills up a long balloon with air and twists it to form a 'balloon animal' as shown.

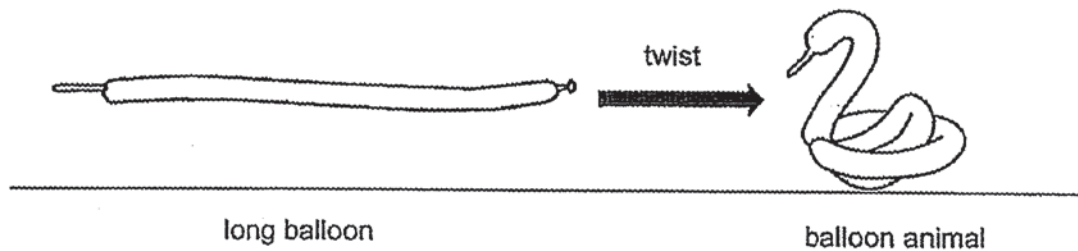

Which of the following statements best explains why he is able to twist the long balloon into a 'balloon animal'?

- (1) Air has mass.
- (2) Air occupies space.
- (3) Air does not have a definite shape.
- (4) Air does not have a definite volume.

(Go on to the next page)

- 18 Leela wanted to find the volume of her toy animal using the beaker shown.

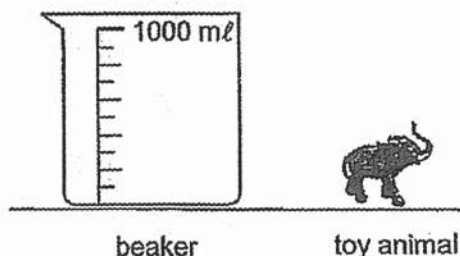

The following are the steps that she took to find the volume of the toy animal.

- A Read the new volume of water.
- B Fill the beaker with 500 ml of water.
- C Lower the toy animal gently into the beaker.
- D Calculate the difference between the old and new volume.

Which of the following shows the correct sequence of steps she took to find out the volume of the toy animal?

- (1) A, B, C and D
 - (2) B, A, C and D
 - (3) B, C, A and D
 - (4) C, B, A and D
- 19 All recorded the properties of P, Q and R as shown.

	Does it have mass and volume?	Does it have a definite shape?	Does it have a definite volume?	Can it be compressed?
P	No	No	No	No
Q	Yes	Yes	Yes	No
R	Yes	No	No	Yes

Based on the table above, which of the following correctly identifies P, Q and R?

	P	Q	R
(1)	Balloon	Pen	Sponge
(2)	Light	Pen	Air
(3)	Air	Milk	Pen
(4)	Heat	Pen	Milk

(Go on to the next page)

- 20 At the start of her experiment, Jane had a container that contains three substances A, B and C as shown. Then, she added more of substance B into the container using the one-way pump. The final levels of substances A, B and C at the end of the experiment are shown in the diagrams.

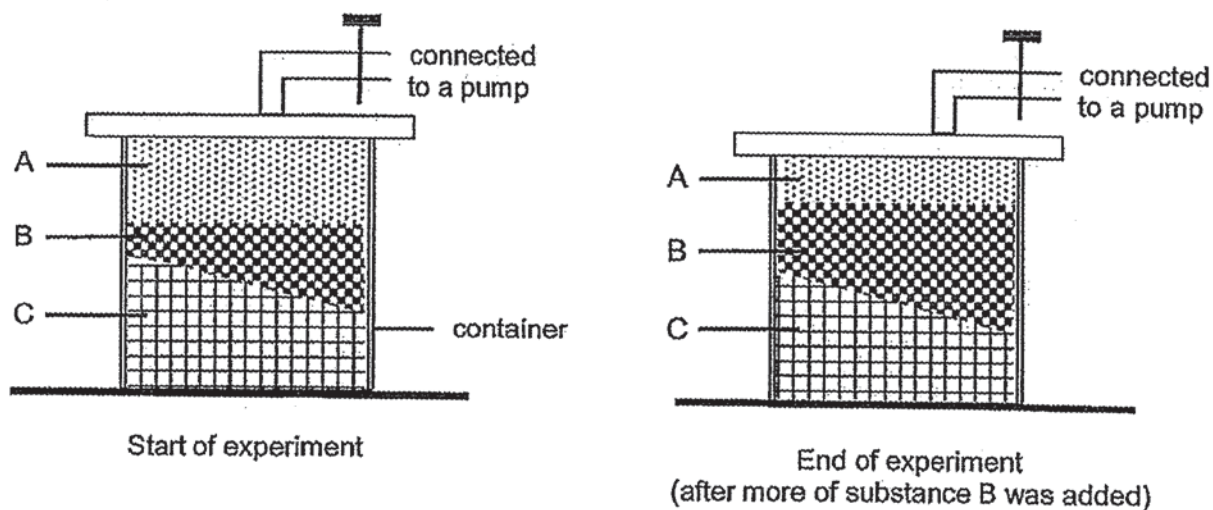

Based on the diagrams above, which of the following correctly identifies the state of substances A, B and C?

	A	B	C
(1)	Gas	Liquid	Solid
(2)	Liquid	Solid	Gas
(3)	Liquid	Gas	Solid
(4)	Gas	Solid	Liquid

(Go on to the next page)

- 21 James is able to see an object in a brightly-lit room. The arrows (\longrightarrow) in the diagram show the paths of light.

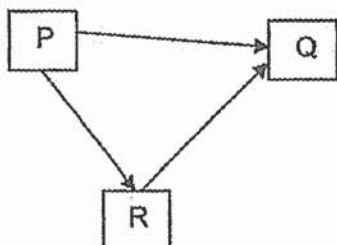

Which of the following identifies P, Q and R correctly?

	P	Q	R
(1)	light source	James' eyes	object
(2)	James' eyes	light source	object
(3)	light source	object	James' eyes
(4)	object	James' eyes	light source

- 22 Edison placed a ball in the middle of a metal box with four hollow tubes and a light source as shown in the diagram.

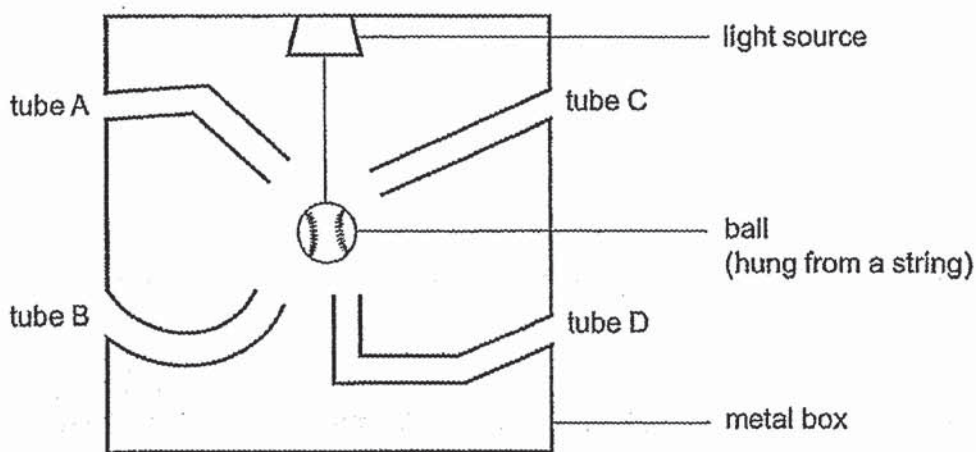

Based on the diagram above, through which tube can he see the ball?

- (1) A
 (2) B
 (3) C
 (4) D

(Go on to the next page)

23 Study the flow chart carefully.

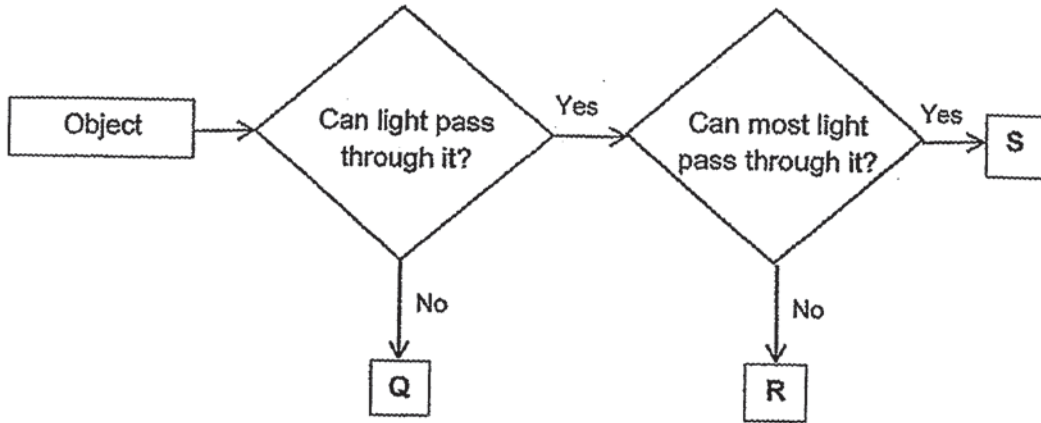

Based on the flow chart above, which of the following best represents objects Q, R and S?

	Q	R	S
(1)	frosted glass	thick cardboard	clear plastic sheet
(2)	thick cardboard	frosted glass	clear plastic sheet
(3)	thick cardboard	clear plastic sheet	frosted glass
(4)	clear plastic sheet	frosted glass	thick cardboard

(Go on to the next page)

24 Colin carried out an experiment in a dark room using the set-up as shown.

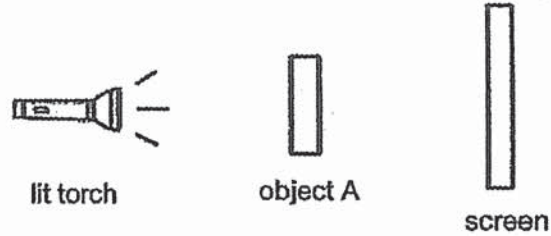

When he switched on the torch, he saw the shadow of object A on the screen as shown in the diagram below.

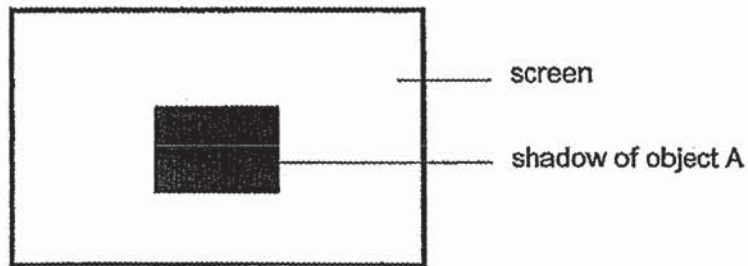

Based only on the observation above, which of the following statements is true?

- (1) Object A did not allow light to pass through.
- (2) Object A allowed most light to pass through.
- (3) The shadow changed shape when the screen was moved nearer to object A.
- (4) The shadow changed shape when the screen was moved further from object A.

(Go on to the next page)

- 25 Edmund walked in a straight line from P to R as shown in the diagram. At Q, he was directly under the lamp. The distance between P and Q is the same as the distance between Q and R.

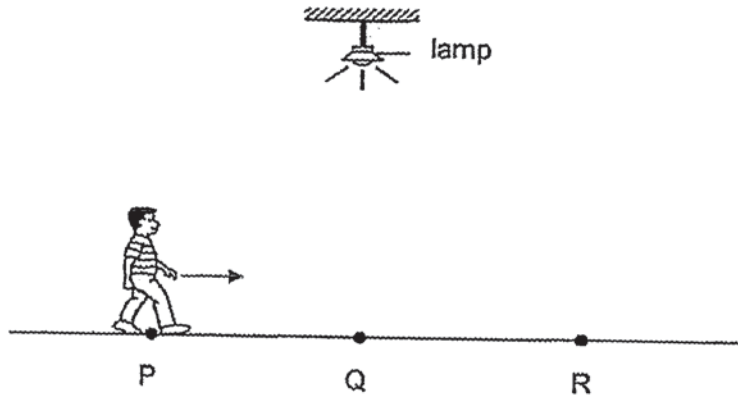

Based on the diagram above, which of the following statements is correct about the length of Edmund's shadow?

- (1) His shadow was the longest when he was at Q.
 - (2) His shadow was the shortest when he was at Q.
 - (3) As he walked from P to Q, his shadow became longer.
 - (4) As he walked from Q to R, his shadow became shorter.
- 26 Andrew placed an ice cube into a beaker filled with hot water.

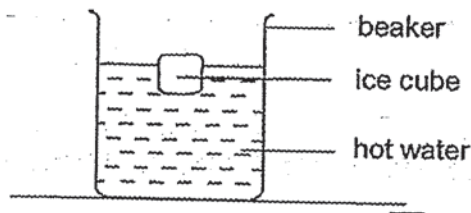

Which of the following statements is correct?

- (1) The ice cube lost heat to the water.
- (2) The water lost heat to the ice cube.
- (3) The ice cube did not gain or lose heat.
- (4) The water gained heat from the beaker.

(Go on to the next page)

- 27 Bala filled up two glasses with the same amount of water. The temperatures of water at the start of the experiment are as shown.

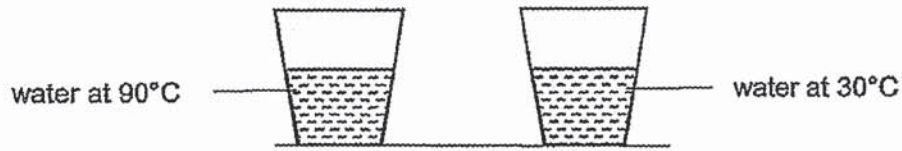

Bala then mixed all the water from both glasses into a large container. He immediately measured the temperature of water in the large container.

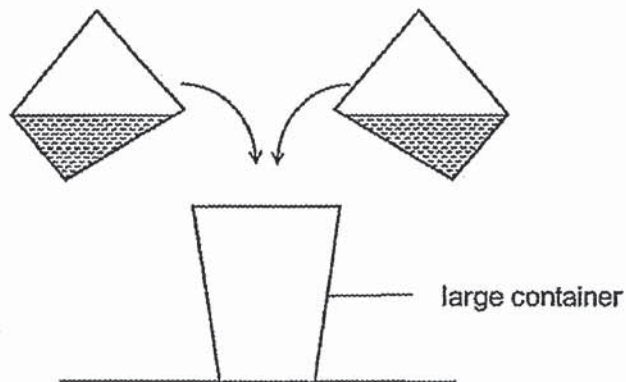

Based on the information given above, the temperature of water in the large container that was immediately measured by Bala was _____.

- (1) 90°C
- (2) higher than 90°C
- (3) between 0°C to 30°C
- (4) between 30°C to 90°C

(Go on to the next page)

- 28 Danny attached a balloon to an empty bottle. He then immersed the bottle in a basin of water at 70°C as shown.

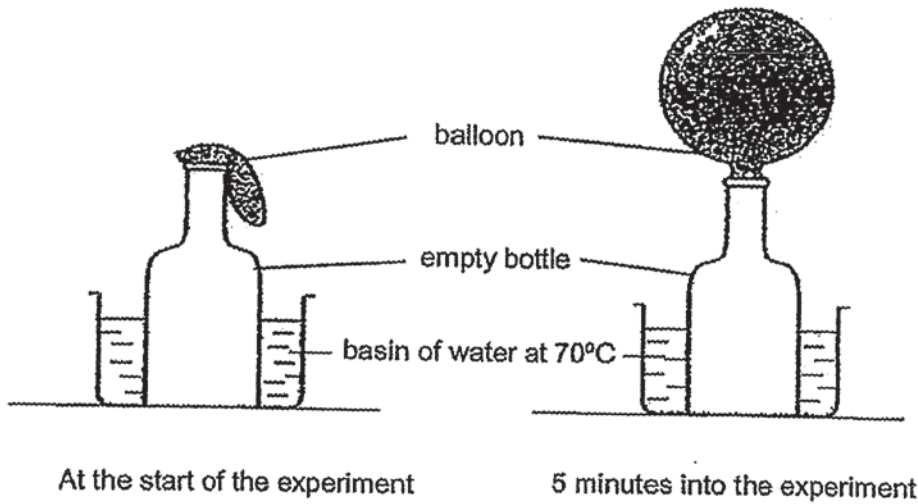

After a while, the balloon was observed to have changed its shape.

Which of the following statements best explains this observation?

- (1) The balloon gained heat and expanded.
- (2) The empty bottle gained heat and expanded.
- (3) The air in the bottle gained heat and expanded.
- (4) The air in the balloon contracted and took up less space.

(Go on to Booklet B)



**Anglo-Chinese School
(Primary)**

A Methodist Institution
(Founded 1886)

**SEMESTRAL ASSESSMENT TWO 2020
SCIENCE
PRIMARY FOUR
BOOKLET B**

Name: _____ ()

Class: Primary 4 _____

Date: 28 October 2020

Total Time for Booklets A and B: 1 h 45 min

Parent's/ Guardian's signature

INSTRUCTIONS TO CANDIDATES

1. Write your name, index number and class in the spaces provided.
2. Do not turn over this page until you are told to do so.
3. Follow all instructions carefully.
4. Answer all questions.
5. Write your answers in this booklet.

BOOKLET	MAX MARKS	MARKS OBTAINED
A	56	
B	44	
Total	100	

This question paper consists of 13 printed pages including this cover page.

For questions 29 to 41, write your answers in this booklet.

The number of marks available is shown in brackets [] at the end of each question or part question. (44 marks)

29 Draw lines to match the following animals to the correct groups. [3]

Animals



Groups

- bird
- fish
- mammal
- amphibian

30 (a) The diagram shows part of the human digestive system. Tick one box to show where the gullet is. [1]

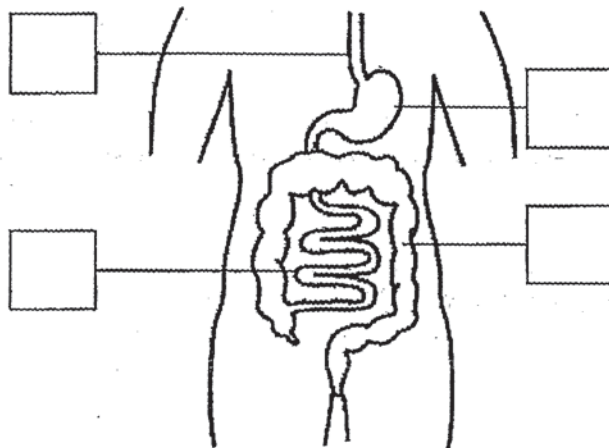

(b) Fill in the blank using the following helping words. [1]

large intestine	stomach	small intestine	mouth
-----------------	---------	-----------------	-------

Food from the gullet is next passed on to the _____.

(Go on to the next page)

Score	5
-------	---

- 31 Andy placed two ring magnets, A and B, through a holder as shown below.

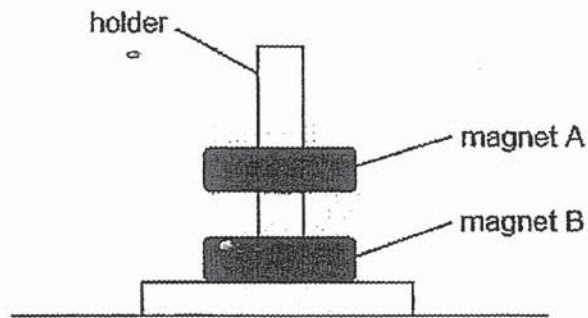

- (a) The holder was made of plastic and did not attract the magnets.

Plastic is a _____ material. [1]

- (b) Why was magnet A floating above magnet B?

Magnet B was _____ magnet A. [1]

- 32 Classify the following into matter and non-matter. [3]

honey	shadow	marble
-------	--------	--------

matter	non-matter

(Go on to the next page)

Score	5
-------	---

33 The diagram shows the life cycle of a cockroach.

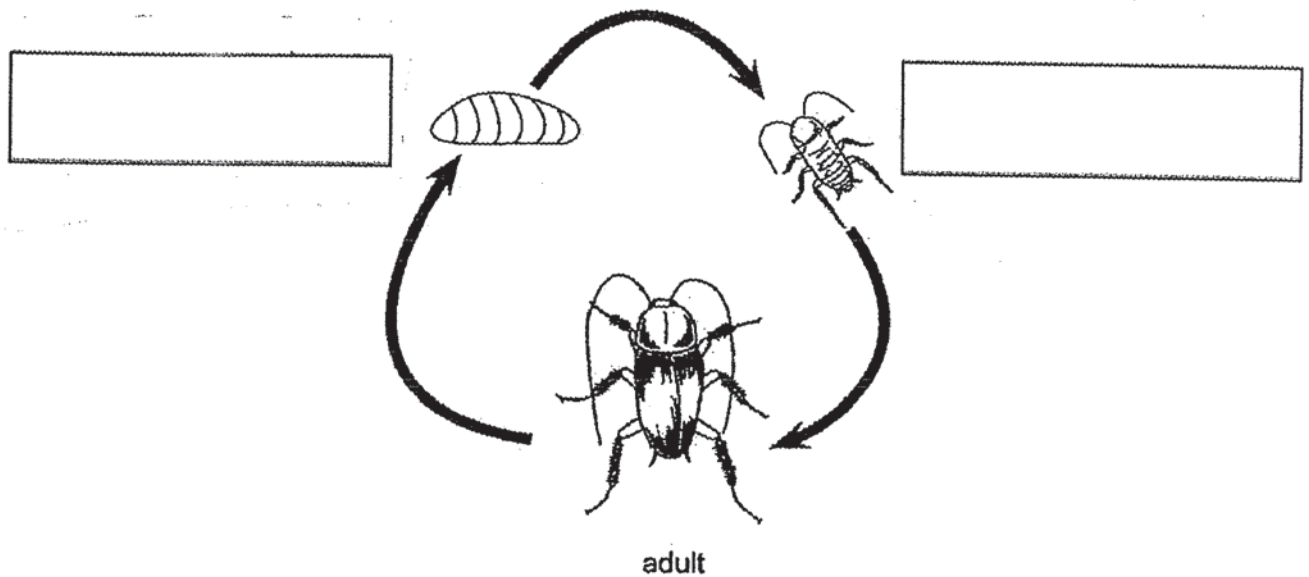

- (a) Label the two missing stages in the boxes provided above. [1]

The table describes the life cycles of four animals, P, Q, R and S.

Description	P	Q	R	S
Young resembles the adult	x	✓	✓	✓
Has three stages in its life cycle	x	✓	x	✓
Young goes through moulting	✓	✓	x	x

- (b) Based on the table above, which animal, P, Q, R or S, best represents a cockroach? [1]

- (c) Based on the table above, state two similarities in the life cycles of animals R and S. [2]

(Go on to the next page)

Score	4
-------	---

34 Study the classification chart carefully.

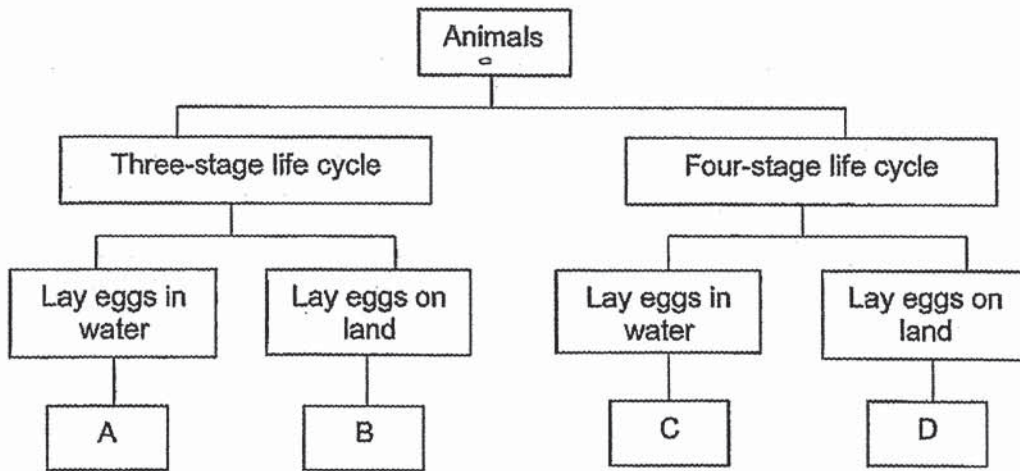

(a) Based on the classification chart above, describe animal A. [1]

(b) State one difference between animals B and C. [1]

(c) (i) Based on the classification chart above, which animal, A, B, C or D, best represents a mosquito? [1]

(ii) A mosquito is considered a pest as it spreads diseases such as dengue fever. The picture shows a stage in the life cycle of a mosquito.

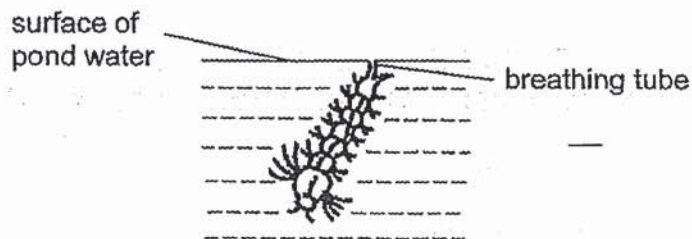

Based on the picture, explain how applying a layer of oil on the surface of the pond water can help to control the number of adult mosquito. [1]

(Go on to the next page)

Score	4
-------	---

- 35 Peter has a container with a capacity of 250 cm^3 . It has 100 cm^3 of water inside. He connected a pump to the container and pushed the plunger of the pump once. Each push pumps 50 cm^3 of air into the container.

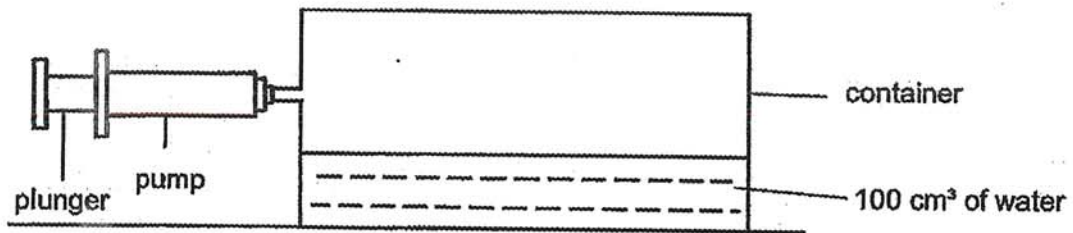

- (a) In the table below, write down the volume of air in the container before and after air was pumped into the container. [2]

Volume of air in container before air was pumped (cm^3)	Volume of air in container after air was pumped (cm^3)

- (b) What property of air is shown in this experiment? [1]

Next, Peter took four identical beakers, K, L, M and N. He placed four stones of a different volume into each beaker. Then, he filled each beaker to the brim with water as shown in the diagram.

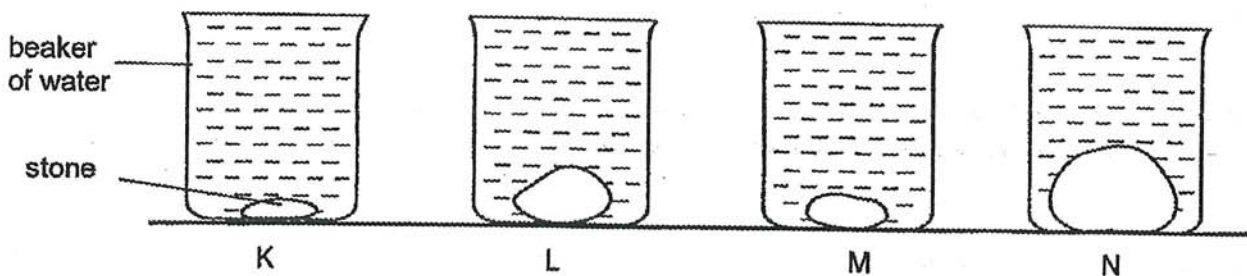

- (c) Which of the beakers, K, L, M or N is filled with the greatest amount of water? [1]

(Go on to the next page)

Score	4
-------	---

- 36 Jason conducted an experiment using two similar containers A and B, each fitted with a glass tube and a funnel. He put a stopper in the glass tube that was fitted into container B. Next, he poured water into each funnel.

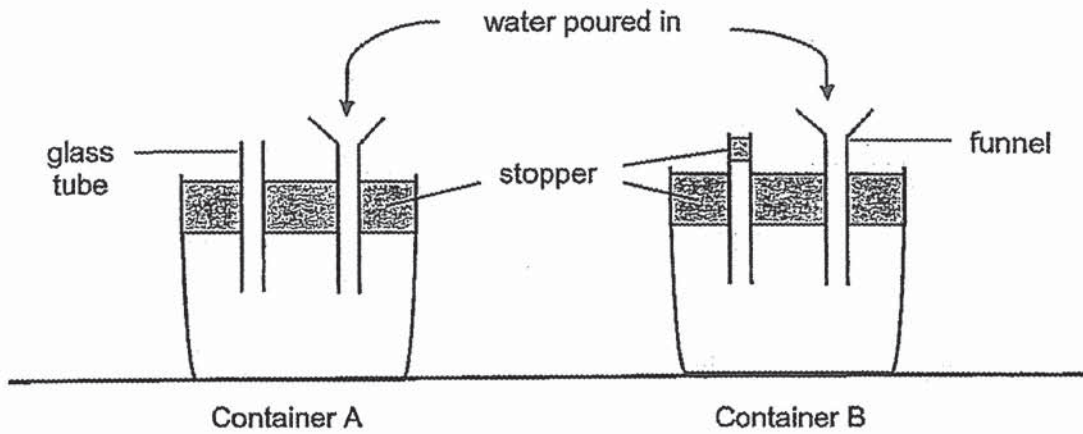

- (a) In which container, A or B, can water flow in faster? [1]

Jason conducted another experiment with two identical plastic cups X and Y. He inverted both cups into a basin of water. One of the cups had a hole at the bottom while the other cup did not have any holes. The result of the experiment is as shown.

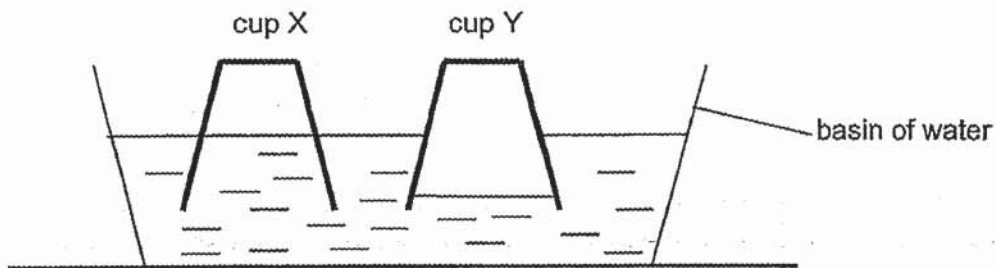

- (b) Based on the diagram above, which cup, X or Y, had a hole at the bottom? [1]

- (c) Explain your answer in part (b). [2]

(Go on to the next page)

Score	4
-------	---

- 37 Terry wanted to find out how the distance between the lamp and the object affects the height of the shadow formed on the screen. He set up an experiment as shown.

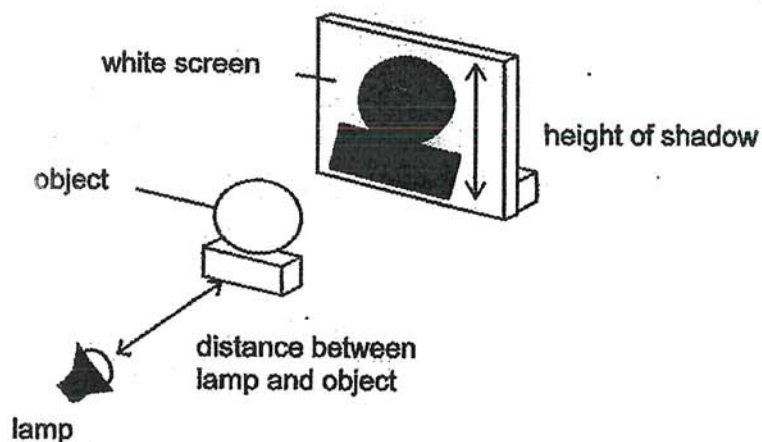

He recorded his results in the table below.

Distance between lamp and object (cm)	Height of shadow formed on the white screen (cm)
20	7
15	9
10	11
5	13

- (a) Predict the height of the shadow formed on the white screen if the distance between the lamp and the object is 8 cm.

Ans: _____ cm

[1]

- (b) Where should the object be placed so that the height of the shadow is the same as the height of the object? [1]

- (c) Based on the results in the table above, what could Terry conclude? [1]

(Go on to the next page)

Score	3
-------	---

38 Devi shines a lit torch on a soft drink can from positions 1 and 2. As a result, shadows are formed on screens A and B.

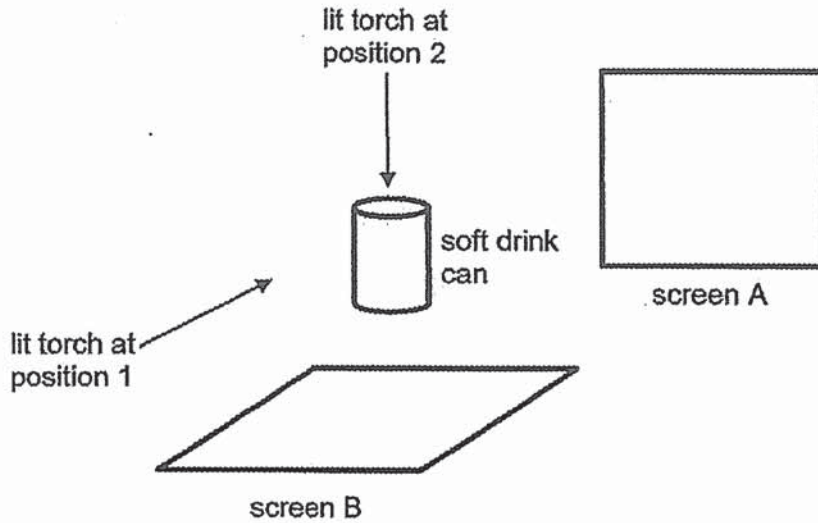

- (a) Name the shape of the shadow that Devi will see on screens A and B. Fill in the blank using the following helping words.

circle	triangle	rectangle	square
--------	----------	-----------	--------

Screen A: _____ [1]

Screen B: _____ [1]

- (b) Based on your answer in part (a), what does this experiment show about the effect of the position of light source on shadows formed? [1]

- (c) Describe how the size of the shadow will change when the screen is moved closer to the object. [1]

- (d) Explain your answer to part (c). [1]

(Go on to the next page)

Score	5
-------	---

- 39 Jimmy prepared the following set-ups as shown in the diagram.

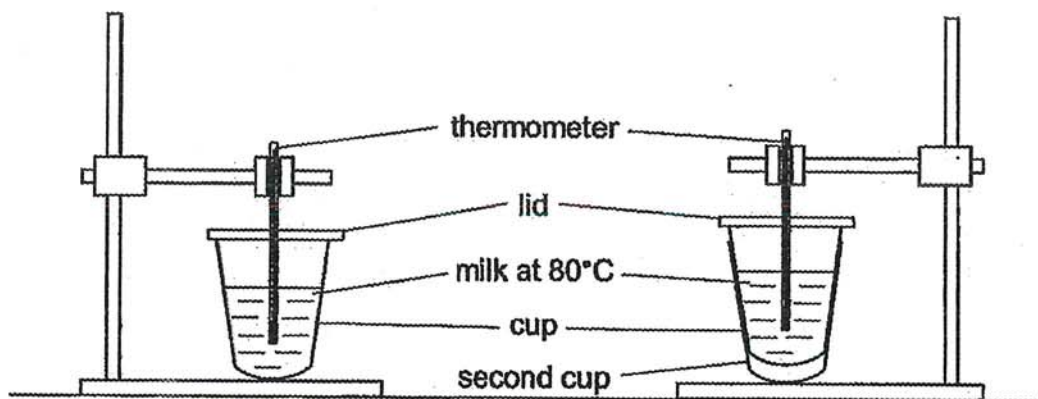

The temperature of the milk in each set-up is recorded at ten-minute intervals as shown in the table below.

	Time (minute)					
	0	10	20	30	40	50
Temperature ($^{\circ}\text{C}$) of milk in set-up A	80	60	40	25	25	25
Temperature ($^{\circ}\text{C}$) of milk in set-up B	80	70	60	40	25	25

- (a) Which set-up, A or B, kept the milk warmer for a longer period of time? [1]
Set-up _____
- (b) Explain how the set-up stated in part (a) helped keep the milk warmer? [1]

- (c) Explain why there was no difference in the temperature of milk between both set-ups from the 40th minute onwards. [1]

(Go on to the next page)

Score	3
-------	---

- 40 Kieran carried out an experiment to investigate how fast heat is lost from a test tube and a beaker as shown. The test tube and beaker each contained a different amount of hot water at 60°C.

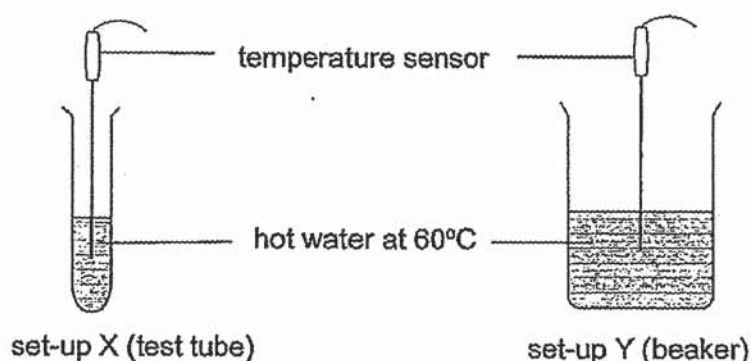

The temperature of water in the test tube and beaker was taken using a temperature sensor over a period of time. The table below shows the results.

	Temperature of water (°C)					
set-up X (test tube)	60	45	33	29	28	28
set-up Y (beaker)	60	52	45	39	35	32

- (a) What is the changed variable in Kieran's experiment? [1]

- (b) Based on the results above, what can you conclude about how fast heat is lost from the hot water in set-up X compared to the hot water in set-up Y? Explain your answer. [2]

(Go on to the next page)

Score	3
-------	---

- 41 Kelvin had two glasses that were tightly stuck as shown in diagram 1. He managed to separate them by dipping glass B into a basin of hot water as shown in diagram 2.

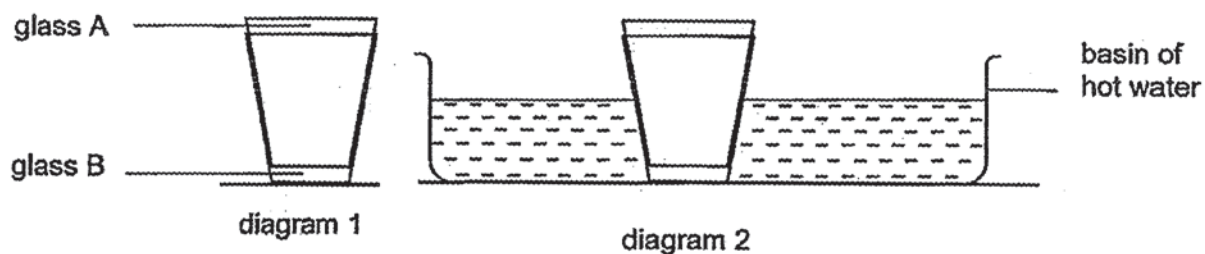

- (a) Explain how placing glass B into a basin of hot water enabled Kelvin to separate the two glasses. [1]

- (b) State another method to separate the two glasses. [1]

(Go on to the next page)

Score	2
-------	---

A metal rim can be fitted tightly around a wooden wheel using the following steps as shown in the diagrams below.

Step 1:
The metal rim is heated.

Step 2:
The heated metal rim is fitted around the wooden wheel.

Step 3: The metal rim is poured over by cold water.

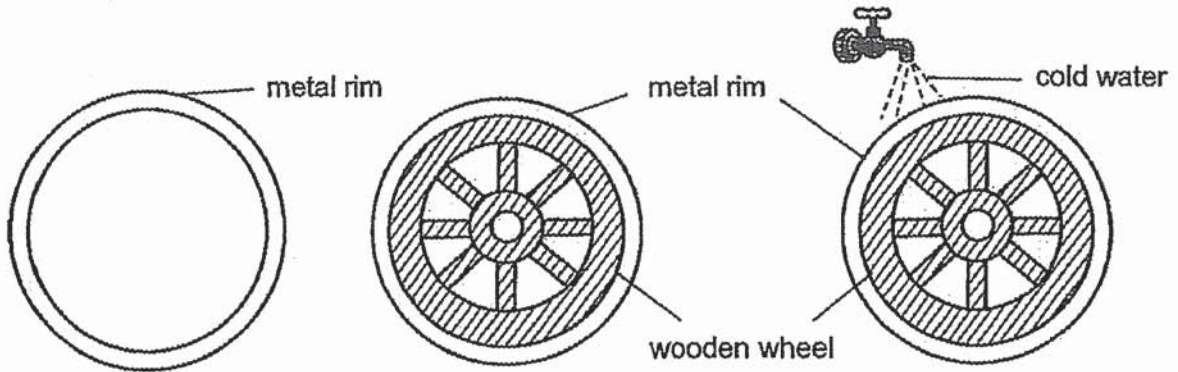

- (c) Based on Kelvin's experiment, explain how each of the following steps helped fit the metal rim tightly around the wooden wheel. [2]









Step	Explanation
1. The metal rim is heated.	
3. The metal rim is poured over by cold water.	

YEAR : 2020
LEVEL : PRIMARY 4
SCHOOL : ANGLO CHINESE SCHOOL
SUBJECT : SCIENCE
TERM : SA2

BOOKLET A

Q1	3	Q2	3	Q3	1	Q4	2	Q5	3
Q6	4	Q7	4	Q8	2	Q9	4	Q10	1
Q11	1	Q12	2	Q13	4	Q14	2	Q15	1
Q16	2	Q17	3	Q18	3	Q19	2	Q20	1
Q21	1	Q22	3	Q23	2	Q24	1	Q25	2
Q26	2	Q27	4	Q28	3				

BOOKLET B

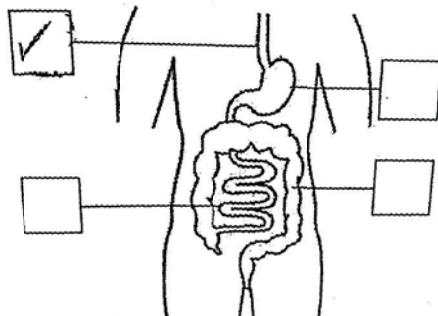
<p>Q29</p>	<table border="0" style="width: 100%;"> <thead> <tr> <th style="text-align: left;">Animals</th> <th style="text-align: right;">Groups</th> </tr> </thead> <tbody> <tr> <td style="text-align: center;">  </td> <td style="text-align: right;"> <ul style="list-style-type: none"> • bird • fish • mammal • amphibian </td> </tr> <tr> <td style="text-align: center;">  </td> <td></td> </tr> <tr> <td style="text-align: center;">  </td> <td></td> </tr> </tbody> </table> <p><i>Watermark: KIPAPER.com Paper Delivery Whatsapp Only 88660057</i></p>	Animals	Groups		<ul style="list-style-type: none"> • bird • fish • mammal • amphibian 				
Animals	Groups								
	<ul style="list-style-type: none"> • bird • fish • mammal • amphibian 								
									
									
<p>Q30</p>	<p>a)</p> 								

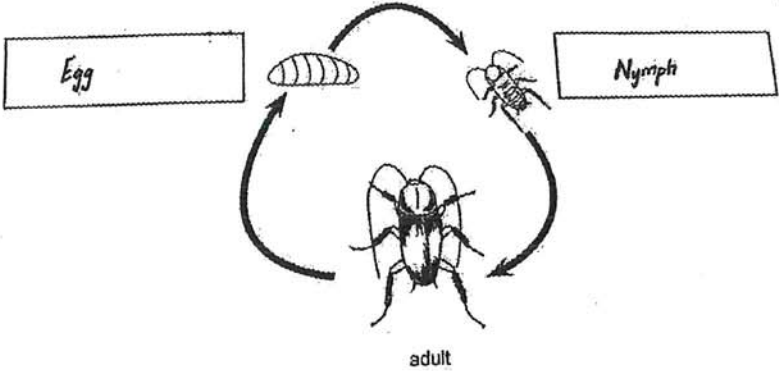
	b) Stomach
Q31	a) non-magnetic b) Repelling
Q32	Honey and marble is matter while a shadow is a non-matter.
Q33	<p>a)</p>  <p>b) Animal R c) Both animal R and S young resemble the adult and their young does not go through molting.</p>
Q34	<p>a) Animal A has a three-stage life cycle and lays eggs in water. b) Animal B lays egg on land while animal C lays eggs in water. c) Animal C cii) By applying a layer of oil on the surface of the pond it will block out the air from entering the breathing tube of the mosquito thus the mosquito will not survive which will help maintain a safe number of mosquito.</p>
Q35	<p>a) Both volume of air before and after is 150cm³. b) Air can be compressed. c) Beaker K</p>
Q36	<p>a) Container A b) Cup X c) If a cup has a hole in it the amount of water flow into it will be the same level as the water level of the basin of water which is shown in the diagram cup X does. Thus cup X does have a hole in it.</p>
Q37	<p>a) 12cm b) The object should be placed right on the screen. c) The bigger the distance between the lamp and the object the shorter the height of the shadow formed on the screen.</p>

Q38	<p>a) Screen A: rectangle Screen B: Circle</p> <p>b) The different position of the lit torch, the different shape of the object.</p> <p>c) The height of the shadow will decrease.</p> <p>d) When the object is farther away from the light source and nearer to the screen, it's height decrease.</p>						
Q39	<p>a) Set-up B</p> <p>b) The milk in set up B lost heat due to the surrounding air.</p> <p>c) The temperature of the ilk reached room temperature.</p>						
Q40	<p>a) The change variable is the amount of liquid.</p> <p>b) The lesser the amount of water the faster the heat lost, set up X has lesser water so heat lost is faster compared to set up Y which has more water will take longer time to cool down.</p>						
Q41	<p>a) Glass B will heat up and expand while glass A will not gain heat and remain the same. Thus glass B will expand making glass A easy to pull out.</p> <p>b) Place ice cubes in glass A.</p> <p>c) 1</p>						
	<table border="1"> <thead> <tr> <th data-bbox="341 1536 842 1576">Step</th> <th data-bbox="852 1536 1350 1576">Explanation</th> </tr> </thead> <tbody> <tr> <td data-bbox="341 1585 842 1751">1. The metal rim is heated.</td> <td data-bbox="852 1585 1350 1751">The heat cause the metal ring expand so that it will bigger than the wooden wheel.</td> </tr> <tr> <td data-bbox="341 1760 842 1926">3. The metal rim is poured over by cold water.</td> <td data-bbox="852 1760 1350 1926">The cold water will make the metal ring to contract and tighten the wooden wheel.</td> </tr> </tbody> </table>	Step	Explanation	1. The metal rim is heated.	The heat cause the metal ring expand so that it will bigger than the wooden wheel.	3. The metal rim is poured over by cold water.	The cold water will make the metal ring to contract and tighten the wooden wheel.
Step	Explanation						
1. The metal rim is heated.	The heat cause the metal ring expand so that it will bigger than the wooden wheel.						
3. The metal rim is poured over by cold water.	The cold water will make the metal ring to contract and tighten the wooden wheel.						