

CNG / CTEO / HKY / JT & ME / MS

SINGAPORE CHINESE GIRLS' SCHOOL
SECOND SEMESTRAL ASSESSMENT 2020

PRIMARY 4
MATHEMATICS
BOOKLET A

Name : _____ ()

29 October 2020

Class : Primary 4 SY/C/G/SE/P

Parent's Signature

There are 15 questions in this booklet.
SECTION A

Total Time : 1 h 45 min (Booklet A and B)

INSTRUCTIONS TO CANDIDATES

DO NOT OPEN THIS BOOKLET UNTIL YOU ARE TOLD TO DO SO.

FOLLOW ALL INSTRUCTIONS CAREFULLY.

ANSWER ALL QUESTIONS.

CHECK THAT ALL MCQ ANSWERS ARE SHADED CORRECTLY IN THE OAS

This question paper consists of 5 printed pages.

Section A: (30 marks)

Questions 1 to 15 carry 2 marks each. For each question, four options are given. One of them is the correct answer. Make your choice (1, 2, 3 or 4). Shade the correct oval (1, 2, 3 or 4) on the Optical Answer Sheet.

1. The value of the digit 6 in 54 162 is _____.
 - (1) 60
 - (2) 600
 - (3) 6000
 - (4) 60 000

2. 31 248 rounded to the nearest hundred is _____.
 - (1) 31 000
 - (2) 31 200
 - (3) 31 300
 - (4) 32 000

3. $20\,000 + 4000 + 100 + 8 =$ _____
 - (1) 24 180
 - (2) 24 108
 - (3) 24 018
 - (4) 20 418

4. The digit 7 in 6.172 stands for 7 _____.
 - (1) ones
 - (2) tens
 - (3) tenths
 - (4) hundredths

5. Which of the following decimals is the greatest?

- (1) 0.542
- (2) 0.512
- (3) 0.052
- (4) 0.135

6. How many one-thirds are there in 3 wholes?

- (1) 1
- (2) 6
- (3) 3
- (4) 9

7. What fraction of the figure is shaded?

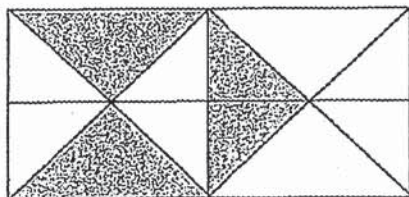

- (1) $\frac{3}{8}$
- (2) $\frac{5}{8}$
- (3) $\frac{1}{3}$
- (4) $\frac{1}{4}$

8. Which fraction is greater than $\frac{1}{2}$?

(1) $\frac{2}{4}$

(2) $\frac{2}{6}$

(3) $\frac{3}{5}$

(4) $\frac{4}{9}$

9. Which of the following is a multiple of both 4 and 8?

(1) 12

(2) 2

(3) 16

(4) 4

10. Write $2\frac{9}{20}$ as a decimal.

(1) 2.045

(2) 2.29

(3) 2.45

(4) 2.9

11. Round 75.49 to the nearest ten.

(1) 70

(2) 75

(3) 76

(4) 80

12. What is the missing number?

6.062 , 5.842 , _____ , 5.402 , 5.182

- (1) 5.622
- (2) 5.662
- (3) 6.062
- (4) 6.662

13. In the figure, how many of the marked angles are right angles?

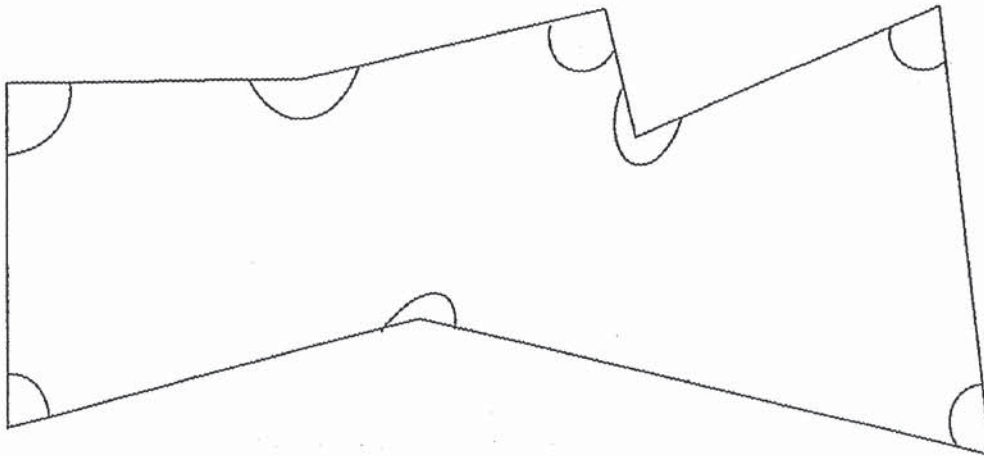

- (1) 1
- (2) 2
- (3) 3
- (4) 4

14. In the figure shown, ABCD is a square. Find $\angle BDE$.

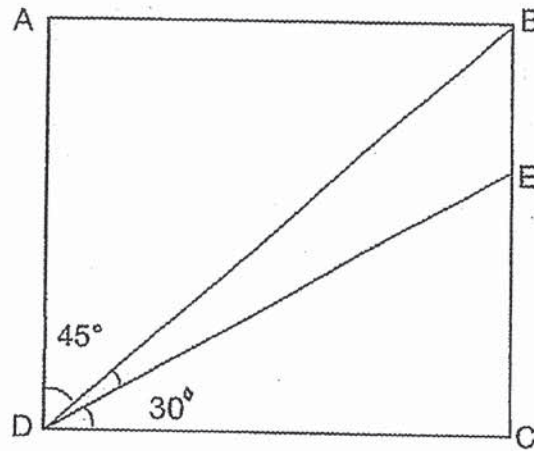

- (1) 10°
 - (2) 15°
 - (3) 45°
 - (4) 80°
15. The figure shown is made up of a square **S** of side 3 cm and a rectangle **R** with breadth 4 cm. What is the length of the rectangle?

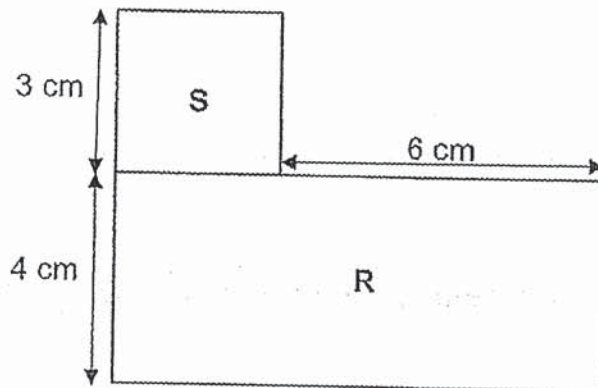

- (1) 10 cm
- (2) 9 cm
- (3) 3 cm
- (4) 7 cm

End of Section A

CNG / CTEO / HKY / JT / ME / MS

SINGAPORE CHINESE GIRLS' SCHOOL
SECOND SEMESTRAL ASSESSMENT 2020
PRIMARY 4
MATHEMATICS
BOOKLET B

Name : _____ ()

29 October 2020

Class : Primary 4 SY/C/G/SE/P

		Marks attained	Max Mark
Booklet A	Section A		30
Booklet B	Section B		40
	Section C		30
Total			100

Parent's Signature

There are 28 questions in this booklet.
SECTION B and C

Total Time : 1 h 45 min (Booklet A and B)

INSTRUCTIONS TO CANDIDATES

DO NOT OPEN THIS BOOKLET UNTIL YOU ARE TOLD TO DO SO.
FOLLOW ALL INSTRUCTIONS CAREFULLY.
ANSWER ALL QUESTIONS.

This question paper consists of 13 printed pages.

Section B: (40 marks)

Questions 16 to 35 carry 2 marks each. Write your answers in the space provided. For questions which require units, give your answers in the units stated.

Do not write
in this column

16. Write 14 012 in words.

Ans: _____

17. What is the remainder when 3126 is divided by 8?

Ans: _____

18. Write the decimal represented by A.

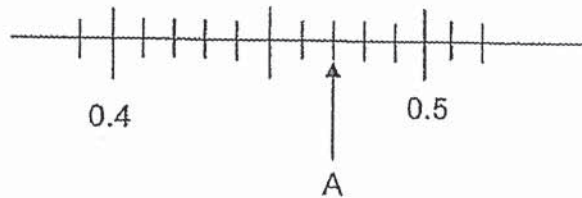

Ans: _____

19. Find the value of 60.25×9 .

Ans: _____

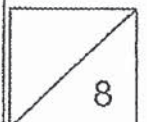

20. Express $\frac{4}{12}$ in its simplest form.

Ans: _____

21. Write $\frac{19}{5}$ as a mixed number.

Ans: _____

22. Find the value of $1 - \frac{1}{8} - \frac{1}{4}$.

Ans: _____

23. Arrange the following numbers in order from the smallest to the greatest.

0.512 , 4.8 , 0.609 , 0.085

Ans: _____ , _____ , _____ , _____
(smallest) (greatest)

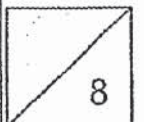

24. XY is a straight line.

Draw a line perpendicular to XY passing through point Z.



25. In the figure, one of the lines is parallel to BE. Which line is parallel to BE?

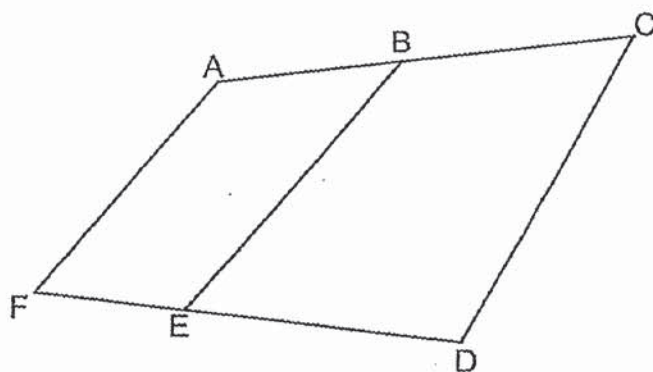

Ans: _____

26. Measure and write down the size of $\angle x$.

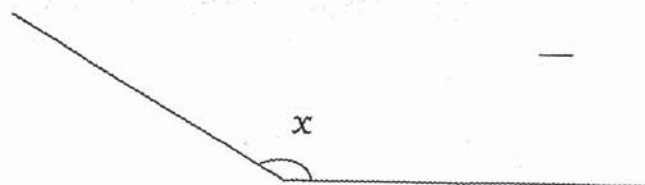

Ans: _____°

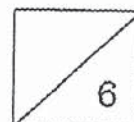

27. Xiao Ming is facing South. He makes a $\frac{1}{2}$ turn anti-clockwise. Then he turns 270° clockwise. Where will he be facing now?

Do not write in this column

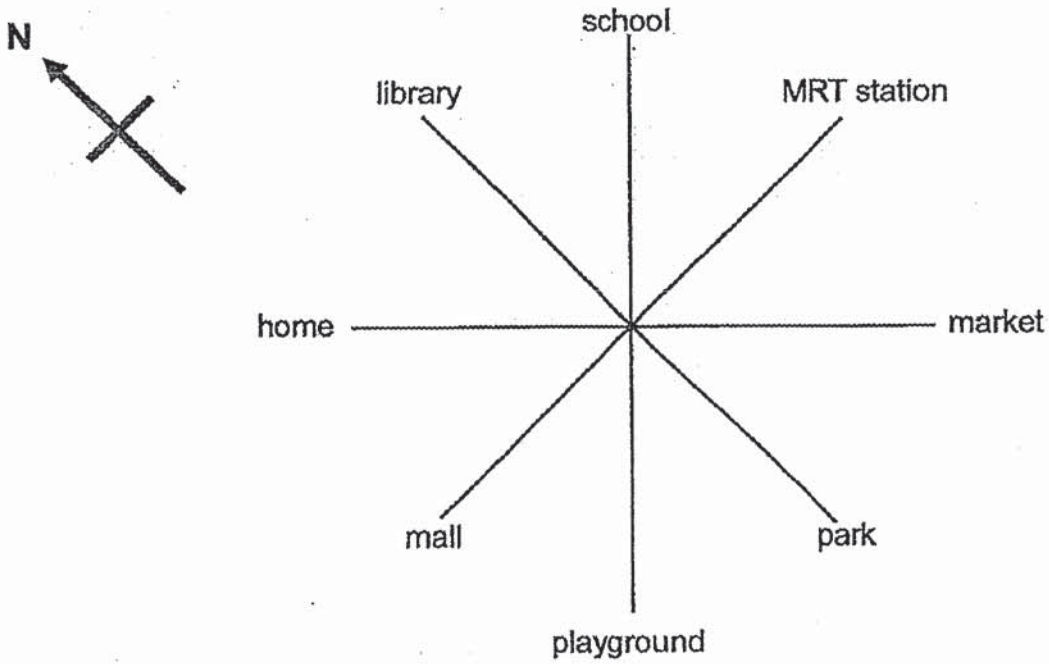

Ans: _____

28. Complete the figure to form a symmetric shape along the dotted line.

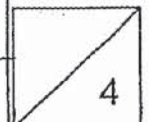
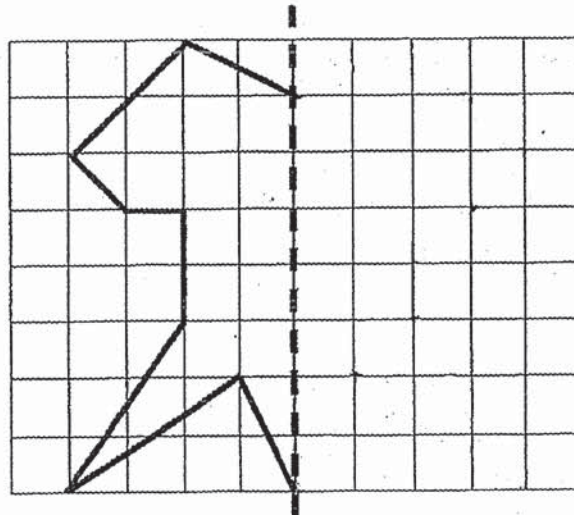

29. The length of a rectangle is twice its breadth.
The perimeter of the rectangle is 42 m.
What is the breadth of the rectangle?

Do not write
in this column

Ans: _____ m

30. The figure below is made up of a rectangle ABCH and a square DEFG.
Find the perimeter of the figure.

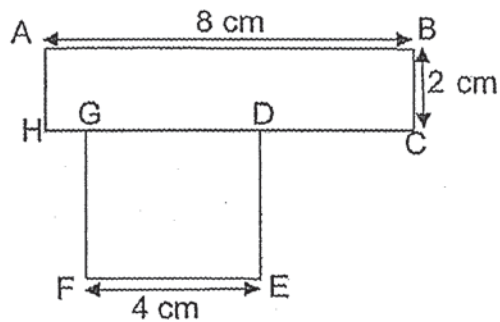

Ans: _____ cm

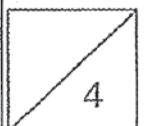

The following line graph shows the number of children at a library from 11 a.m. to 3 p.m.

Do not write
in this column

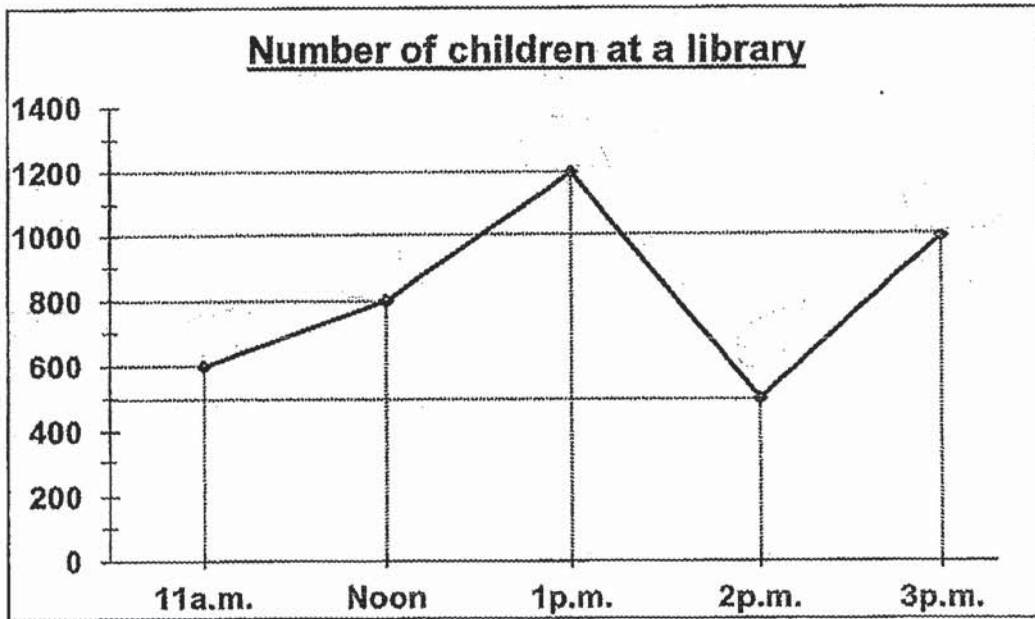

31. In which one-hour period did the number of children increase the most?

Ans: _____ to _____

32. How many fewer children were there in the library at 11 a.m. than noon?

Ans: _____

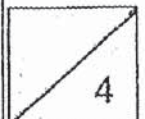

The graph below shows the time taken in a swimming competition.

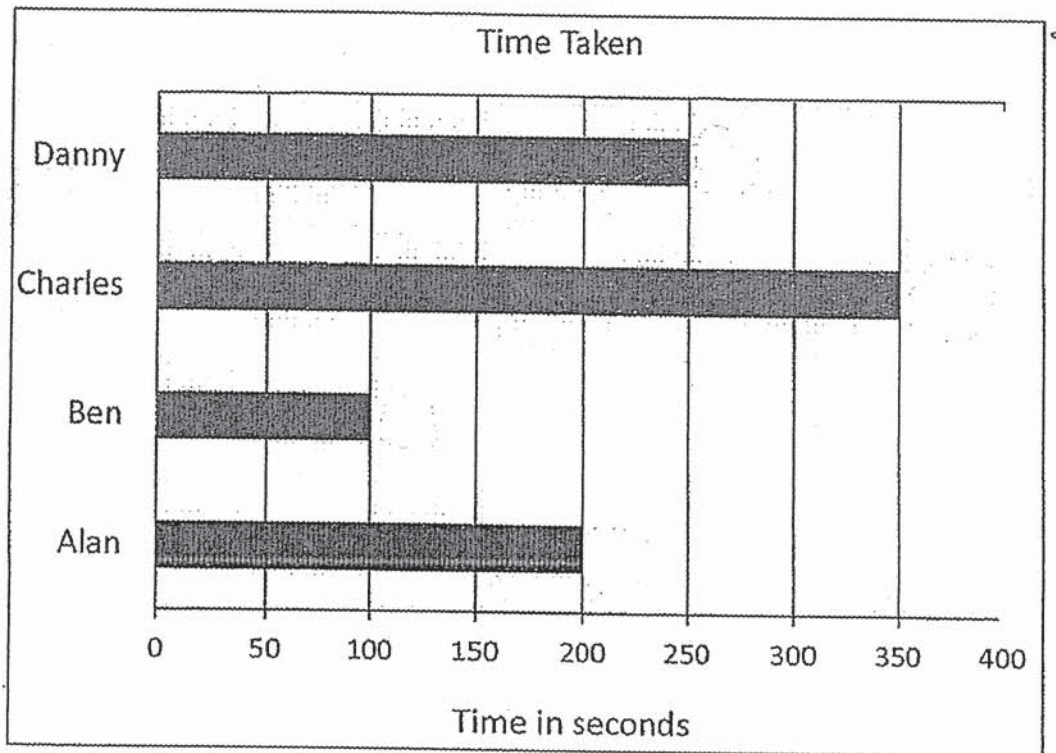

Do not write
in this column

33. Who swam the slowest in the swimming competition?

Ans: _____

34. I am an even number. I am a multiple of 2 and a factor of 42.
I am not 2 or 42. I am less than 10.
What number am I?

Ans: _____

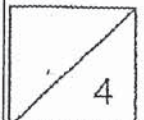

35. The square ABCD below is made up of two identical rectangles. The area of one rectangle is 50 cm^2 . What is the length of BC?

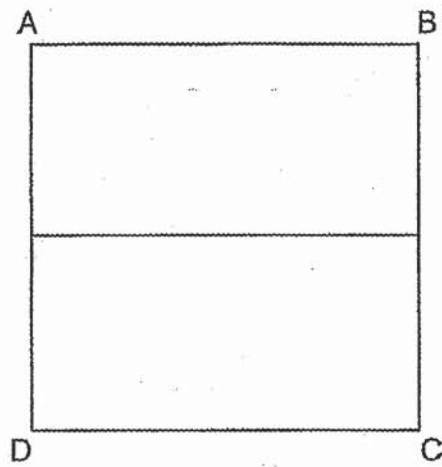

Do not write
in this column

Ans: _____ cm

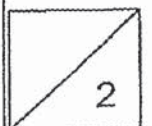

Section C: (30 marks)

For questions 36 to 43, show your working clearly in the space provided for each question and write your answer in the space provided. The number of marks available is shown in the brackets [] at the end of each question or part-question.

Do not write
in this column

36. There were 2750 people at a carnival.
1050 were adults and there were 300 more girls than boys.
- (a) How many children were there?
(b) How many boys were there?

Ans: (a) _____ [2]

Ans: (b) _____ [2]

37. There were street lamps along a footpath measuring 32 m.
The distance between 2 street lamps is 4 m. How many street lamps are there?

Do not write
in this column

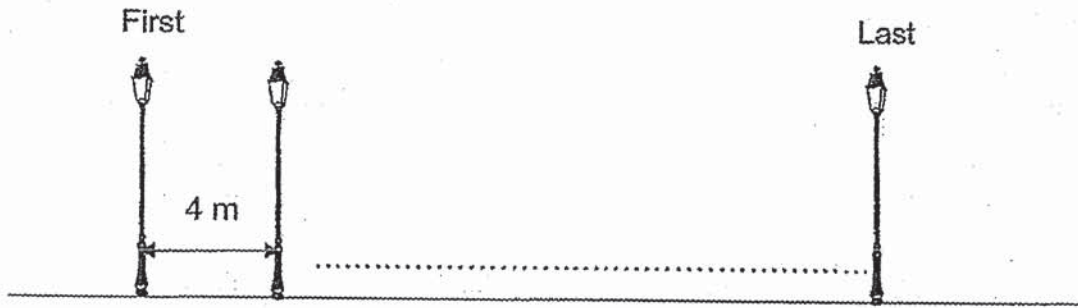

Ans: _____ [3]

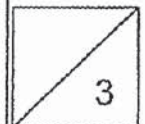

38. There were some jelly beans in a jar.

$\frac{1}{3}$ of them were purple, $\frac{2}{9}$ of them were yellow and the rest were orange.

There were 312 orange jelly beans.

How many jelly beans are there altogether?

Do not write
in this column

Ans: _____ [4]

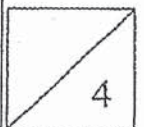

39. Mei Fong had $\frac{4}{5}$ kg of flour. However, she spilled $\frac{1}{2}$ kg of flour on the floor.

She needed 3 kg of flour to bake butter cakes.

- (a) How much flour had she left?
(b) How much **more** flour did Mei Fong need?

Do not write
in this column

Ans (a) _____ [2]

(b) _____ [2]

40. Ali bought 8 chocolate donuts at \$2.35 each. He also bought 4 strawberry donuts. If he paid \$30 for all the donuts, how much did he pay for each strawberry donuts?

Ans: _____ [4]

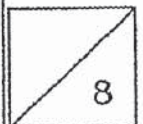

Do not write
in this column

41. Josephine had thrice as much orange juice as apple juice.
After she poured out 1.08 l apple juice, she had 5 times as much orange
juice. How much apple juice did Josephine have at first?

Ans: _____ [4]

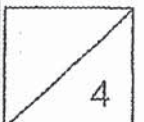

42. The perimeter of the rectangular piece of paper measuring 14 cm by 8 cm is 48 cm after a small square was cut from it.

- (a) What is the length of each side of the small square that was cut?
- (b) After the small square was cut out, what is the area of the rectangular piece of paper left?

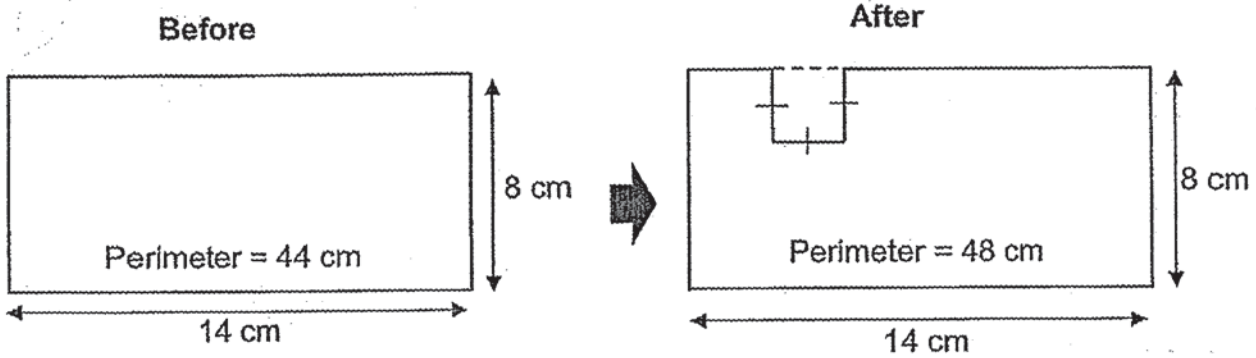

Ans: (a) _____ [2]

Ans: (b) _____ [2]

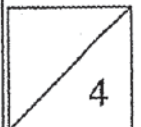

43. Aminah folded 50 more paper cranes than Lucy.
If Aminah gave 16 paper cranes to Lucy, how many more paper cranes
would Aminah have than Lucy now?

Ans: _____ [3]

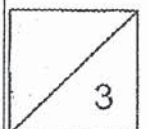

ANSWER KEY

YEAR : 2020

LEVEL : PRIMARY 4

SCHOOL ; SINGAPORE CHINESE GIRLS' SCHOOL

SUBJECT: MATHEMATICS

TERM: SECOND SEMESTRAL ASSESSMENT

BOOKLET A

Q1	1	Q2	2	Q3	2	Q4	4	Q5	1
Q6	4	Q7	1	Q8	3	Q9	3	Q10	3
Q11	4	Q12	1	Q13	2	Q14	2	Q15	2

BOOKLET B

Q16. Fourteen thousand and twelve

Q17. 6

Q18. 0.47

Q19. 542.25

Q20. $\frac{1}{3}$

Q21. $3\frac{4}{5}$

Q22. $\frac{5}{8}$

Q23. 0.085, 0.512, 0.609, 4.8

Q24.



- Q25. AF
 Q26. 150°
 Q27. Mall
 Q28.

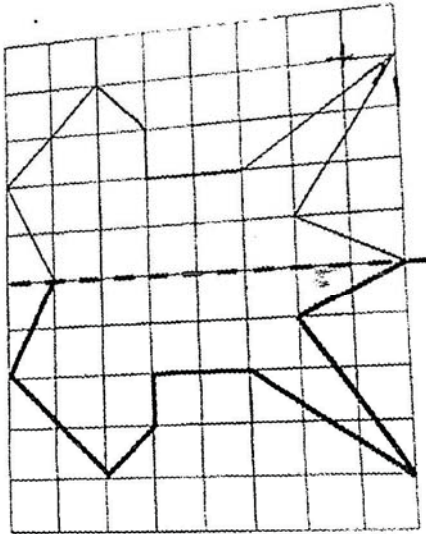

- Q29. 7
 Q30. 28cm
 Q31. 2pm to 3pm
 Q32. 200
 Q33. Charles
 Q34. 6
 Q35. 10cm

BOOKLET C

Q36.

a) $2750 - 1050 = 1700$

b) $1700 - 300 = 1400$

$1400 \div 2 = 700$

Q37. $32 \div 8 = 4$

$8 + 1 = 9$

Q38. $312 \div 4 = 78$

$78 \times 9 = 702$

Q39.

a) $\frac{4}{5} - \frac{1}{2} = \frac{3}{10}$

b) $3 - \frac{3}{10} = 2\frac{7}{10}$

Q40.

$$2.35 \times 8 = 18.80$$

$$20 - 18.80 = 11.20$$

$$11.20 \div 4 = 2.80$$

Q41.

$$1.08 \div 2 = 0.54$$

$$0.54 \times 5 = 2.70$$

Q42.

$$48 - 4 = 44$$

$$4 \div 2 = 2 \text{ (a)}$$

$$2 \times 2 = 4$$

$$14 \times 8 = 112$$

$$112 - 4 = 108 \text{ (b)}$$

Q43.

$$16 \times 2 = 32$$

$$50 - 32 = 18$$

3

END