



RED SWASTIKA SCHOOL

# RED SWASTIKA SCHOOL

## 2020 SEMESTRAL ASSESSMENT 2

### MATHEMATICS

Name : \_\_\_\_\_ ( )

Class : Primary 4 / \_\_\_\_\_

Date : 29 Oct 2020

### BOOKLET A

20 Questions

40 Marks

Duration of Paper : 1 hour 45 minutes

**Note:**

1. Do not open this Booklet until you are told to do so.
2. Read carefully the instructions given at the beginning of each part of the Booklet.
3. Do not waste time. If a question is difficult for you, go on to the next one.
4. Check your answers thoroughly and make sure you attempt every question.
5. In this booklet, you should have the following:
  - (a) Page 1 to Page 8
  - (b) Questions 1 to 20

Questions 1 to 20 carry 2 marks each. For each question, four options are given. One of them is the correct answer. Make your choice (1, 2, 3 or 4). Shade the correct oval (1, 2, 3 or 4) on the Optical Answer Sheet.

(40 marks)

1 In the number 56 780, which digit is in the tens place?

- (1) 5
- (2) 6
- (3) 7
- (4) 8

2 Which number below is 10 more than 3581?

- (1) 3582
- (2) 3591
- (3) 3681
- (4) 4581

3 What fraction of the shapes in the box are ✕ ?

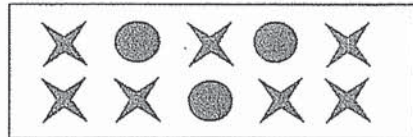

- (1)  $\frac{3}{10}$
- (2)  $\frac{3}{7}$
- (3)  $\frac{7}{10}$
- (4)  $\frac{7}{3}$

4  $5\frac{3}{4} = \frac{\square}{4}$

What is the missing number in the box?

- (1) 15
- (2) 17
- (3) 20
- (4) 23

5 In the figure below, which angle is smaller than a right angle?

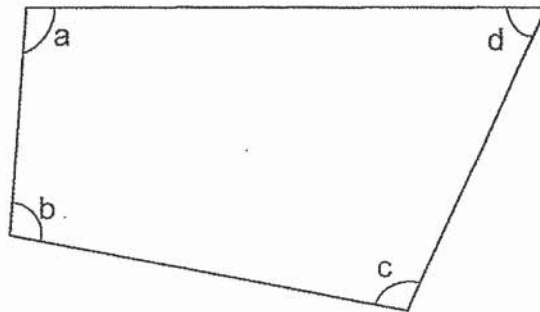

- (1)  $\angle a$
- (2)  $\angle b$
- (3)  $\angle c$
- (4)  $\angle d$

6 Express 0.06 as a fraction in its simplest form.

- (1)  $\frac{3}{50}$
- (2)  $\frac{3}{5}$
- (3)  $\frac{1}{60}$
- (4)  $\frac{1}{6}$

- 7 56 is **not** a multiple of \_\_\_\_\_.
- (1) 8  
 (2) 7  
 (3) 6  
 (4) 4
- 8 Shaun went into the library at 13 55. Given that Shaun stepped out of the library at 15 40, how long did he spend in the library?
- (1) 105 mins  
 (2) 135 mins  
 (3) 145 mins  
 (4) 185 mins
- 9 A number when rounded to the nearest thousand is 12 000. What is the greatest possible value of that number?
- (1) 11 999  
 (2) 12 449  
 (3) 12 499  
 (4) 12 999
- 10 The table below shows the number of \$1 coins, \$2 and \$5 notes collected by four students during the first hour of a fundraising event.

Student	\$1 coin	\$2 note	\$5 note
Alison	8	15	10
Beatrice	10	15	10
Charles	10	10	10
Danny	8	15	8

Who collected the most amount of money?

- (1) Alison  
 (2) Beatrice  
 (3) Charles  
 (4) Danny

11 How many symmetric figure(s) is/are there below?

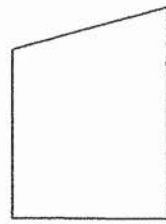

Figure A

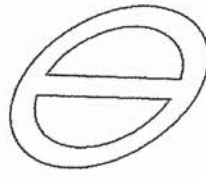

Figure B

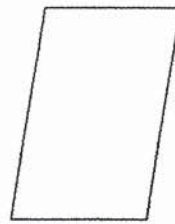

Figure C

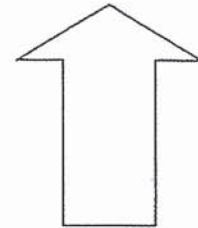
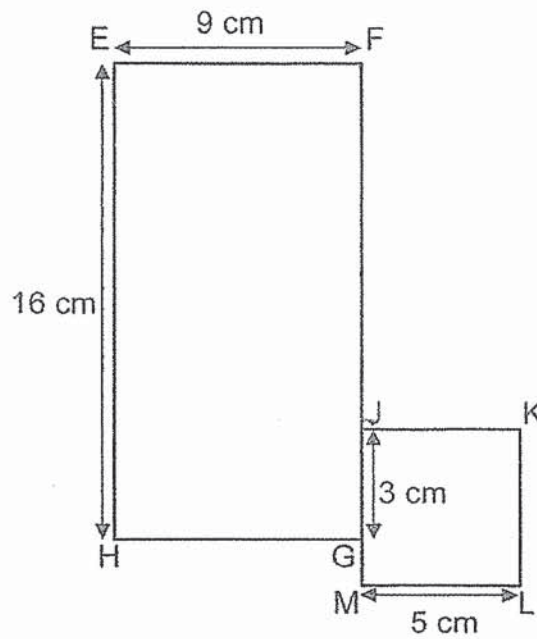

Figure D

- (1) 1
- (2) 2
- (3) 3
- (4) 4

12 The figure below is made up of rectangle EFGH and square JKLM. Find the sum of the length FJ and GM.



- (1) 15 cm
- (2) 18 cm
- (3) 21 cm
- (4) 25 cm

- 13 PQRS is a rectangle with its length thrice as long as its breadth as shown below. Find the length of rectangle PQRS given that its perimeter is 120 cm.

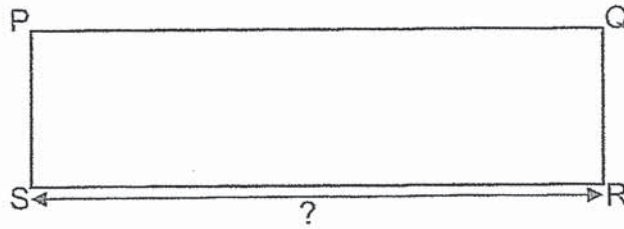

- (1) 15 cm
  - (2) 30 cm
  - (3) 45 cm
  - (4) 90 cm
- 14 A picture is mounted on a frame measuring 24 cm by 16 cm. It has a border of 4 cm around it. Find the area of the picture.

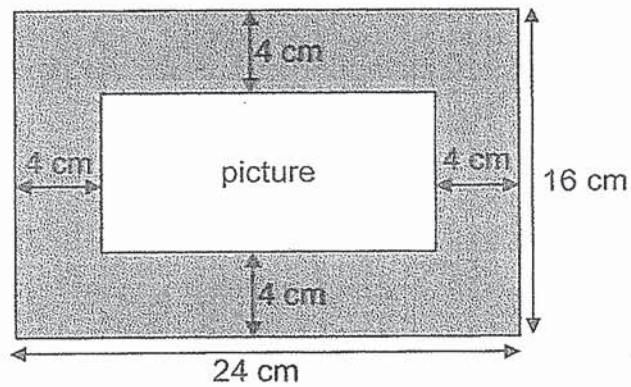

- (1) 48 cm<sup>2</sup>
- (2) 128 cm<sup>2</sup>
- (3) 240 cm<sup>2</sup>
- (4) 384 cm<sup>2</sup>



- 15 The scale below shows the mass of two identical wooden blocks. Find the mass of one wooden block.

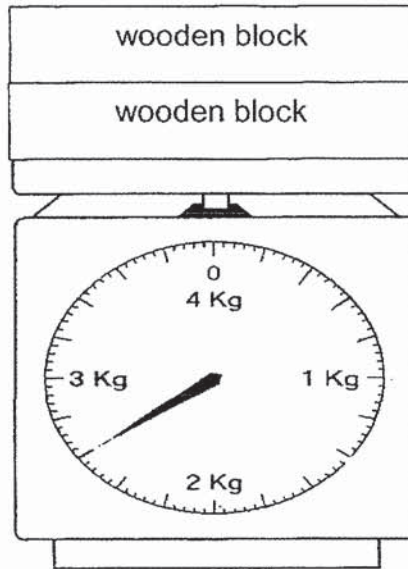

- (1) 1.15 kg  
(2) 1.3 kg  
(3) 2.3 kg  
(4) 2.6 kg
- 16 Muthu wanted to buy two shirts that cost \$25.65 each, but he was short of \$14.20. How much money did Muthu have?
- (1) \$11.45  
(2) \$37.10  
(3) \$39.85  
(4) \$65.50
- 17 A machine took 36 minutes to make a box. Mr Ahmad turned on the machine to make 4 boxes continuously. At 5.30 p.m., he turned off the machine after it had made 4 boxes. What time did he turn on the machine?
- (1) 15 06  
(2) 15 46  
(3) 19 14  
(4) 19 54

- 18 The picture below shows a map of XYZ Neighbourhood.

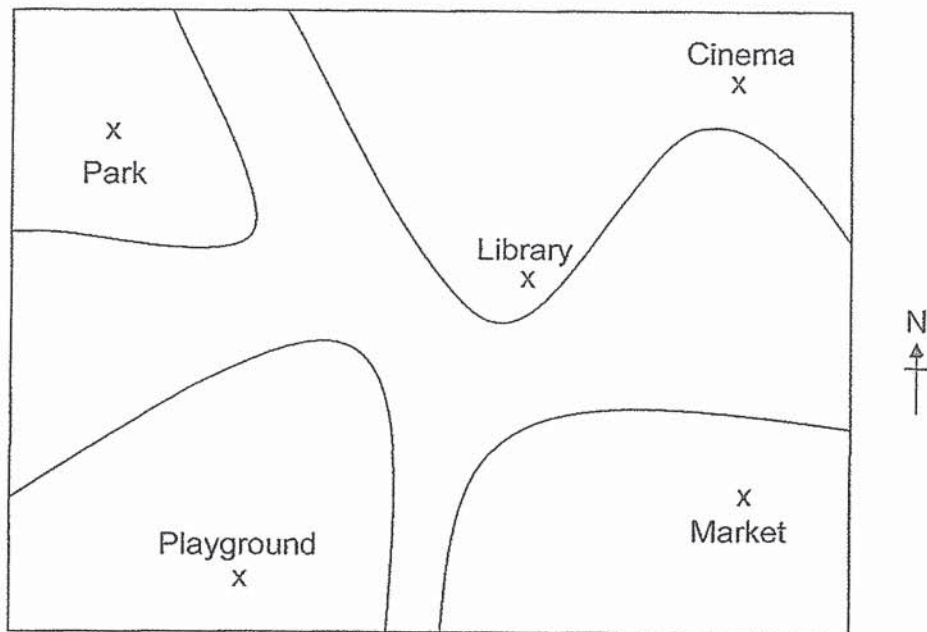

The library is north-east of the \_\_\_\_\_.

- (1) cinema
  - (2) market
  - (3) park
  - (4) playground
- 19 Xavier, Yan Li and Zoe shared 1400 cards. Xavier had 200 fewer cards than Yan Li and twice as many cards as Zoe. How many cards did Xavier have?
- (1) 240
  - (2) 300
  - (3) 480
  - (4) 640



20 Vivian is standing at A facing south-west.

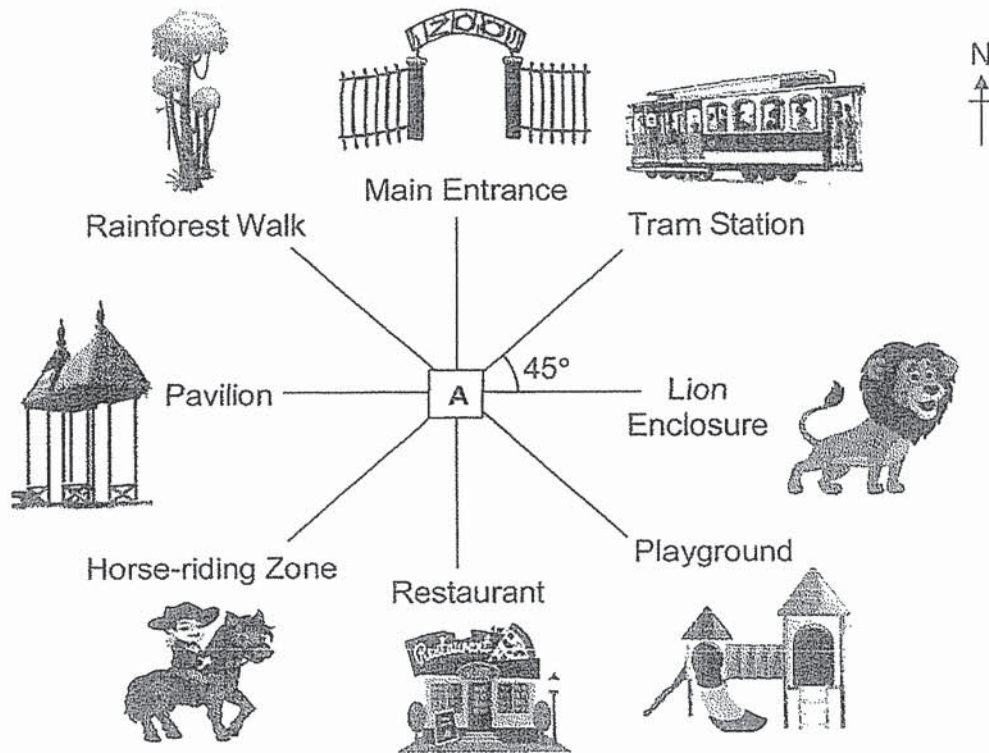

Vivian turns through an angle of  $225^\circ$  in an anti-clockwise direction. Then, she makes a \_\_\_\_\_ in the clockwise direction to face the lion enclosure.

- (1)  $\frac{1}{4}$ -turn
- (2)  $\frac{1}{2}$ -turn
- (3)  $\frac{3}{4}$ -turn
- (4) 1 complete turn



# RED SWASTIKA SCHOOL

## 2020 SEMESTRAL ASSESSMENT 2

### MATHEMATICS

Name : \_\_\_\_\_ ( )

Class : Primary 4 / \_\_\_\_\_

Date : 29 Oct 2020

### BOOKLET B

28 Questions  
60 Marks

In this booklet, you should have the following:

- (a) Page 9 to Page 21
- (b) Questions 21 to 48

### MARKS

	OBTAINED	POSSIBLE
BOOKLET A		40
BOOKLET B		60
TOTAL		100

Parent's Signature : \_\_\_\_\_

Questions 21 to 30 carry 1 mark each. Questions 31 to 40 carry 2 marks each. Show your working clearly in the space below each question and write your answers in the spaces provided. For questions which require units, give your answers in the units stated.

(30 marks)

- 21 The perimeter of a square is 24 cm. What is its length?

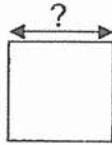

Ans: \_\_\_\_\_ cm

- 22 You are given four number cards.

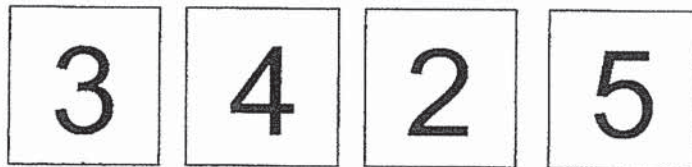

Arrange the cards to form the greatest 4-digit odd number.

Ans: \_\_\_\_\_

- 23 Tom drew four lines as shown below. Measure the marked angle  $\angle QRS$ .

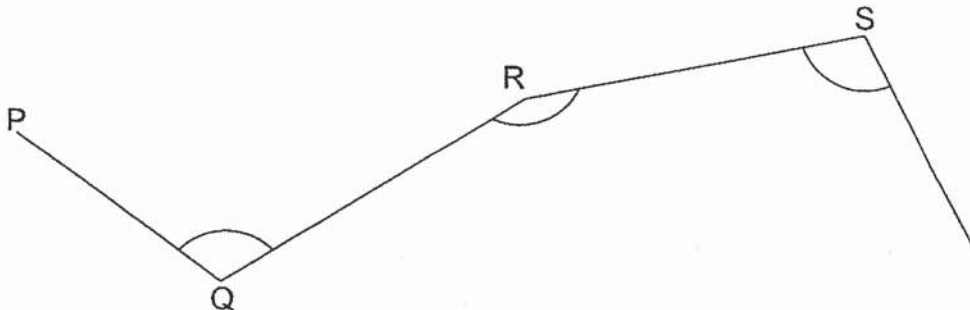

Ans: \_\_\_\_\_ °

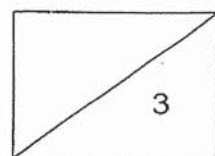

The line graph below shows the amount of money Siti saved at the end of each month from July to November. Study the graph carefully and use it to answer Questions 24 to 26.

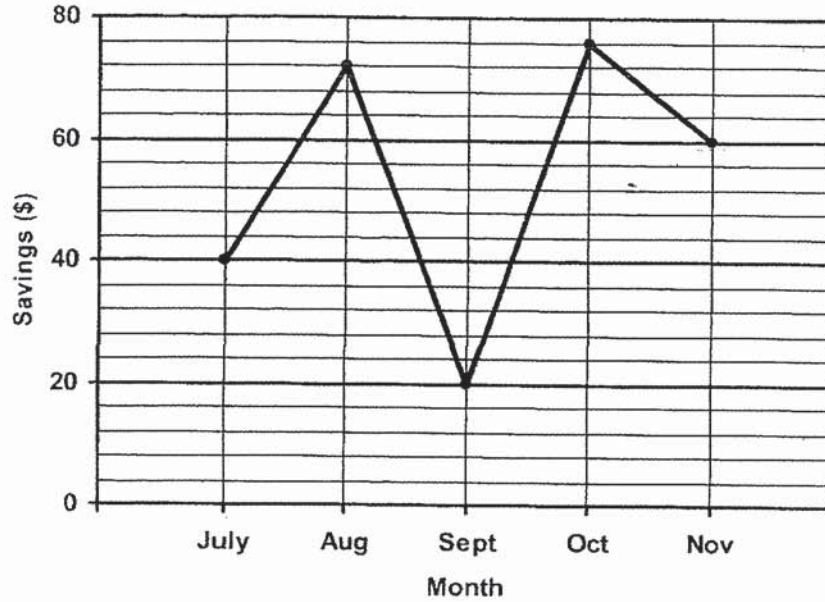

24 Find the sum of Siti's saving in July and August.

Ans: \$ \_\_\_\_\_

---

25 Which month did she save thrice as much as September?

Ans: \_\_\_\_\_

---

26 What was the difference between Siti's highest and the lowest savings recorded on the graph?

Ans: \$ \_\_\_\_\_

---

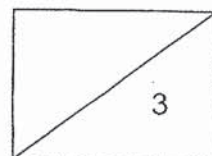

- 27 The table below shows the number of people who attended an event last weekend.

		Number of people
Male	Boys	15
	Men	18
Female	Girls	<del>25</del>
	Women	25

$\frac{1}{2}$  of the people who attended the event were adults. Find the number of girls who attended the event.

Ans: \_\_\_\_\_

- 28 In the figure below, all the lines meet at right angle. Find the perimeter of the figure.

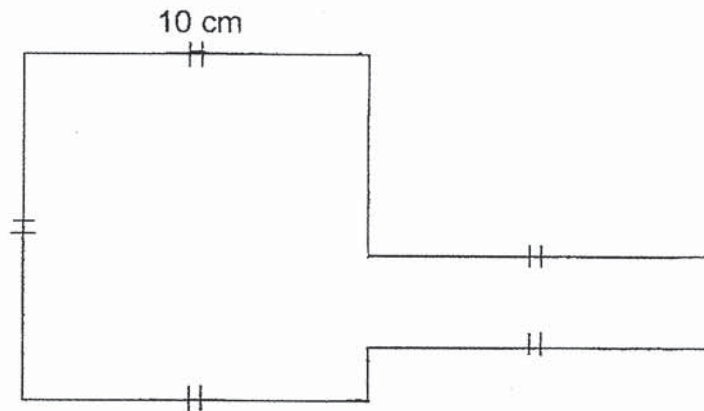

Ans: \_\_\_\_\_ cm

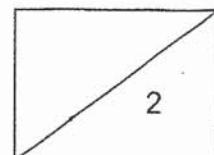



- 29 Jason's clock is 25 minutes slow. After spending 30 minutes on painting, the time on his clock was 11.15 a.m. What was the actual time he started painting?

Ans: \_\_\_\_\_ a.m.

- 30 Two rectangular mats, each 4 m by 6 m are placed on the floor as shown below. The mats overlap and the area of the floor covered by the overlap is  $8.4 \text{ m}^2$ . Find the length of AB.

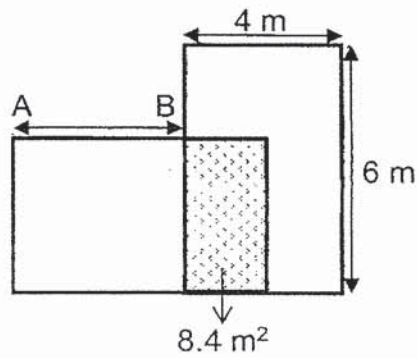

Ans: \_\_\_\_\_ m

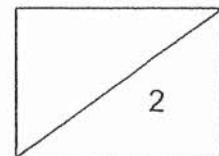



31 Write eleven thousand and thirty-four in figures.

Ans: \_\_\_\_\_

---

32 Find the product of 2150 and 3.

Ans: \_\_\_\_\_

---

33 Two factors of 10 are 1 and 10. What are the other two factors of 10?

Ans: \_\_\_\_\_ and \_\_\_\_\_

---

34 What is the value of  $\frac{5}{6} + \frac{2}{3}$ ?  
Express your answer as a mixed number.

Ans: \_\_\_\_\_

---

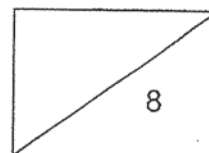

35 Which two of the fractions below are smaller than  $\frac{1}{2}$  ?

$$\frac{2}{5}, \frac{3}{6}, \frac{4}{7}, \frac{5}{12}$$

Ans: \_\_\_\_\_ and \_\_\_\_\_

---

36 In the figure shown, PQRS is a rectangle. Find  $\angle TSU$ .

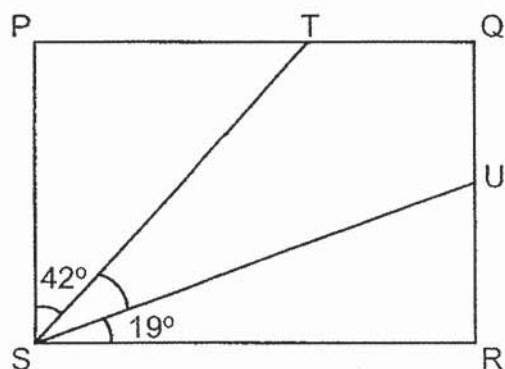

Ans: \_\_\_\_\_ °

---

37  $5.4 - 0.68 =$  \_\_\_\_\_

Ans: \_\_\_\_\_

---

38 Arrange the following numbers in order from the greatest to the smallest.

0.052, 0.205, 0.502

Ans: \_\_\_\_\_, \_\_\_\_\_, \_\_\_\_\_  
(greatest) (smallest)

---

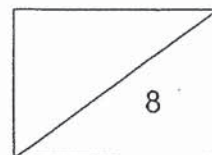

39 Write the decimal represented by A.

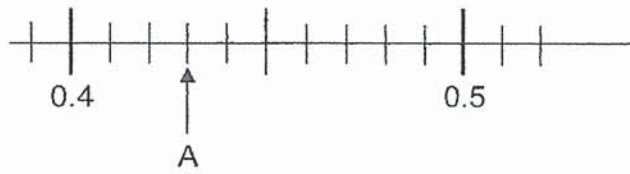

Ans: \_\_\_\_\_

40 Complete the symmetric figure below with XY as the line of symmetry.

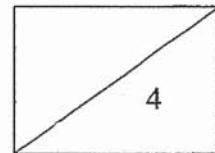
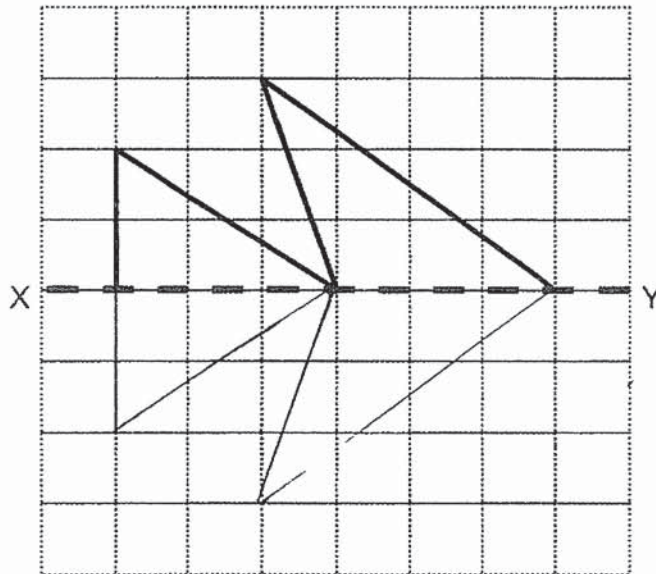

Questions 41 to 48 carry 3 or 4 marks each. Show your working clearly in the space below each question and write your answers in the spaces provided.  
(30 marks)

---

- 41 A box contains red, blue and yellow beads.  $\frac{2}{5}$  of the beads are red. There are 42 blue beads and 18 yellow beads in the box. How many red beads are there in the box?

Ans: \_\_\_\_\_ [3]

---

- 42 Mr Rahim bought 10 muffins and 2 donuts from a bakery. The muffins were sold in packs of 2 for \$3.65 and Mr Rahim paid less than \$20 for all the muffins and donuts bought.
- (a) How much did Mr Rahim pay for the 10 muffins?
- (b) Was a pack of 2 muffins **cheaper** or **more expensive** than the total cost of the 2 donuts?

Ans: (a) \_\_\_\_\_ [3]

(b) \_\_\_\_\_ [1]

---

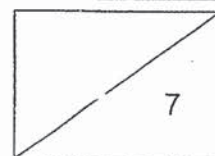

- 43 A tank was partly filled with water at first. A tap was then turned on for 30 minutes to fill the tank completely. The line graph shows the volume of water in the tank at regular intervals of time for 40 minutes.

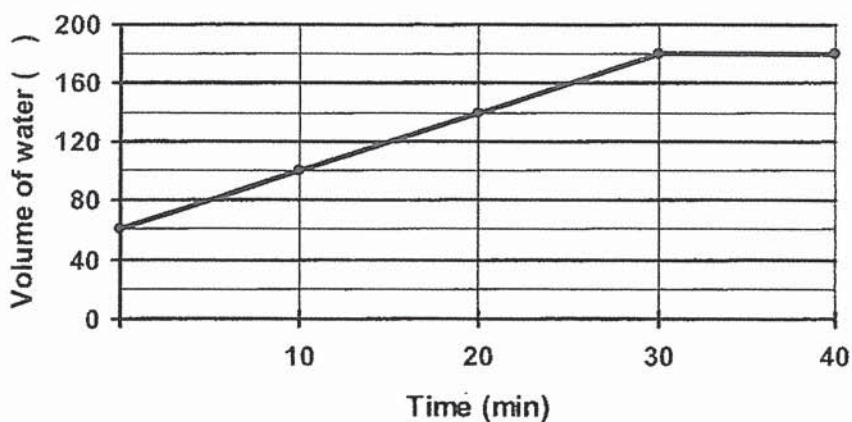

- (a) How many litres of water were there in the tank at first?
- (b) How many litres of water was added into the tank between the 10<sup>th</sup> and 30<sup>th</sup> minute?
- (c) The bar graph below shows the amount of water in the tank from the 20<sup>th</sup> to 30<sup>th</sup> minute. Draw the bar representing the amount of water in the tank at the 40<sup>th</sup> minute in the bar graph below.

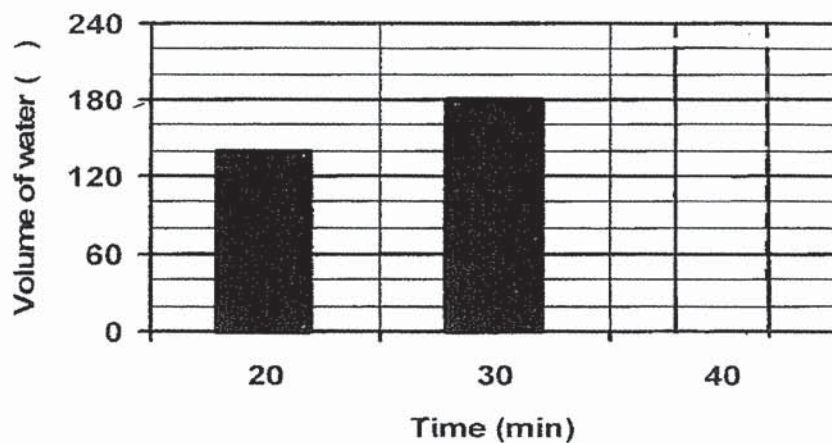

[1]

Ans: (a) \_\_\_\_\_ [1]

(b) \_\_\_\_\_ [2]

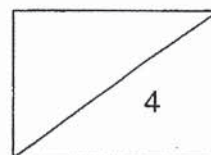

44 Leon bought 5.85 kg of flour. He used  $\frac{4}{5}$  of it to bake some cakes.

- (a) Find the mass of flour he had left in kilograms.
- (b) Leon then repacked the remaining flour equally into 6 packets. What is the mass of the flour in each packet in kilograms?

Ans: (a) \_\_\_\_\_ [2]

(b) \_\_\_\_\_ [2]

45 4 identical rectangles are arranged as shown below. XY is 13 cm and the unshaded area Square ABCD is  $81 \text{ cm}^2$ . Find the breadth of the rectangle.

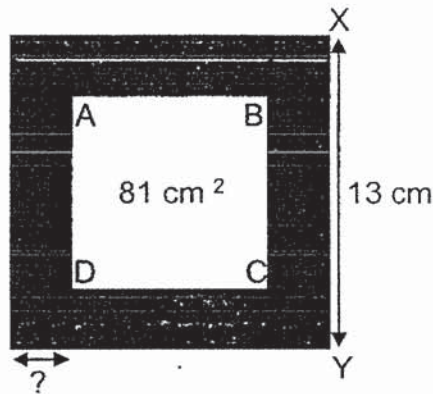

Ans: \_\_\_\_\_ [3]

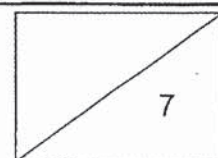



- 46 Ali uses sticks to form figures that follow a pattern. The first five figures are shown below.

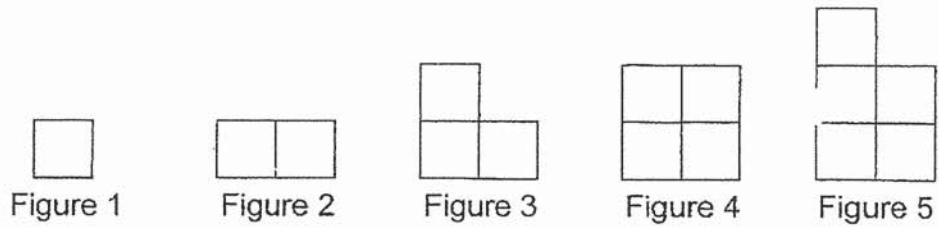

- (a) The table below shows the number of sticks used for each figure. Complete the table for Figure 6 and Figure 7.

Figure Number	Number of sticks used
1	4
2	7
3	10
4	12
5	15
6	
7	

[2]

- (b) What is the difference in the number of sticks Ali would use for Figure 9 and Figure 11?
- (c) In which figure number would Ali use 40 sticks?

Ans: (b) \_\_\_\_\_ [1]

(c) \_\_\_\_\_ [1]

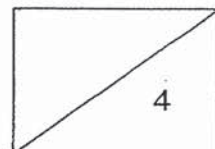

47 Hazel had 80 more stickers than Jun Ming. Hazel gave 85 stickers to Jun Ming. In the end, Jun Ming had thrice as many stickers as Hazel.

(a) How many stickers did Hazel had in the end?

(b) How many stickers did Jun Ming had at first?

Ans: (a) \_\_\_\_\_ [2]

(b) \_\_\_\_\_ [2]

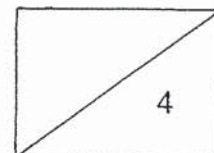

48 Mrs Tan had  $5\frac{4}{9}$  m of blue ribbon,  $5\frac{2}{3}$  m of red ribbon and  $6\frac{1}{3}$  m of green ribbon.

- (a) Find the difference between the length of the longest and the shortest ribbon Mrs Tan had.
- (b) Mrs Tan then used an equal length of the blue and red ribbon to tie a present.

Each statement below is either true, false or not possible to tell from the information given above.

For each statement, put a tick (  $\checkmark$  ) in the correct column.

Statement	True	False	Not possible to tell
After tying the present, Mrs Tan had a longer length of blue ribbon than red ribbon left.			
After tying the present, the length of the red ribbon was twice the length of the blue ribbon left.			

[2]

Ans: (a) \_\_\_\_\_ [2]

End of Paper

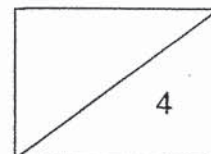

# ANSWER KEY

YEAR : 2020

LEVEL : PRIMARY 4

SCHOOL : RED SWASTIKA SCHOOL

SUBJECT : MATHEMATICS

TERM : SA2

## BOOKLET A

Q1	4	Q2	2	Q3	3	Q4	4	Q5	4
Q6	1	Q7	3	Q8	1	Q9	3	Q10	2
Q11	1	Q12	1	Q13	3	Q14	2	Q15	2
Q16	2	Q17	1	Q18	4	Q19	3	Q20	1

## BOOKLET B

Q21	6cm
Q22	5423
Q23	159°
Q24	\$112
Q25	November
Q26	\$56
Q27	25+18=43 43×2=86 25+18+15=58 86-58=28
Q28	60cm
Q29	11.10 a.m.
Q30	8.4÷4=2.1 6-2.1=3.9
Q31	11034
Q32	6450
Q33	2 and 5
Q34	$1\frac{1}{2}$
Q35	$\frac{2}{5}$ and $\frac{5}{12}$
Q36	29°
Q37	4.72

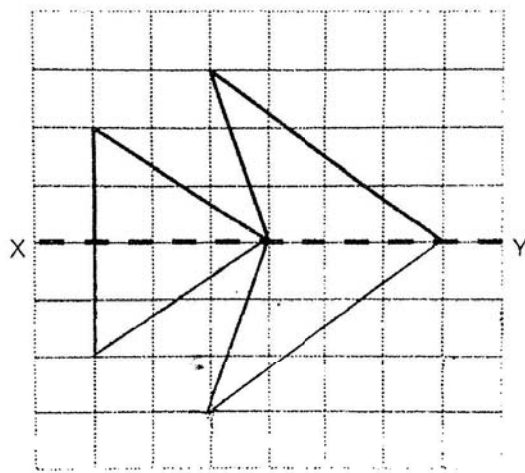
Q38	0.502 , 0.205 , 0.052																
Q39	0.43																
Q40																	
Q41	$42+18=60$ $60\div 3=20$ $20\times 4=40$																
Q42	a) $10\div 2=5$ $3.65\times 5=18.25$ b) more expensive																
Q43	a) 60L b) $140-100=40$ $180-140=40$ $40+40=80L$																
Q44	a) $5.85\div 5=1.17\text{kg}$ b) $1.17\div 6=0.195\text{kg}$																
Q45	$9\times 9=81$ $13-9=4$ $4\div 2=2\text{cm}$																
Q46	<table border="1" data-bbox="319 1523 1340 1881"> <thead> <tr> <th>Figure</th> <th>Number of sticks used</th> </tr> </thead> <tbody> <tr> <td>1</td> <td>4</td> </tr> <tr> <td>2</td> <td>7</td> </tr> <tr> <td>3</td> <td>10</td> </tr> <tr> <td>4</td> <td>12</td> </tr> <tr> <td>5</td> <td>15</td> </tr> <tr> <td>6</td> <td>17</td> </tr> <tr> <td>7</td> <td>20</td> </tr> </tbody> </table> b) $30-25=5$ c) 15	Figure	Number of sticks used	1	4	2	7	3	10	4	12	5	15	6	17	7	20
Figure	Number of sticks used																
1	4																
2	7																
3	10																
4	12																
5	15																
6	17																
7	20																
Q47	a) $5+5=10$																



	$80+10=90$ $90\div 2=45$ <b>b) <math>45+5=50</math></b>			
Q48	<b>a)</b>			
	<b>Statement</b>	<b>True</b>	<b>False</b>	<b>Not possible to tell</b>
	After tying the present, Mrs Tan had a longer length of blue ribbon than red ribbon left.		✓	
	After tying the present, the length of the red ribbon was twice the length of the blue ribbon left.			✓
	<b>b) <math>\frac{8}{9}m</math></b>			

**KIASU**  
ExamPaper  
Islandwide Delivery | Whatsapp Only 88660031



3  
END.