



Maha Bodhi School
2020 Semestral Assessment 2
Primary 4
Mathematics
Booklet A

Name : _____ ()

Class : Primary 4 _____

Date : 3 November 2020

Total Duration for Booklets A and B: 1 h 45 min

INSTRUCTIONS TO CANDIDATES:

1. Do not turn over this page until you are told to do so.
2. Follow all instructions carefully.
3. Answer all questions.
4. Shade your answers in the Optical Answer Sheet (OAS) provided.

This booklet consists of 10 printed pages.

Section A (40 marks)

Questions 1 to 20 carry 2 marks each.

For each question, four options are given. One of them is the correct answer.

Make your choice (1, 2, 3 or 4) and shade your answer on the Optical Answer Sheet.

1. 22 thousands and 3 tens is the same as _____.

- (1) 223
- (2) 2230
- (3) 22 003
- (4) 22 030

2. 25 679 rounded to the nearest hundred is _____.

- (1) 25 600
- (2) 25 680
- (3) 25 700
- (4) 26 000

3. The figure shown is made up of identical squares. What fraction of the figure is shaded?



(1) $\frac{2}{5}$

(2) $\frac{3}{7}$

(3) $\frac{3}{10}$

(4) $\frac{7}{10}$

4. Arrange the following fractions from the greatest to the smallest.

$$\frac{3}{4}, \frac{1}{6}, \frac{7}{12}$$

(greatest) (smallest)

(1) $\frac{1}{6}, \frac{3}{4}, \frac{7}{12}$

(2) $\frac{7}{12}, \frac{1}{6}, \frac{3}{4}$

(3) $\frac{7}{12}, \frac{3}{4}, \frac{1}{6}$

(4) $\frac{3}{4}, \frac{7}{12}, \frac{1}{6}$

5. In the number 46.28, the digit _____ is in the tenths place.

(1) 6

(2) 2

(3) 8

(4) 4

6. Which of the following figures in the square grid below has both parallel lines and perpendicular lines?

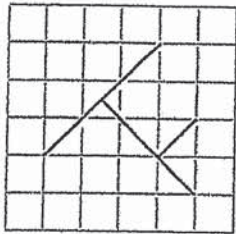

(1)

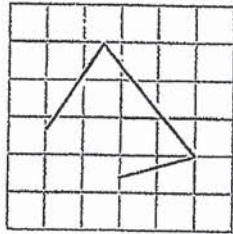

(2)

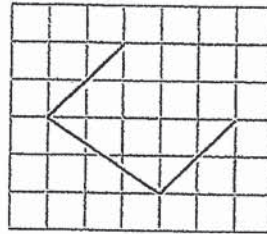

(3)

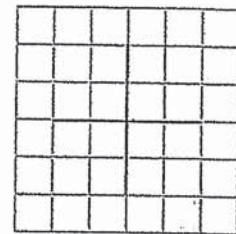

(4)

7. The area of a square is 36 cm^2 . What is the length of one side of the square?

(1) 18 cm

(2) 12 cm

(3) 9 cm

(4) 6 cm

8. What is the time shown on the clock?

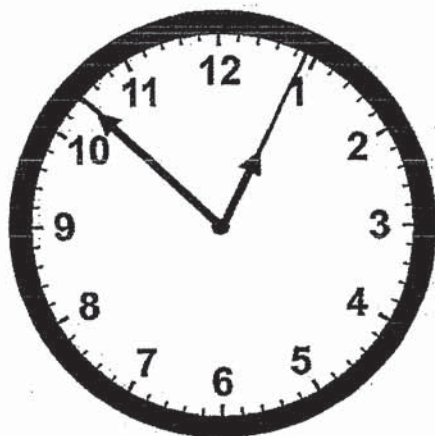

- (1) 10.05 a.m.
- (2) 11.05 a.m.
- (3) 12.52 p.m.
- (4) 1.52 p.m.

9. At a bookshop, a pen cost \$2 each.
A packet of 6 such pens cost \$10.
Wei Wei wanted to buy 19 such pens.
What is the least amount of money she has to pay?

- (1) \$12
- (2) \$30
- (3) \$32
- (4) \$38

10. $\frac{1}{10}$ of a pole was painted blue.

$\frac{1}{2}$ of the pole was painted yellow and the rest was painted red.

The part painted red was 48 cm long. How long was the part of the pole painted blue?

(1) 12 cm

(2) 24 cm

(3) 60 cm

(4) 72 cm

11. Lina and Kimberly each baked a cake.
Lina's cake was 0.6 kg heavier than Kimberly's cake.
The total mass of their cakes was 3.2 kg.
What was the mass of Lina's cake?

(1) 3.8 kg

(2) 2.6 kg

(3) 1.9 kg

(4) 1.3 kg

12. Ryan was standing at point X, facing south-east at first.
He then turned 225° in the clockwise direction.
Where was he facing in the end?

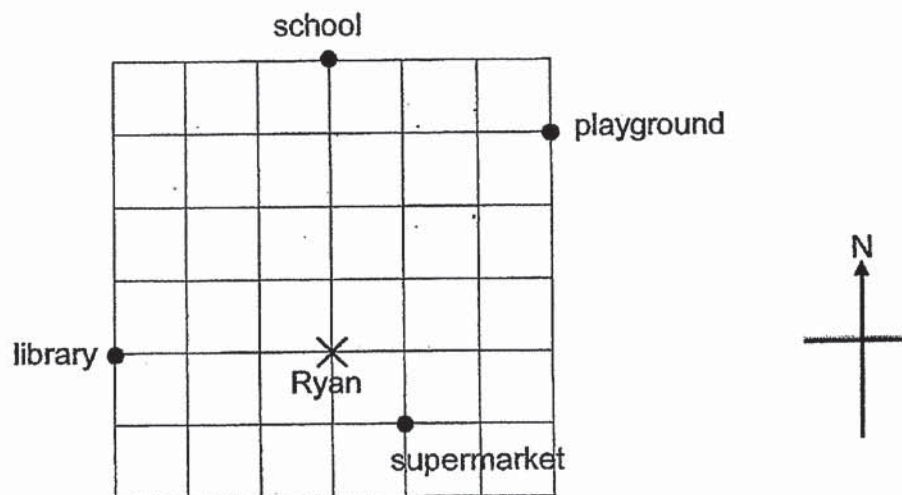

- (1) library
 - (2) school
 - (3) playground
 - (4) supermarket
13. Four letters N, O, S, E are shown below.

N O S E

How many of these letters are symmetric?

- (1) 1
- (2) 2
- (3) 3
- (4) 4

14. ABCD is a square that is formed by 2 identical rectangles and 2 identical squares. The perimeter of ABCD is 160 cm. Find the breadth of each rectangle.

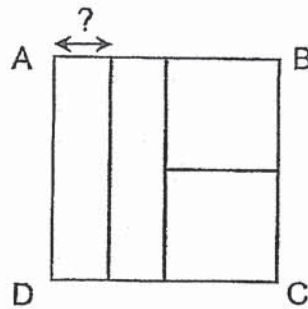

- (1) 10 cm
 (2) 20 cm
 (3) 40 cm
 (4) 80 cm
15. Find the area of the figure shown below.

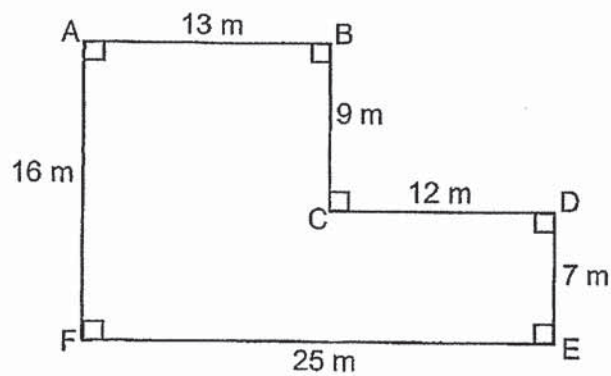

- (1) 208 m²
 (2) 292 m²
 (3) 383 m²
 (4) 400 m²

16. The bar graph shows the number of paper aeroplanes that five boys folded.

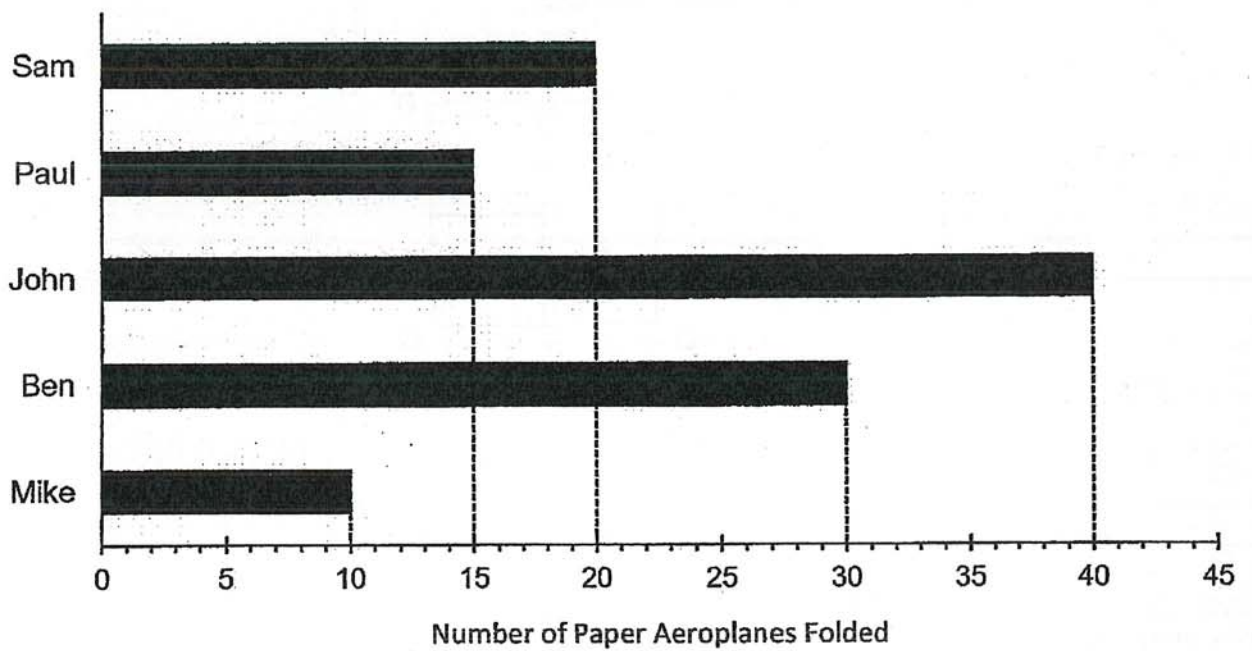

Sam folded twice as many paper aeroplanes as _____.

- (1) Paul
 - (2) John
 - (3) Ben
 - (4) Mike
17. Joseph is thinking of 2 numbers.
The only common factors of both numbers are 1 and 2.
Their first common multiple is 24. One of the numbers is 8.
What is the other number?

- (1) 12
- (2) 2
- (3) 6
- (4) 4

18. How many **unshaded** circles need to be removed so that $\frac{1}{5}$ of the remaining circles are shaded?

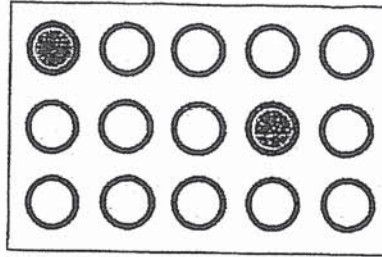

- (1) 1
(2) 5
(3) 3
(4) 10
19. Ropes A, B and C have a total length of 57.1 m.
The total length of Ropes A and B is 31.4 m.
The total length of Ropes A and C is 39.2 m.
What is the length of Rope A?
- (1) 13.5 m
(2) 17.9 m
(3) 25.7 m
(4) 70.6 m

20. WXYZ is made up of a square and a rectangle.
The area of the square is 25 cm^2 .
The length of the rectangle is twice its breadth.
Find the perimeter of WXYZ.

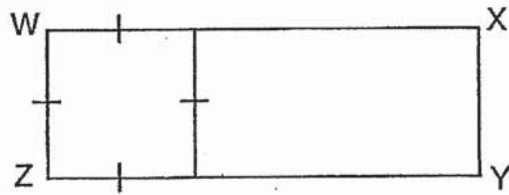

- (1) 10 cm
- (2) 20 cm
- (3) 40 cm
- (4) 50 cm



Remember to check your work!

~ End of Booklet A ~

This is the property of Maha Bodhi School.
No part of this should be duplicated without the permission of Maha Bodhi School.



Maha Bodhi School
2020 Semestral Assessment 2
Primary 4
Mathematics
Booklet B

Name : _____ ()

Class : Primary 4 _____

Date : 3 November 2020

Total Duration for Booklets A and B: 1 h 45 min

INSTRUCTIONS TO CANDIDATES:

Do not turn over this page until you are told to do so.

Follow all instructions carefully.

Answer all questions.

Write your answers in this booklet.

Booklet	Marks Obtained	Max Marks
A		40
B		60
Total		100

Parent's signature: _____

This booklet consists of 12 printed pages.

Section B (40 marks)

Questions 21 to 40 carry 2 marks each.

Show your working clearly and write your answers in the spaces provided.

For questions which require units, give your answers in the units stated.

21. Write thirteen thousand and twenty-five in numerals.

Ans: _____

22. Fill in the blank with the correct number in the number pattern below.

875, 850, 825, 800, _____, 750

Ans: _____

23. Two factors of 10 are 1 and 10. What are the other two factors of 10?

Ans: _____ and _____

24. Write $\frac{24}{5}$ as a mixed number in its simplest form.

Ans: _____

25. $\frac{3}{4} + \frac{1}{8} =$ _____.

Ans: _____

26. Round 11.63 to the nearest whole number.

Ans: _____

27. Express $\frac{82}{100}$ as a decimal.

Ans: _____

28. $10.95 + 2.17 =$ _____.

Ans: _____

29. ABCD is a rectangle. Find $\angle x$.

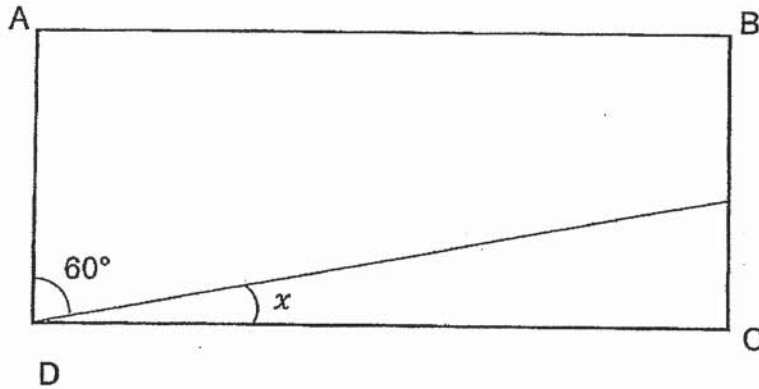

Ans: _____^o

30. The graph below shows the number of books some children borrowed from the library over 5 days.

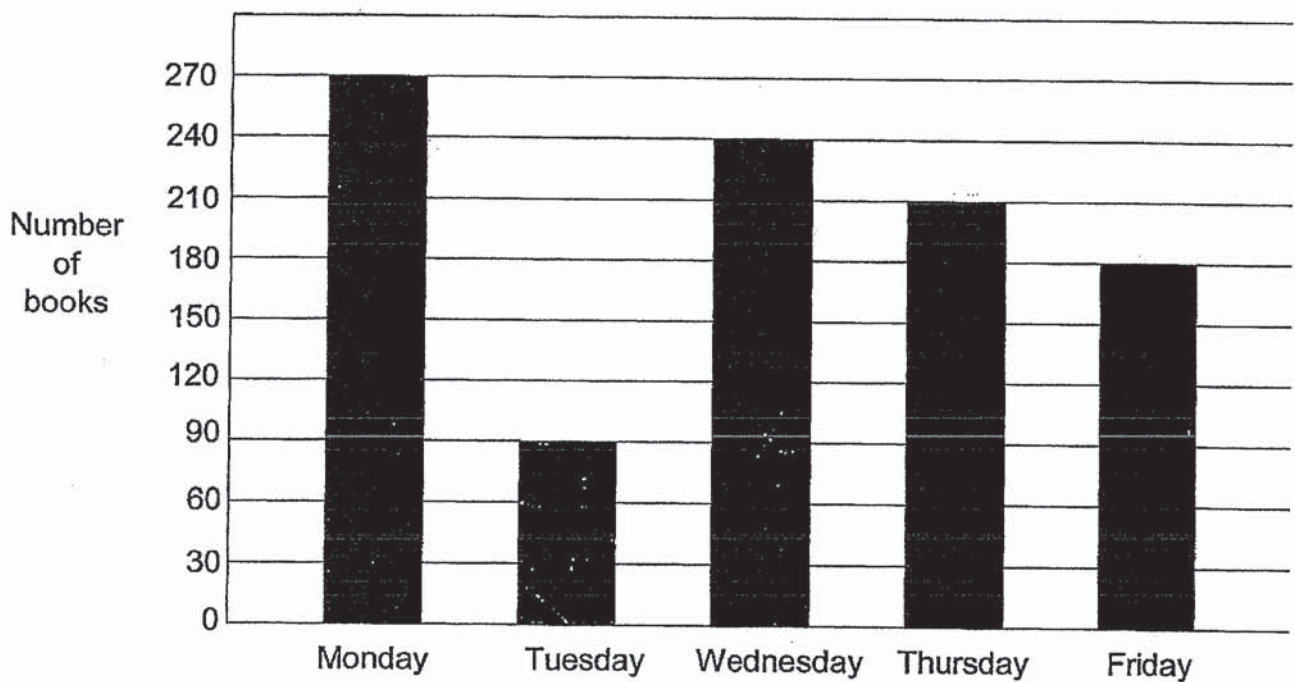

How many books did the children borrow on Wednesday and Friday altogether?

Ans: _____ books

31. The third multiple of a number is 21. What is the number?

Ans: _____

32. Mrs Tan has more than 30 sweets but less than 40 sweets.
She is able to give an equal number of sweets to 4 or 6 children without any remainder.
How many sweets does Mrs Tan have?

Ans: _____ sweets

33. The total mass of Mr Han and his daughter is 91.2 kg.
His mass is 3 times as much as his daughter's mass.
Find the mass of Mr Han.

Ans: _____ kg

34. WXYZ and PQRS are squares.
Find the sum of $\angle XWY$ and $\angle WQX$.

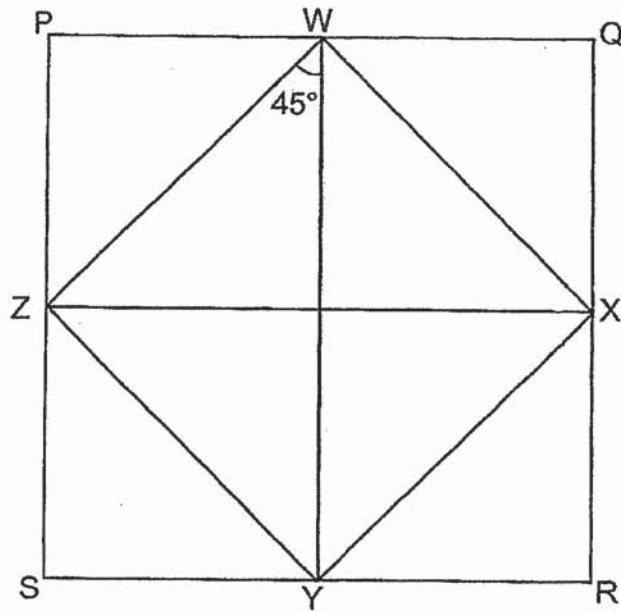

Ans: _____°

35. Shade two squares so that AB is a line of symmetry of the figure.

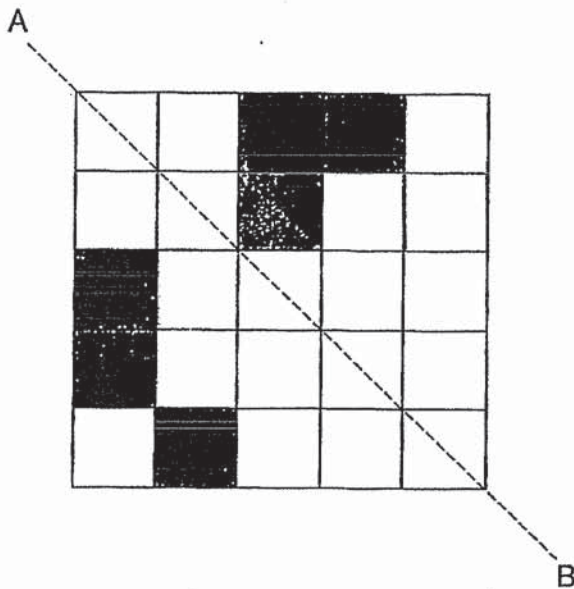

36. Ismail uses circles to form figures that follow a pattern.
The first five figures are shown below.

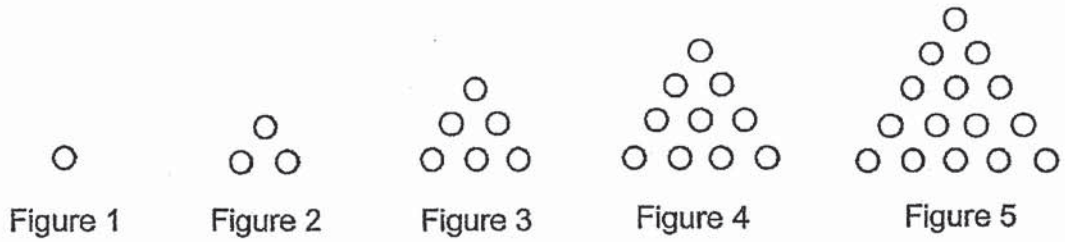

How many circles would he use for Figure 10?

Ans: _____ circles

37. Mrs Rajoo bought the same number of pens and pencils.
After she gave 5 pencils to Ali, she had twice as many pens as pencils left.
She then bought another 18 pens. How many pens did she have in the end?

Ans: _____ pens

38. Lisa had some stickers at first. She gave $\frac{4}{5}$ of them to her friends.
She then bought another 24 stickers. She had 45 stickers in the end.
How many stickers did Lisa have at first?

Ans: _____ stickers

39. Tom was standing in a field, facing a certain direction at first.
 After he made a $\frac{1}{4}$ - turn clockwise followed by a 315° turn anti-clockwise, he faced north.
 Which direction was he facing at first?



Ans: _____

40. ABCD is a square wall.
 Mr Ho painted part of the wall in grey as shown below.
 AB is 3 times as long as AE. EB = 6 m.
 Find the area of the painted part of the wall, AEFD.

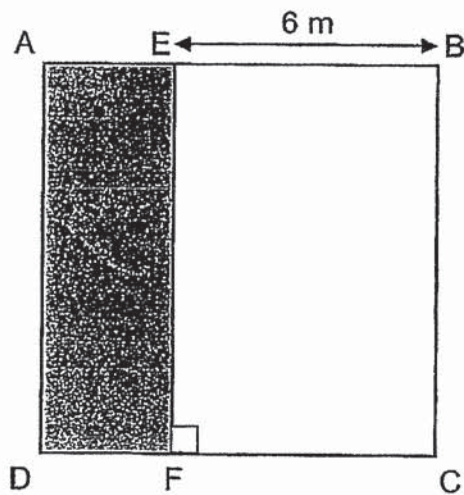

Ans: _____ m^2

Section C (20 marks)

Questions 41 to 45 carry 4 marks each.

Show your working clearly in the space provided for each question and write your answers in the spaces provided. For questions which require units, give your answers in the units stated. The number of marks available is shown in brackets [] at the end of each question or part-question.

41. Mr Lim and Mr Tan have 390 tiles altogether.
Mr Lim has 5 times as many tiles as Mr Tan.
How many more tiles does Mr Lim have than Mr Tan?

Ans: _____ [4]

42. The capacity of a flask is $\frac{5}{8}$ l.

The capacity of a bottle is $\frac{1}{3}$ l less than the capacity of the flask.

Find the total capacity of the flask and the bottle.

Give your answer as a fraction in its simplest form.

Ans: _____ [4]

43. Tammy had \$200. She bought a racket that cost \$143.30. She bought three T-shirts with the remaining amount of money. How much did each T-shirt cost?

Ans: _____ [4]

44. On Saturday, Peter rented a bicycle for 2 h 15 min.
He returned the bicycle at 1.00 p.m.
- (a) What time did he start the bicycle rental on Saturday?
 - (b) On Sunday, he rented the same bicycle for 27 min less than on Saturday.
How long did Peter rent the bicycle on Sunday?

Ans: (a) _____ [2]

(b) _____ [2]

45. 2 identical watches and 5 identical clocks cost \$742.05.
Each watch cost twice as much as each clock.
Muthu bought 4 watches. How much did he pay?

Ans: _____ [4]



Remember to check your work!

~ End of Paper ~

/ 4

This is the property of Maha Bodhi School.
No part of this should be duplicated without the permission of Maha Bodhi School.

ANSWER KEY

YEAR: 2020

LEVEL: PRIMARY 4

SCHOOL: MAHA BODI SCHOOL

SUBJECT: MATHEMATICS

TERM: SEMESTRAL ASSESSMENT 2

BOOKLET A

Q1	4	Q2	3	Q3	3	Q4	4	Q5	2
Q6	1	Q7	4	Q8	3	Q9	3	Q10	1
Q11	3	Q12	2	Q13	2	Q14	1	Q15	2
Q16	4	Q17	3	Q18	2	Q19	1	Q20	3

BOOKET B

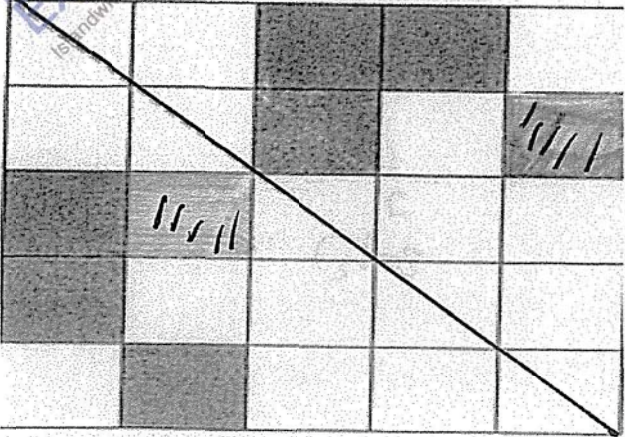
Q21	13025
Q22	775
Q23	2 and 5
Q24	$4\frac{4}{5}$
Q25	$\frac{3}{4} + \frac{1}{8} = \frac{6}{8} + \frac{1}{8} = \frac{7}{8}$
Q26	12
Q27	0.82
Q28	13.12
Q29	$90^\circ - 60^\circ = 30^\circ$
Q30	420 books
Q31	7
Q32	36 sweets
Q33	68.4kg
Q34	$90^\circ + 45^\circ = 135^\circ$
Q35	

Q36	$10+9+8+7+6+5+4+3+2+1=55$ circles
Q37	$5 \times 2 = 10$ $10 + 18 = 28$
Q38	$45 - 24 = 21$ $21 \times 5 = 105$
Q39	South-West
Q40	27
Q41	$390 \div 6 = 65$ $65 \times 4 = 260$ Mr Lim has 260 more tiles.
Q42	$\frac{15}{24} - \frac{8}{24} = \frac{7}{24}$ $\frac{15}{24} = \frac{5}{8} = \frac{22}{24}$ $\frac{22}{24} = \frac{11}{12}$
Q43	$200 - 143.30 = 56.70$ $56.70 \div 3 = 18.90$ Each T-shirt cost \$18.90
Q44	a) The rental started at 10.45 a.m. b) $2\text{h } 15\text{min} - 27\text{min} = 1\text{h } 48\text{min}$ He rented it for 1h 48min
Q45	$742.05 \div 9 = 82.45$ $82.45 \times 2 = 164.90$ $164.90 \times 4 = 659.60$ He paid \$659.60

KIASU
ExamPaper
Islandwide Delivery | Whatsapp Only 88660031

2
8ND