

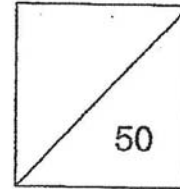

HENRY PARK PRIMARY SCHOOL
MATHEMATICS
PRIMARY 4
Weighted Assessment



Name : _____ ()

Class : P4 _____

Date : 2 July 2020

Duration of Paper: 55 minutes

Parent's Signature: _____

Section A: Multiple Choice Questions (5 x 2 marks = 10 marks)

Read each question carefully. For each question, 4 options are given. One of them is the correct answer. Make your choice (1, 2, 3 or 4). Shade the correct ovals on the Optical Answer Sheet.

1. How many fifths are there in $2\frac{3}{5}$?

- (1) 6
- (2) 10
- (3) 11
- (4) 13

()

2. Which one of the following is a common factor of 18 and 24?

- (1) 9
- (2) 8
- (3) 6
- (4) 4

()

3. What is the size of $\angle ABC$?

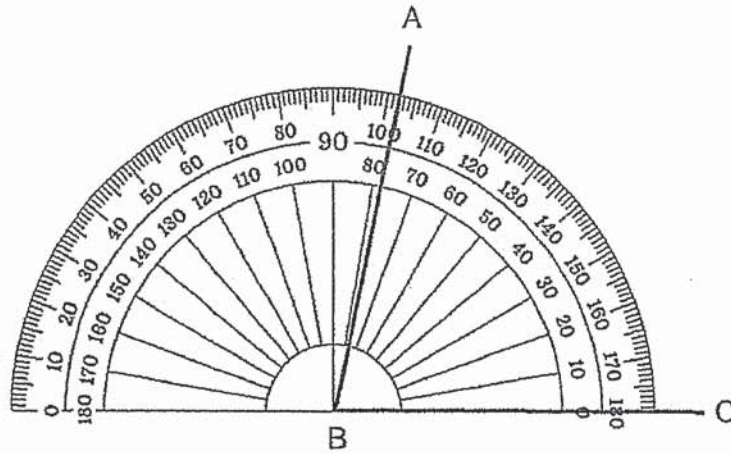

- (1) 78°
- (2) 82°
- (3) 102°
- (4) 118°

()

4. Which one of the following letters has only one line of symmetry?

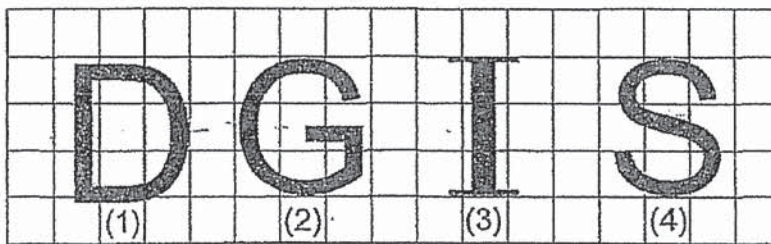

()



5. $\frac{1}{4} + \boxed{?} = \frac{3}{5}$

What is the missing fraction in the box?

(1) $\frac{3}{20}$

(2) $\frac{7}{20}$

(3) $\frac{13}{20}$

(4) $\frac{17}{20}$

()



Section B: Open-Ended Questions (10 x 2 marks = 20 marks)

Read the questions carefully and write the correct answer in the blanks provided. Show all workings clearly.

6. a) Write ninety-eight thousand and fifty-two in numerals.

- b) What is the value of the digit 5 in 65 198?

7. Express $\frac{38}{4}$ as a mixed number in its simplest form.

8. Measure and write down the size of $\angle e$.

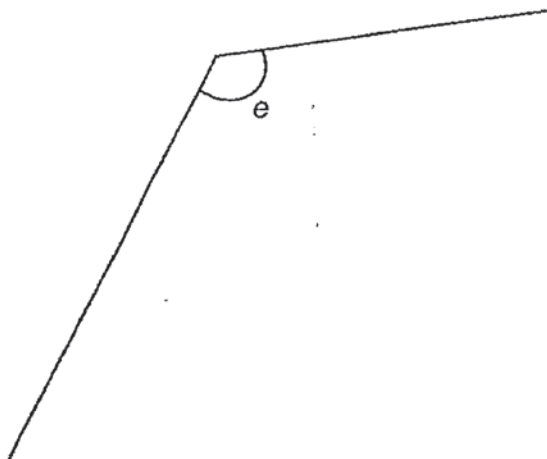

9. PQRS is a square. $\angle TRS$ is 18° . Find $\angle QRT$.

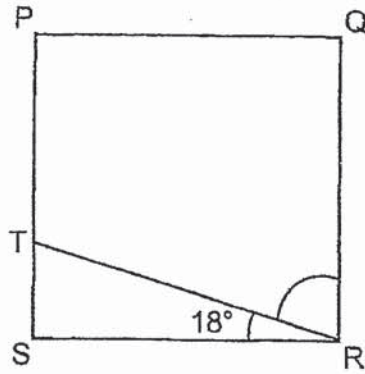

10. Use the digits in the boxes shown below to form the greatest 5-digit even number. Each digit can only be used once.

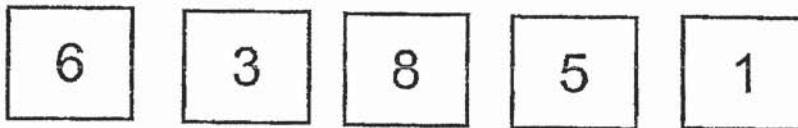

11. Lily had 20 boxes of crayons. There were 12 crayons in each box. She repacked the crayons equally into bags of 8. How many bags of crayons did she have after repacking the crayons?

12. David is standing at Point X and facing the school. What angle will he need to turn in an anti-clockwise direction to face the arcade?

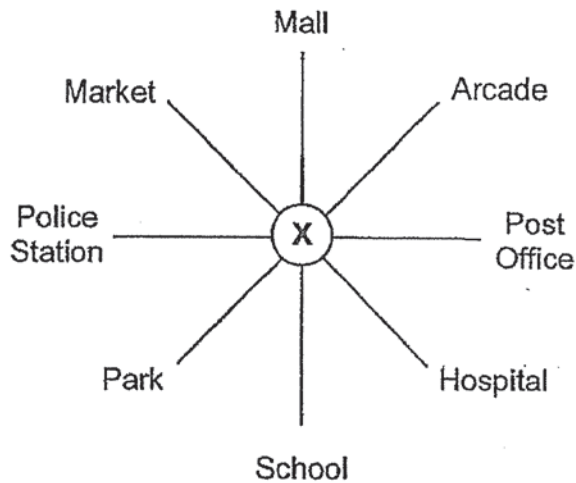

13. In the square grid below, EF and EH are two sides of rectangle EFGH. Complete the drawing of rectangle EFGH.

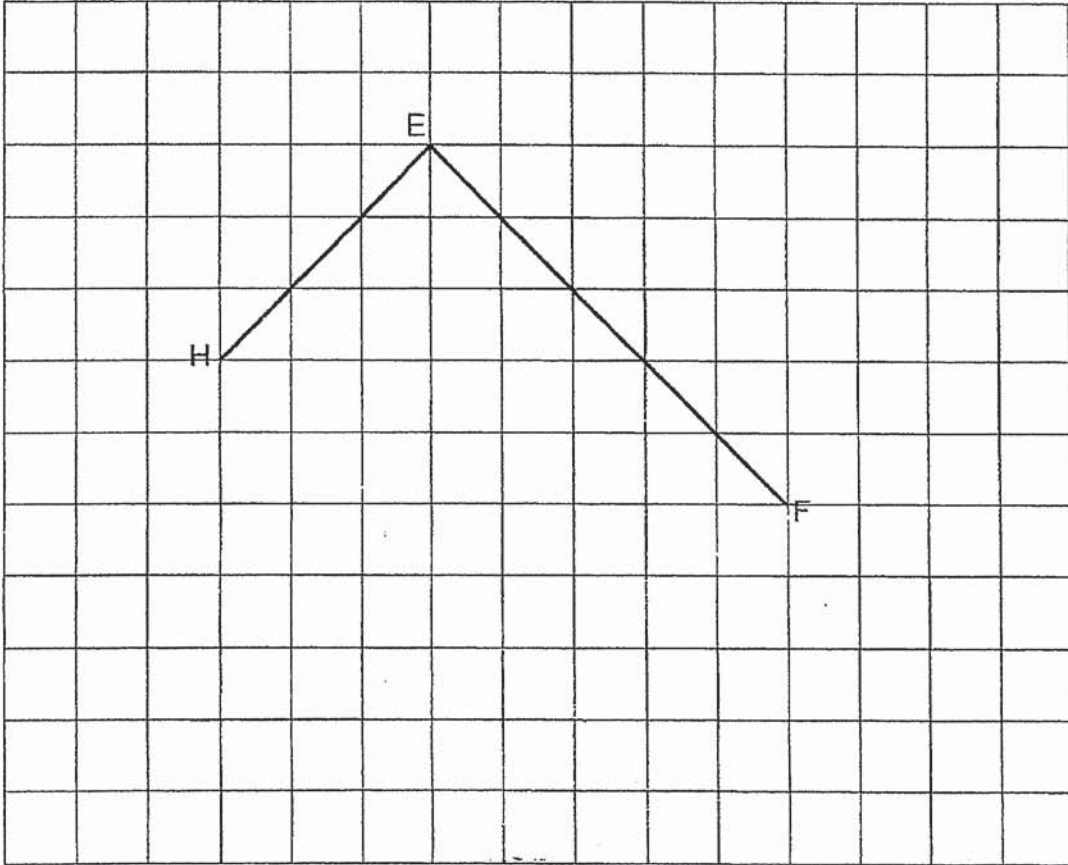

14. The figure below is made up of identical squares. Shade one more square so that line XY is the line of symmetry for the figure.

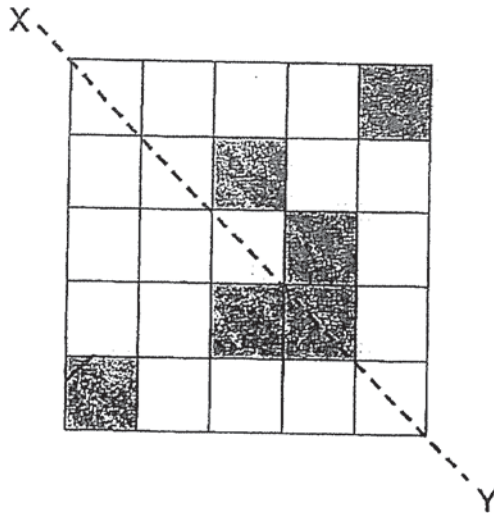

15. There were a total of 150 goats and cows in a farm. After 28 goats and some cows were sold, $\frac{2}{5}$ of the animals were left. How many cows were sold?



Section C: Problem Sums (20 marks)

Read the following problem sums carefully. You may draw models to help you. Show all workings clearly and write your answers in the spaces provided. The number of marks allocated is shown in brackets [] at the end of each question.

16. Mrs Ng has \$372. She wants to buy 1 dress and 2 blouses. Each dress costs twice as much as each blouse. She needs \$44 more to buy all three items.
- a) What is the total cost of 1 dress and 2 blouses?
 - b) How much does each blouse cost?

Ans: a) _____ [2]

b) _____ [2]

17. Aaron and Brandon had a total of 468 cards. Aaron had 86 fewer cards than Brandon at first. Brandon then gave Aaron 38 cards. How many cards does Brandon have now?

Ans: _____ [4]



18. $\frac{3}{7}$ of the pupils in Primary 4 like classical music. $\frac{1}{2}$ of them like pop music. The remaining 23 pupils like rock music.

- a) What fraction of the pupils in Primary 4 like rock music?
- b) How many pupils are there in Primary 4?

Ans: a) _____ [2]

b) _____ [2]



19. At first, Rahul and Pan Pan had the same number of stickers. After Rahul gave away 105 stickers and Pan Pan gave away 45 stickers, Pan Pan had 4 times as many stickers as Rahul. Find the total number of stickers both of them had at first.

Ans: _____ [4]



20. Richard paid \$441 for 6 books and 3 files. Each book cost \$15 more than a file. How much did he pay for the 3 files?

Ans: _____ [4]

- End of Paper -



ANSWER KEY

YEAR : 2020
LEVEL : PRIMARY 4
SCHOOL : HENRY PARK
SUBJECT : MATHEMATICS
TERM : 1A2

SECTION A

Q1	4	Q2	3	Q3	1	Q4	1	Q5	2
----	---	----	---	----	---	----	---	----	---

SECTION B

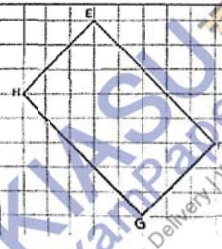
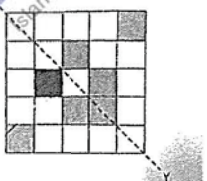
Q6	a) 98052 b) 5000
Q7	$9\frac{1}{2}$
Q8	126°
Q9	$90^\circ - 18^\circ = 72^\circ$
Q10	85316
Q11	$240 \div 8 = 30$
Q12	135°
Q13	
Q14	

Q15	$5u = 150$ $1u = 150 \div 5 = 30$ $3u = 3 \times 30 = 90$ $90 - 28 = 62$
-----	---

SECTION C

Q16	a) $372 + 44 = \$416$ b) $416 \div 4 = \$104$
Q17	$468 - 86 = 382$ $382 \div 2 = 191$ $86 - 38 = 48$ $191 + 48 = 239$
Q18	a) $\frac{1}{14}$ b). $23 \times 4 = 92 + 230 = 322$
Q19	$3u = 105 - 45 = 60$ $1u = 60 \div 3 = 20$ $20 + 105 = 125$ $2 \times 125 = 250$
Q20	$15 \times 6 = 90$ $441 - 90 = 351$ $9u = 351$ $1u = 351 \div 9 = 39$ $3u = 3 \times 39 = \$117$



KIASU
ExamPaper
 Islandwide Delivery | Whatsapp Only 88660031

2
8NA