

**PAYA LEBAR METHODIST GIRLS' SCHOOL (PRIMARY)****END-OF-YEAR EXAMINATION, 2020****PRIMARY THREE****SCIENCE****BOOKLET A****NAME** : \_\_\_\_\_ ( )**CLASS** : P3 \_\_\_\_\_**DATE** : 3 November 2020**TOTAL TIME FOR BOOKLETS A & B: 1 hour and 30 minutes****INSTRUCTIONS TO PUPILS**

DO NOT OPEN THIS BOOKLET UNTIL YOU ARE TOLD TO DO SO.

ANSWER ALL QUESTIONS.

**Section A: Multiple Choice Questions (48 marks)**

For each question from 1 to 24, four options are given. One of them is the correct answer. Make your choice (1, 2, 3 or 4) and shade your answer on the Optical Answer Sheet.

1. David put four live mice in four different containers as shown below. In which of the containers will the mouse stay alive the longest?

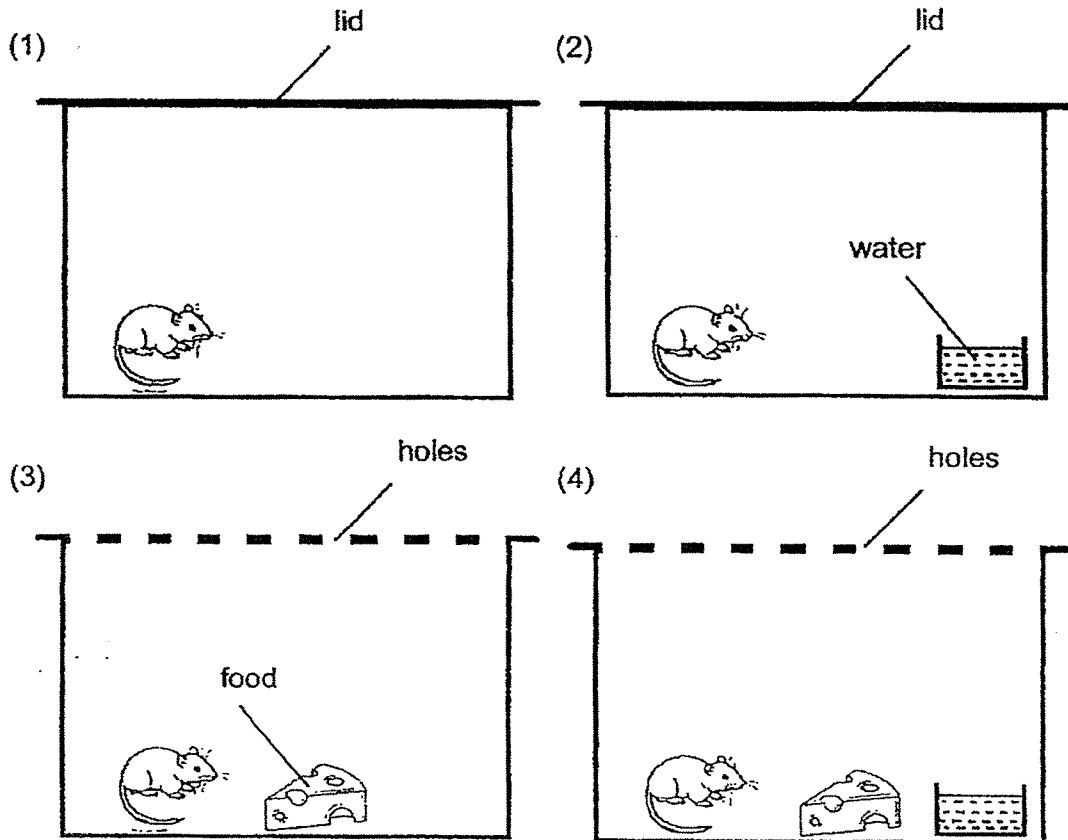

2. Bella saw a tortoise in the park. She touched the tortoise and the tortoise hid in its shell when frightened.

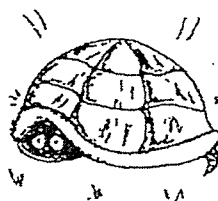

Which one of the following characteristics of living things is shown above?

- (1) Can die
- (2) Can grow
- (3) Can reproduce
- (4) Can respond to changes

3. Study the table below.

Group A	Group B
Bird Nest Fern	Sunflower
Moss	Rose

Which one of the following headings for Group A and Group B are correct?

	Group A	Group B
(1)	Non-flowering plant	Flowering plant
(2)	Non-poisonous plant	Poisonous plant
(3)	Land plant	Water plant
(4)	Strong stem	Weak stem

4. Anna found Animal X in the river.

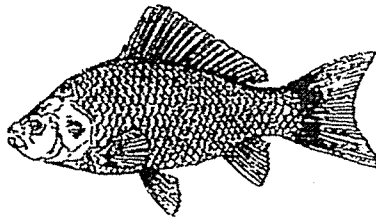

Animal X

Which characteristic can Anna use to tell the animal is a fish?

- (1) It has fins.
- (2) It has a tail.
- (3) It eats plants.
- (4) It lives in water.

5. The picture below shows part X of a face mask which is made of fabric.

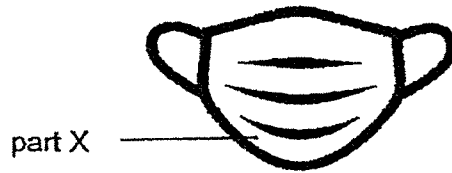

What property of fabric is used to make part X of the face mask?

- (1) It sinks.
  - (2) It is flexible.
  - (3) It breaks easily.
  - (4) It does not allow light to pass through.
6. Janessa wanted to bring a water bottle to school and her mother bought her a plastic bottle instead of a glass bottle.

A plastic bottle is a better choice than a glass bottle because \_\_\_\_\_.

- (1) it can float
  - (2) it is waterproof
  - (3) it does not break easily
  - (4) it allows light to pass through
7. Gina conducted an experiment by dropping two balls, A and B, of different materials into a beaker of water as shown below.

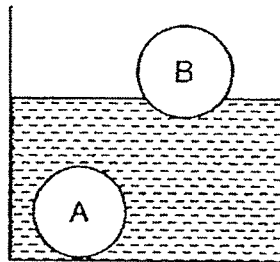

What property of the material of ball A can Gina conclude based on the observation?

- (1) Ball A is waterproof.
- (2) Ball A sinks in water.
- (3) Ball A floats on water.
- (4) Ball A is not waterproof.

8. Which one of the following diagrams shows the correct stages in the life cycle of a non-flowering plant?

(1)

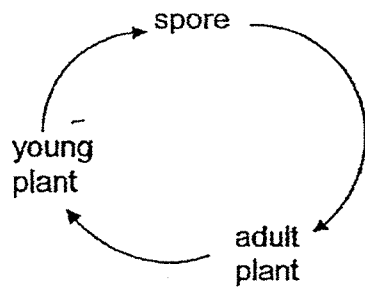

(2)

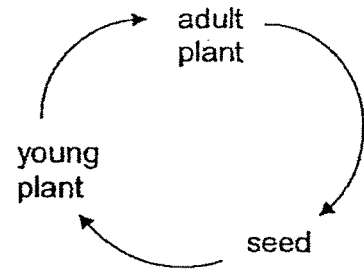

(3)

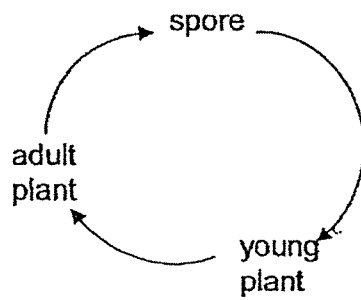

(4)

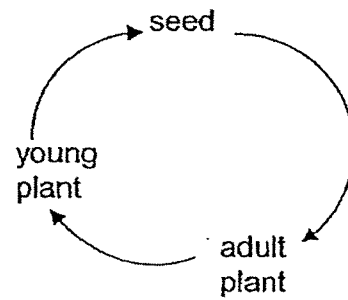

9. The following shows some characteristics of animal X.

X can live both on land and in water.  
X can breathe through its moist skin.

X belongs to the animal group of \_\_\_\_\_.

- (1) fish
- (2) bird
- (3) mammal
- (4) amphibian

10. Study the classification table below.

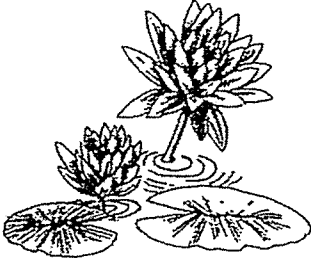
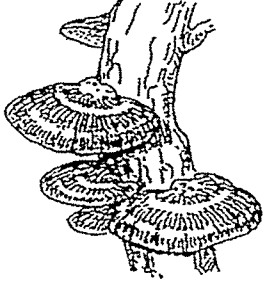
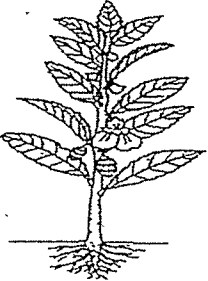
Living Things	
Group A	Group B
	
	

Based on how the living things are grouped, which set of headings is correct for Group A and B?

	Group A	Group B
(1)	Grow on land	Grow in water
(2)	Flowering plants	Non-flowering plants
(3)	Reproduce by seeds	Reproduce by spores
(4)	Do not make their own food	Make their own food

11. An experiment was conducted to find out how quickly heat was conducted through rods made of different materials. The set-up is as shown below.

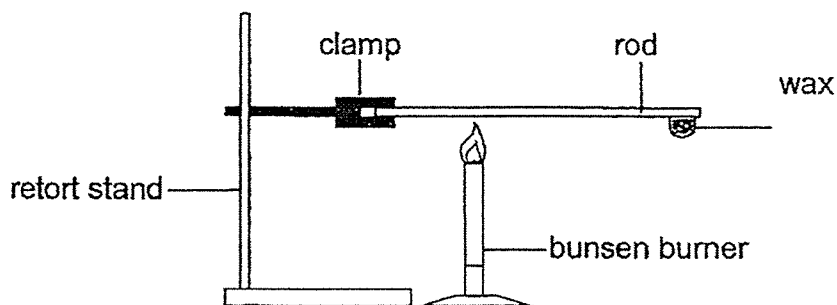

Using similar rods of different materials, the time taken for the wax to start melting is shown in the table below.

Material of rod	Time taken for wax to start melting (s)
P	66
Q	45
R	53
S	102

Based on the results above, which of the following shows the correct order of the materials from the best conductor of heat to the poorest conductor of heat?

	Best conductor of heat $\longrightarrow$ Poorest conductor of heat			
(1)	Q	R	P	S
(2)	R	S	Q	P
(3)	Q	P	R	S
(4)	S	P	R	Q

( )

Marks :

12

12. Paul filled three similar containers, X, Y and Z with the same amount of water. He put 3 similar plants, X, Y and Z into the containers and put them near a window. He recorded his observations in the table below.

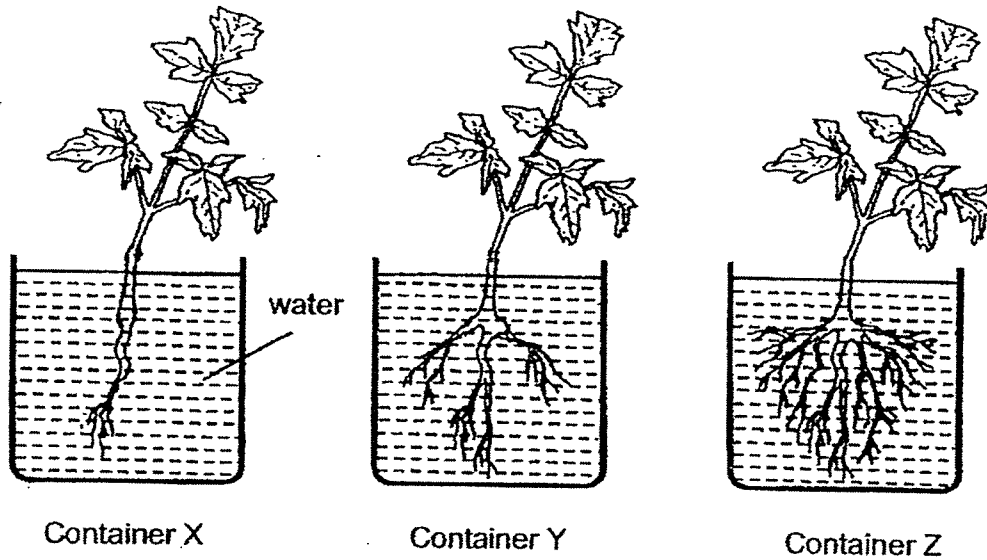

	Container X	Container Y	Container Z
Amount of water at the start (ml)	150	150	150
Amount of water after a week (ml)	140	120	100

Based on the observations recorded above, which one of the following statements is correct?

- (1) The roots help the plant to stay upright.
- (2) When there are less roots, more water is absorbed.
- (3) When there are more roots, more water is absorbed.
- (4) The number of roots does not affect the amount of water absorbed.



13. Mary observed animal X at the zoo.

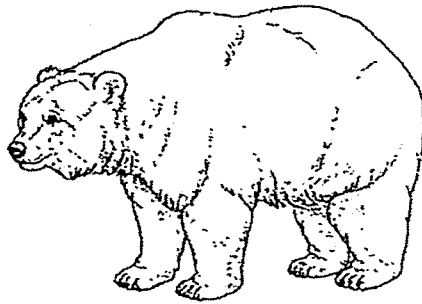

She made the following observations about animal X.

- A It has hair.
- B It lives on land.
- C It has four legs.
- D It suckles its young with milk.

Which of the following observations should she use to identify if it is a mammal?

- (1) A and B
- (2) A and D
- (3) B and C
- (4) C and D

14. Raju learnt that bacteria present in the air cause food to turn bad. The higher the surrounding temperature, the faster the food will turn bad.

Raju carried out an experiment using the 3 set-ups shown below.

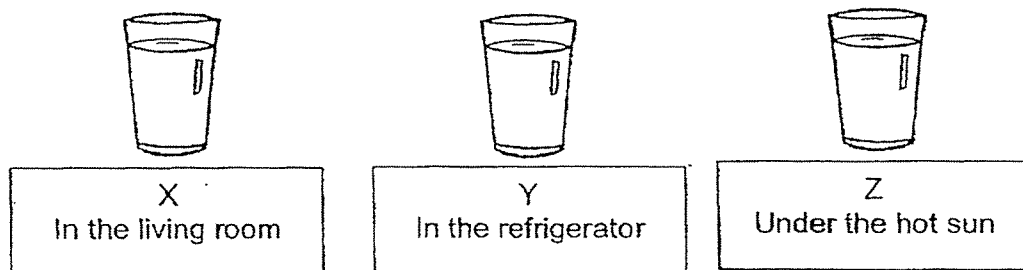

Which one of the following shows the correct order in which the milk in the set-ups turned bad, from the shortest time to the longest time?

- (1) X, Y, Z
- (2) X, Z, Y
- (3) Z, X, Y
- (4) Z, Y, X

15. Lisa placed eggs of animals P and Q into a box immediately after they were laid. The eggs were laid on the same day. The table below shows the stages and the number of days the animals remain at each stage.

Stage	Animal P	Animal Q
Egg	3 days	2 days
Larva	10 days	20 days
Pupa	20 days	30 days
Adult	1 year	2 years

When Lisa looked into the box 15 days later, what did she see?

- (1) pupae of animals P and Q
- (2) larvae of animals P and Q
- (3) pupae of animal P and larvae of animal Q
- (4) larvae of animal P and pupae of animal Q

16. Study the two groups of things, A and B, below.

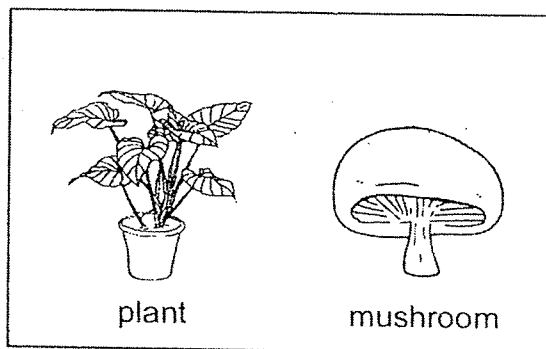

Group A

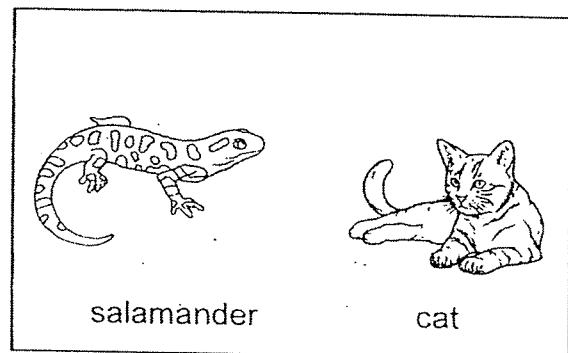

Group B

How are the things above classified?

- (1) Group A can make food but Group B cannot make food.
- (2) Group A are non-living things but Group B are living things.
- (3) Group A cannot respond to changes but Group B can respond to changes.
- (4) Group A cannot move from place to place but Group B can move from place to place.

17. The chart below shows how some objects are classified.

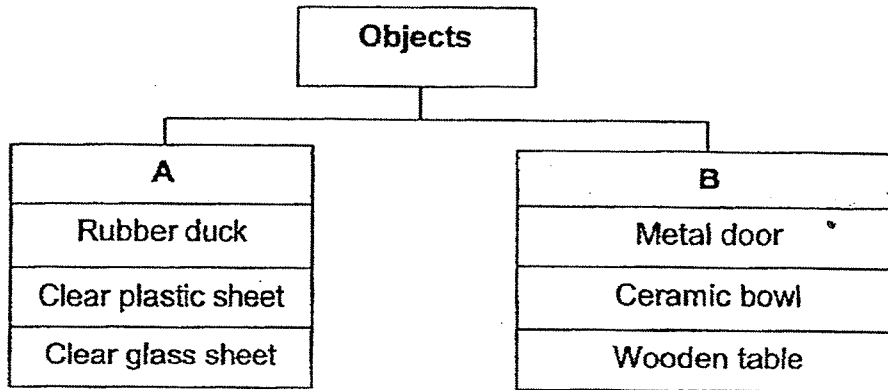

What object is placed wrongly in the classification chart?

- (1) Metal door
- (2) Rubber duck
- (3) Wooden table
- (4) Clear plastic sheet

18. Four identical sailboats were placed along a starting line. Different materials A, B, C and D were used for the sails.

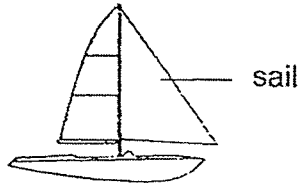

The time taken for each sailboat to reach the finishing line was recorded in the following table.

Material used for sail	Time taken to reach the finishing line(s)
A	25
B	40
C	60
D	35

Based on the results, which material allows the sailboat to travel the fastest?

- (1) A
- (2) B
- (3) C
- (4) D

19. The properties of four materials, A, B, C and D, are shown in the table below.

Material	Waterproof	Flexible	Allow light to pass through
A	✓	✓	✓
B		✓	✓
C	✓		✓
D	✓	✓	

Ahmad wanted to make part X of an umbrella, as shown below, to keep himself dry when it is raining and protect himself from the sun.



Based on the information above, Ahmad should use material \_\_\_\_\_ to make part X.

- (1) A
- (2) B
- (3) C
- (4) D

20. Jessie used four materials, P, Q, R, and S, of equal size to find out how well each material absorbed water using the experiment as shown.

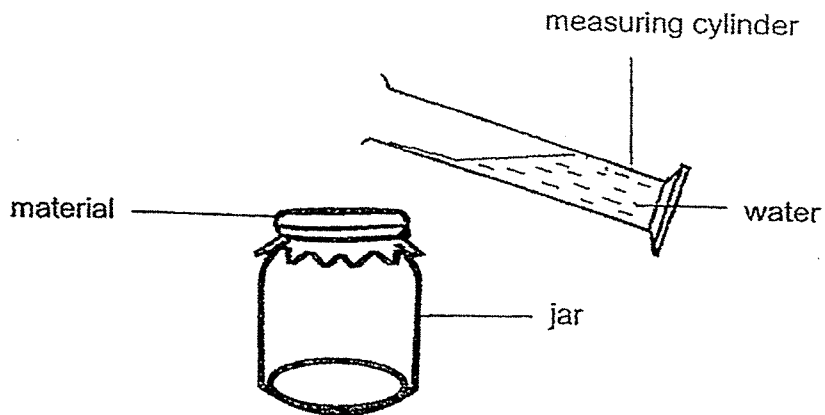

The experiment was repeated with 50 ml of water being poured through each material and the amount of water collected in each of the jar was recorded in the table below.

Mouth of jar covered with material	P	Q	R	S
Amount of water collected in the jar (ml)	45	15	0	30

Based on the information above, which one of the following materials would Jessie use to make a raincoat?

- (1) P
- (2) Q
- (3) R
- (4) S

21. The diagram below shows the mass of food eaten by an organism at different stages of its life cycle.

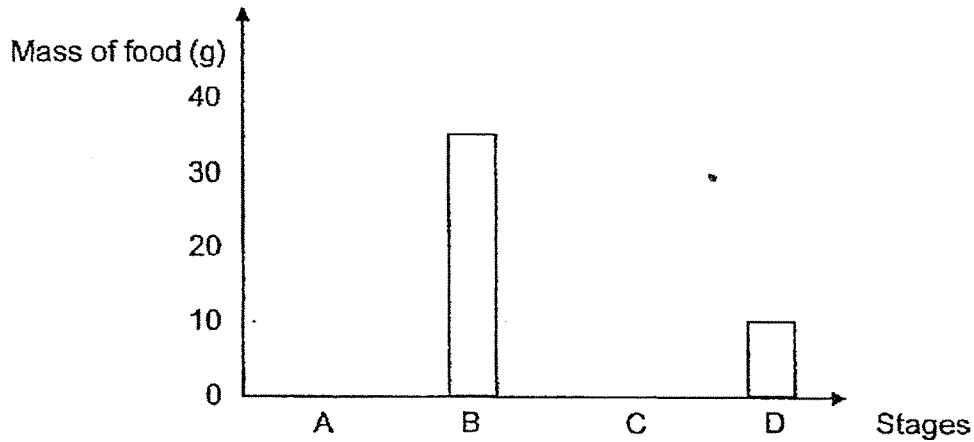

If stage A is the egg stage, which stage is the larval stage?

- (1) A
- (2) B
- (3) C
- (4) D

22. Three students made the following statements about the similarity between the life cycle of a chicken and a cockroach as shown below.

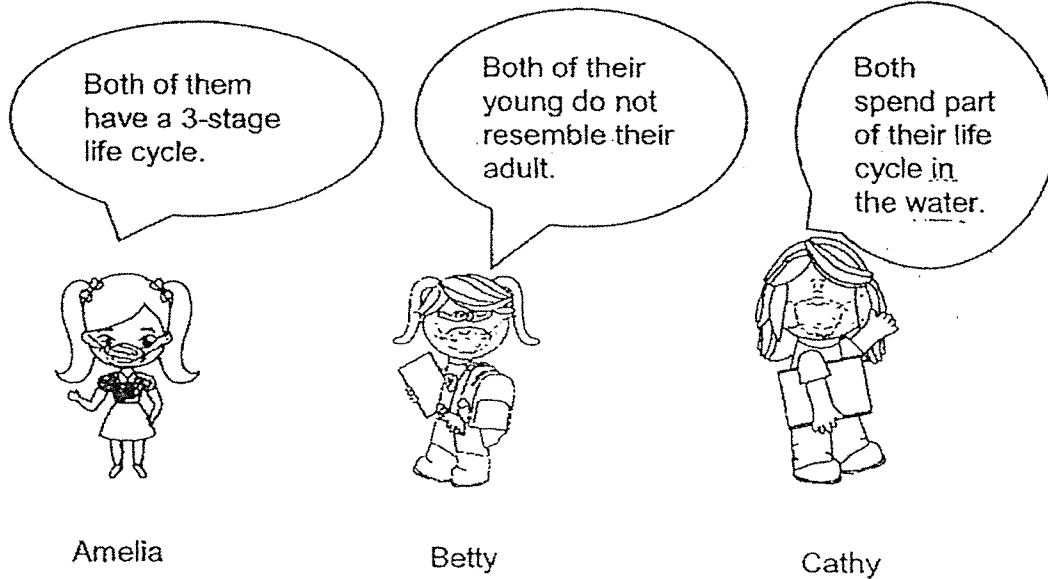

Which statement(s) made by the girl(s) is/are correct?

- (1) Amelia only
- (2) Cathy only
- (3) Amelia and Betty only
- (4) Betty and Cathy only

23. The graph below shows the change in the mass of one of the plant parts as the plant develops from a seedling into an adult plant.

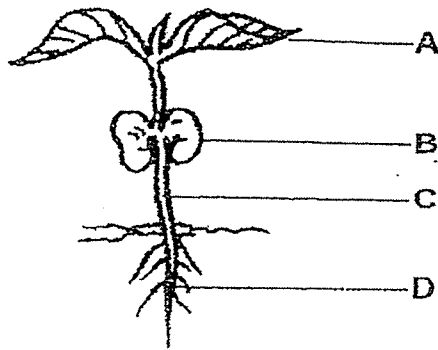
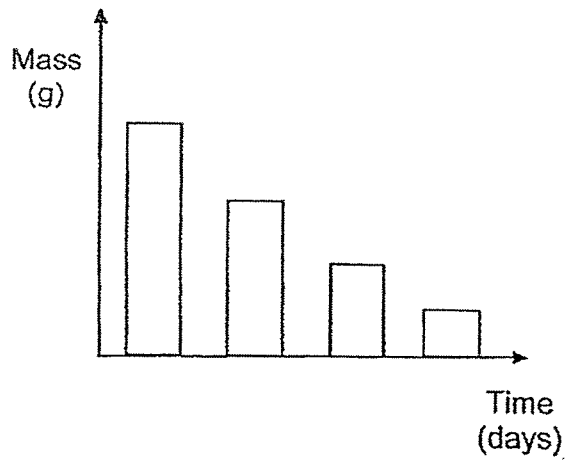

Which one of the above plant parts does the graph represent?

- (1) A
- (2) B
- (3) C
- (4) D

24. The diagram below shows a plant.

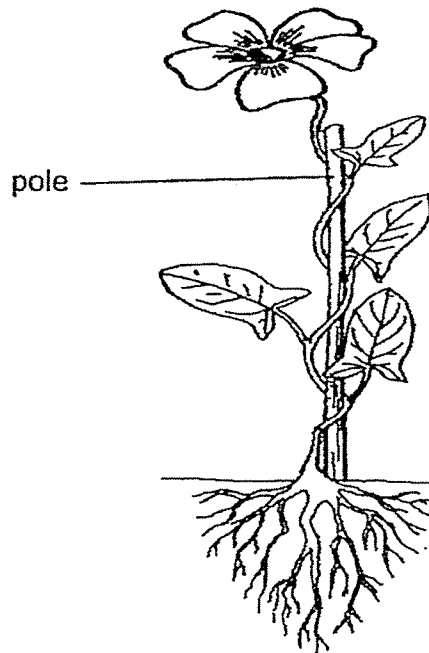

Samantha made the following statements.

- A This plant has spores.
- B This plant can make food.
- C This plant has a weak stem.
- D This plant is a flowering plant.

Which of the following statements is/are correct?

- (1) B only
- (2) A and C only
- (3) A, B and C only
- (4) B, C and D only

END OF SECTION A



**PAYA LEBAR METHODIST GIRLS' SCHOOL (PRIMARY)**

**END-OF-YEAR EXAMINATION, 2020**

**PRIMARY THREE**

**SCIENCE**

**BOOKLET B**

**NAME : \_\_\_\_\_ ( )**

**CLASS : P3 \_\_\_\_\_**

**DATE : 3 November 2020**

**TOTAL TIME FOR BOOKLETS A & B: 1 hour and 30 minutes**

<b>BOOKLET A</b>	<b>/ 48</b>
<b>BOOKLET B</b>	<b>' 32</b>
<b>TOTAL</b>	<b>/ 80</b>

Parent's Signature: \_\_\_\_\_

**INSTRUCTIONS TO PUPILS**

**DO NOT OPEN THIS BOOKLET UNTIL YOU ARE TOLD TO DO SO.**

**ANSWER ALL QUESTIONS.**

**SECTION B: 32 Marks**

For questions 25 to 34, write your answers in the spaces provided.

The number of marks available is shown in brackets [ ] at the end of each question or part question.

25. Match the living things to the group they belong to.

[3]

Living things

Group

 rose
 dog
 yeast

• fungi
• plant
• animal

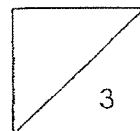

26. Fiona left a slice of sandwich on the table. After a few weeks, she saw some black patches growing on a sandwich.

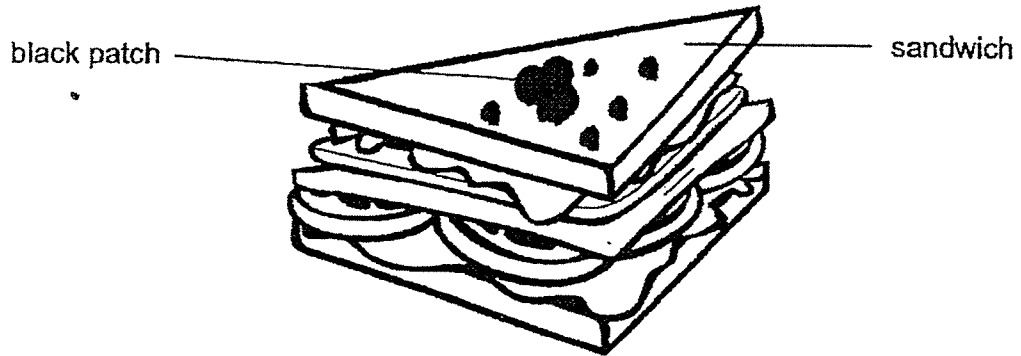

- (a) State what the black patches are. [1]

---

- (b) State the three conditions needed for the black patches to grow on the sandwich. [1]



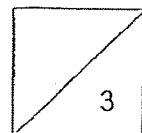

---

- (c) How does the black patches reproduce? [1]

---

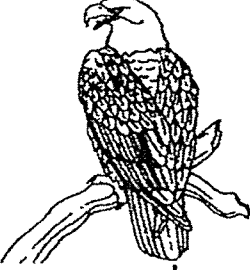

27. Some animals are classified according to their animal groups in the table as shown below.

Group S	Group T
 <p data-bbox="600 622 647 651">owl</p>	 <p data-bbox="927 622 1011 651">beetle</p>
 <p data-bbox="624 931 692 960">eagle</p>	 <p data-bbox="970 931 1023 960">ant</p>

(a) Name the animal group for Group S and Group T. [2]

Group S: \_\_\_\_\_

Group T: \_\_\_\_\_

(b) How do all the animals in the table above reproduce? [1]

\_\_\_\_\_

(c) What is the difference between the body covering of the animals in Group S and Group T? [1]

\_\_\_\_\_

\_\_\_\_\_

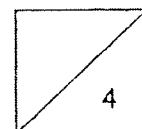

28. The diagram below shows a plant.

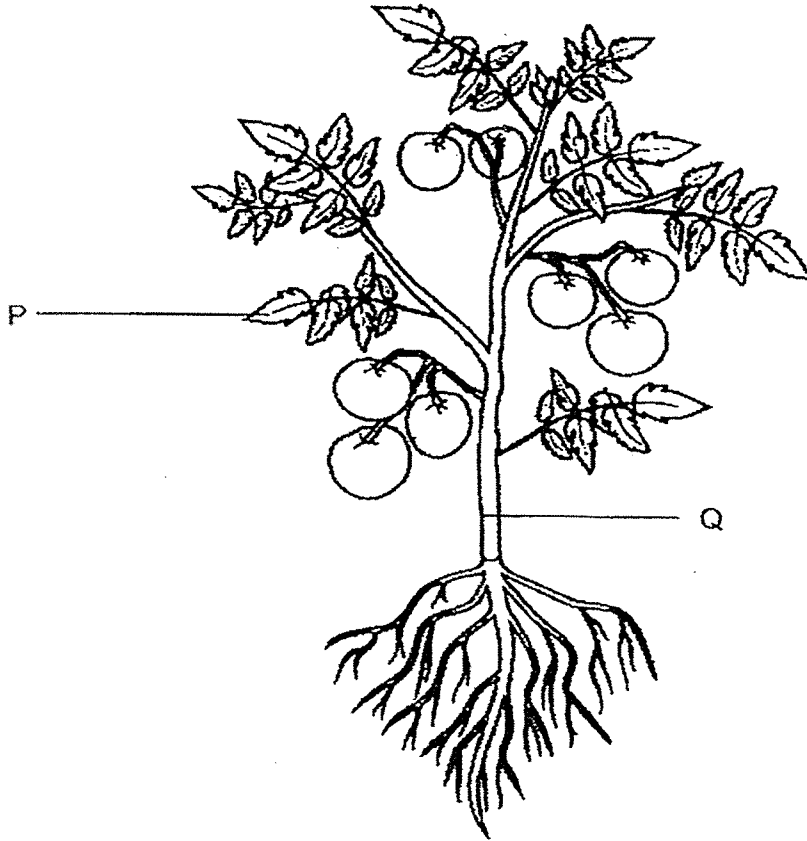

(a) Name part P and Q. [2]

Part P: \_\_\_\_\_

Part Q: \_\_\_\_\_

(b) State a function of Part P. [1]

\_\_\_\_\_  
\_\_\_\_\_

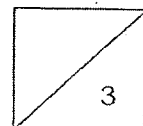

29. Andy wanted to find out if plants need sunlight to grow. He prepared 4 set-ups as shown below. He used the same type of plant and soil for each set-up.

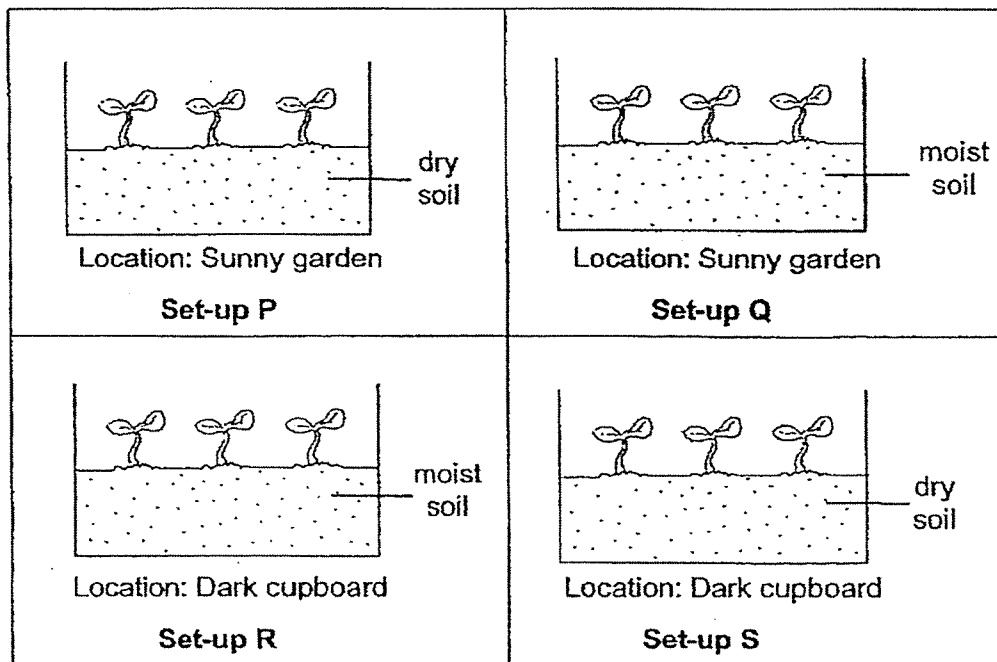

- (a) Which two set-ups should Andy choose in order to achieve his aim and to ensure a fair test? [1]

Set-ups \_\_\_\_\_ and \_\_\_\_\_

- (b) Explain your answer in (a). [2]

---



---

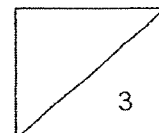

30. A, B, C and D show the various stages in the life cycle of a butterfly.

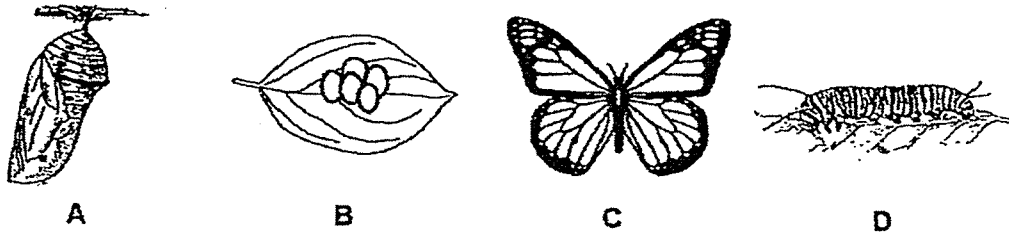

(a) Fill in the boxes below with A, B, C and D to show the correct sequence in the life cycle of a butterfly. [1]

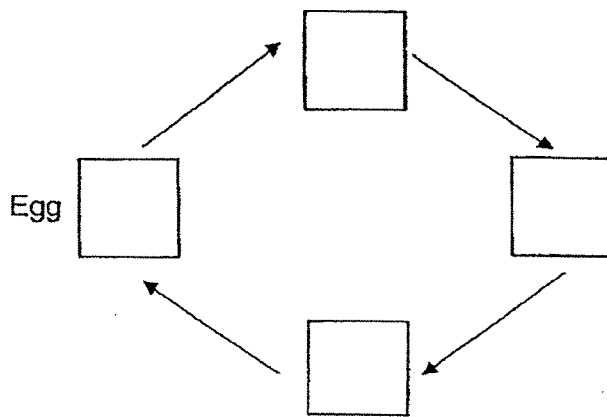

(b) State one difference between the butterfly in stage A and stage D of its life cycle. Do not compare the size, shape and colour. [1]

---



---

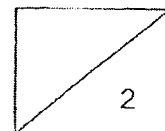

31. Tricia carried out an experiment as shown in the diagram below with three different planks A, B and C, of different materials, which were placed on top of two supports. Bricks were then stacked one at a time on the planks till it broke.

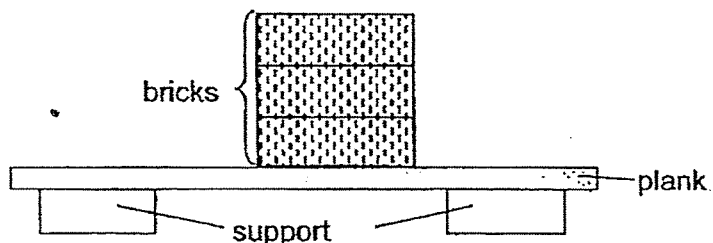

The table below shows the results of the experiment.

Plank	Number of bricks before the plank broke
A	8
B	20
C	2

- (a) State the property of material that the experiment is testing. [1]

Tricia wanted to make part X of a chair for a student to sit on as shown on the diagram below.

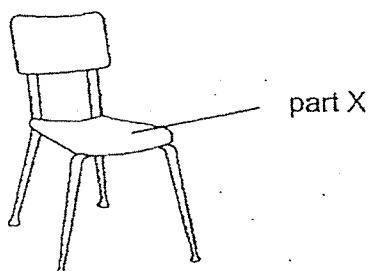

- (b) Which material, A, B or C should Tricia choose? Explain your answer. [2]

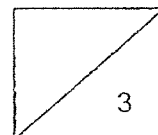



32. Alex planted a few green bean seeds in a pot. He placed the pot in a garden and watered it daily. He recorded the height of the seedlings as shown below.

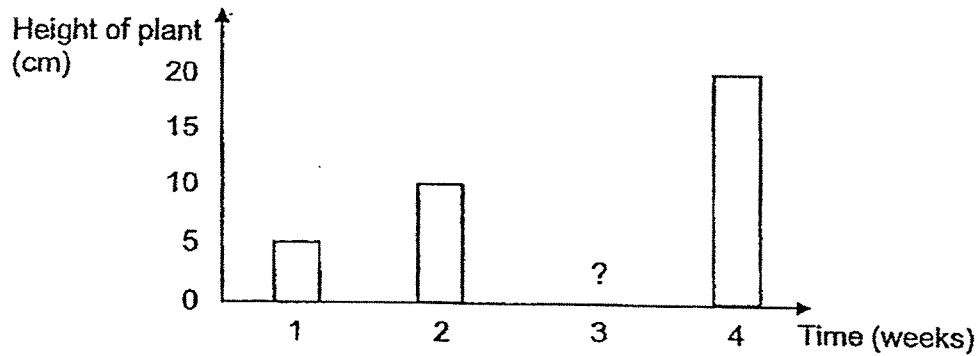

- (a) Based on the above results, which characteristic of living things does the experiment show? [1]

---

- (b) Predict the height of the plant in week 3. [1]

\_\_\_\_\_ cm

Alex found a bean pod in the garden.

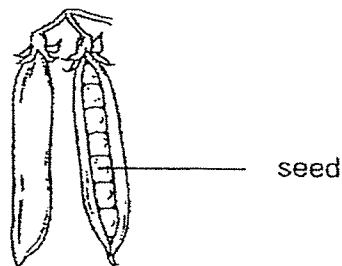

- (c) Alex says that the bean plant is a non-flowering plant. Do you agree with him? Why? [1]

---



---

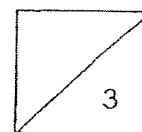

33. Study the life cycles of a frog and a mosquito carefully.

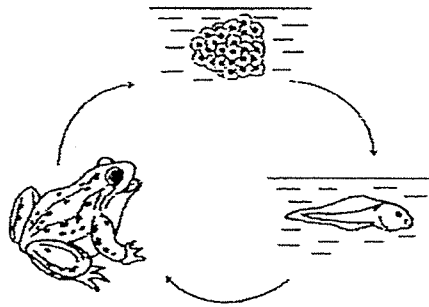

**Life cycle of a frog**

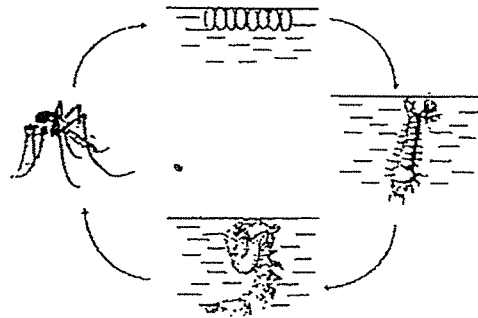

**Life cycle of a mosquito**

(a) State a similarity between the life cycle of a frog and that of a mosquito. [1]

---

(b) Mosquitoes can spread diseases. To prevent the spread of such diseases, people are encouraged to remove water from flowerpot plates on alternate days.

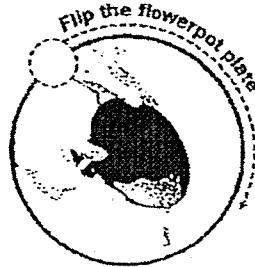

(i) At which stage of its life cycle is the mosquito most harmful to humans? [1]

---

(ii) How does removing water from flowerpot plates help prevent the spread of diseases by mosquitoes? [2]

---

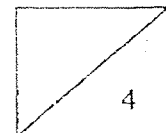

34. Study the chart below. It shows the properties of 4 different objects, A, B, C, and D:

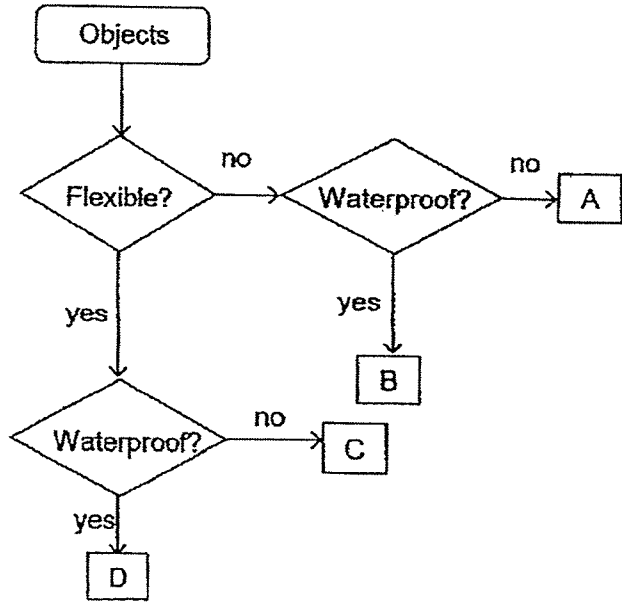

(a) Write down one similar property between object C and D. [1]

---

(b) Which object, A, B, C or D is most likely to be a piece of tissue paper? [1]

---

(c) Place objects, A, B, C and D, into 2 different groups, based on their properties, in the classification table below. Write a suitable heading for each group. [2]

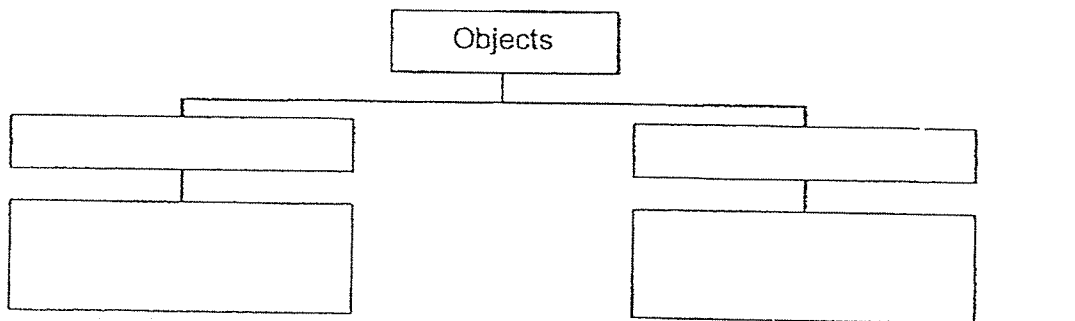

END OF SECTION B

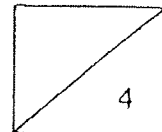

## ANSWER KEY

YEAR : 2020

LEVEL : PRIMARY 3

SCHOOL : METHODIST GIRLS' SCHOOL

SUBJECT : SCIENCE

TERM : END OF YEAR

### BOOKLET A

Q1	4	Q2	4	Q3	1	Q4	1	Q5	2
Q6	3	Q7	2	Q8	3	Q9	4	Q10	<del>4</del>
Q11	1	Q12	3	Q13	2	Q14	3	Q15	3
Q16	4	Q17	2	Q18	1	Q19	4	Q20	3
Q21	2	Q22	1	Q23	2	Q24	4		

### BOOKLET B

Q25	
Q26	<p>(a) they are mould</p> <p>(b) Water, air and warmth.</p> <p>(c) They reproduce by spores.</p>
Q27	<p>(a)</p> <p>Group S: Birds</p> <p>Group T: Insects</p> <p>(b) They reproduce by laying eggs.</p> <p>(c) Group S has feathers but Group T has hard outer coverings.</p>

Q28	(a) Part P: Leaves Part Q: Stem (b)Part P absorbs sunlight to make food.				
Q29	(a)Set-ups Q and R (b)Both Q and R have water.Set-up Q is put in a sunny garden with lots of sunlight while set-up R is put in a dark cupboard with no sunlight.				
Q30	(a) $B \rightarrow D \rightarrow A \rightarrow C$ b)In stage D, the animal eats a lot while in Stage A, it does not eat at all.				
Q31	(a)Strength (b)Material B. B took the number of bricks before the plank broke, so it is the strongest as it can hold a person's weight.				
Q32	(a)Living things grow (b)15cm (c)No. The bean plant has a seed so it means that it is a flowering plant.				
Q33	(a)They both lay eggs in water. (b) (i)The adult stage (ii)It prevents the mosquito from laying eggs in water / flower pot plates. Thus, preventing more adult mosquitos from developing.				
Q34	(a)Object C and D is flexible. (b)Object C (c)				
	<table border="1"> <tr> <td>Flexible</td> <td>Non-flexible</td> </tr> <tr> <td>D, C</td> <td>A, B</td> </tr> </table>	Flexible	Non-flexible	D, C	A, B
Flexible	Non-flexible				
D, C	A, B				